

Cupola Data
 Overall Height = 10'-4"
 Base Width = 4'
 Unit Weight = 275 lbs.

Base Panel: WP comes standard with 8 K-glass windows. See above for optional window designs.

Optional Window Panels

304

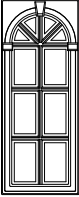

Keystone

311

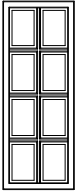

Squared

306

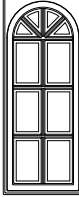

Round Top

Note: Windows also available without panes.

Optional Cupola Finials

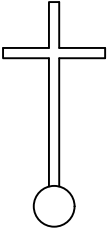

36" Cross
8"Ø Sphere



36" Aluminum Spire
8"Ø Sphere

Weathervane selection at :
www.whitehallproducts.com

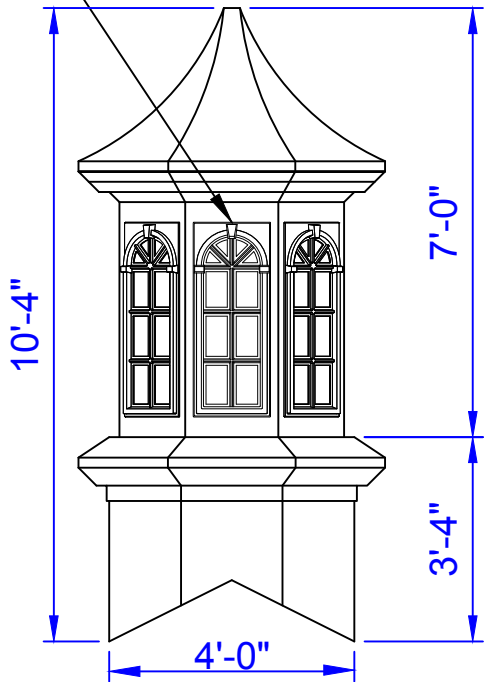

Elevation View

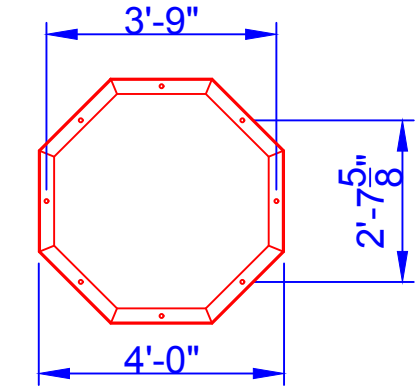

Mounting Detail

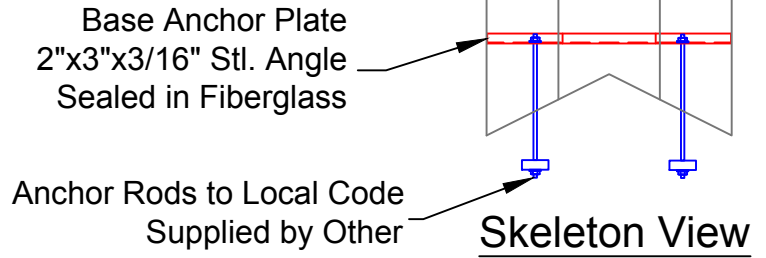

Skeleton View



PIEDMONT
 COMPOSITES & TOOLING

33 Lewittes Rd.
 Taylorsville, NC 28681
 Phone: 828-632-8883
 Fax: 828-632-5585
www.piedmontcomposites.com

Model :

CUPOLA
900WP

Scale:
 N/A
 Drawn by:
 C.BOTHOS
 Created On
 -
 Updated On
 03/27/19

Note: All drawings are the property of Piedmont Composites & Tooling, LLC. Variation in material thickness, dimension and weight may occur. PCT reserves the right to change or modify design at anytime without notice.