

Project:	
Date:	
Note:	

SIMPLY RELIABLE

LED PREMIUM FLAT PANEL 2'x4' TR50 SERIES



FEATURES

1. The panel has uniform and soft luminance, high luminous efficacy, saving energy and protecting environment.
2. Thickness is 0.38", extremely slim and beautiful.
3. Using high quality aluminum frame with great heat dissipation and low light degradation. Using PMMA LGP which has transmittance, so no color change within 10 years can be guaranteed.
4. Using high quality driver, efficiency $\geq 86\%$, PF ≥ 0.9 .
5. Lifespan $>50,000$ hours & 5 years warranty.
6. 1-10V dimming can be well compatible with all kinds of brand dimmers.
7. Dustproof: the distance between back cover and frame is nearly zero.

APPLICATIONS

The panel light is mainly used in indoor lighting places, such as office, factory, supermarket, schools, hospitality, Industrial Applications and so on.



SPECIFICATIONS		TR50-40W-24-40K-P	TR50-40W-24-50K-P
ORDERING	Brand	Builders Pack	Builders Pack
	SKU	57-19003-40	57-19003-50
GENERAL PERFORMANCE	Power Consumption	40W	40W
	Color Temp. (CCT)	4000K	5000K
	Lumens Delivered (lm)	5102 lm	5203 lm
	Efficacy (lm/W)	140.82 lm/W	143.53 lm/W
	LGP		MS
	CRI		≥ 80
	L70 Lifetime (Hours)		50,000 Hours
ELECTRICAL	Equivalency		80-120W MH
	Power Factor		≥ 0.9
	Input Voltage		AC 120-277V
PHYSICAL	Dimming		1-10V
	Mounting	Recessed Mount / Suspension Mount / Surface Mount with Kits	
	Operating Temp.	-4°F ~+ 113°F	
	Storage Temp.	-22°F ~+ 149°F	
QUALIFICATION	Ingress Protection (IP)	IP20	
	Certifications	ETL RoHS FCC CE	
	Material Usage	Aluminum Frame & Frosted Diffuser	
	Environment	Indoor	
DIMENSIONS (Package Subjecting to Change)	Warranty	5 years	
	Product Size	47.72" x 23.74" x 1.80"	
	Gross Weight	6.835 lbs	

Project:	
Date:	
Note:	

INSTALLATION DIAGRAM

RECESSED INSTALLATION

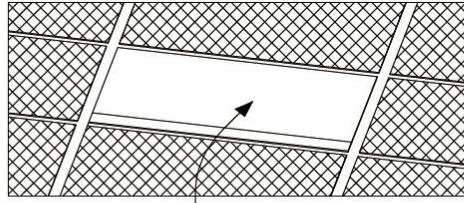

1. Replace existing lighting fixture from ceiling with LED Panel.

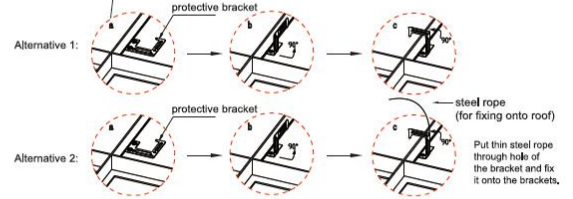
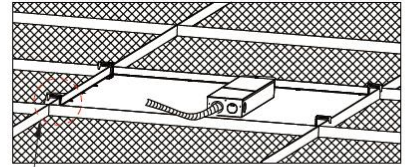

2. Use the protective brackets for safety.

SUSPENSION KIT INSTALLATION

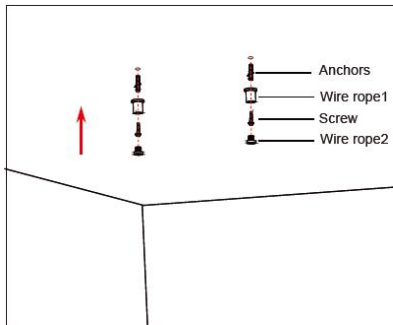

1. Drill two holes in the ceiling, and put the anchors into hole, then insert the wire rope and screw.

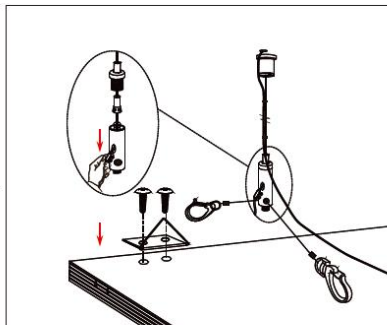

2. Adjusting the hanging rope making the panel in a horizontal state.



3. The installation is finished.

Note: 2*2ft: 2 pcs suspension kits needed for installation. 1*4ft and 2*4ft: 3pcs suspension kits needed for installation.

SURFACE MOUNTED INSTALLATION

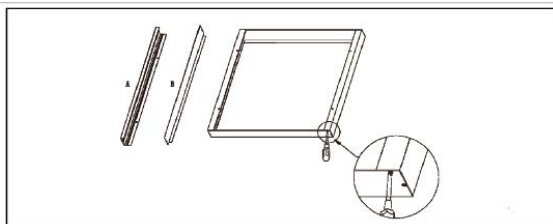

1. Assemble the frame using screws.

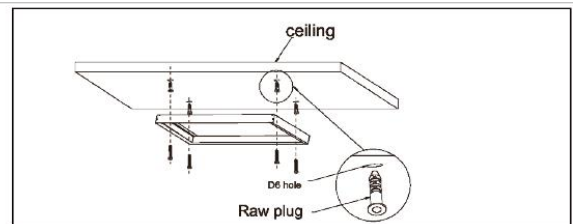

2. Drill 4 D6mm holes on the ceiling, install the raw plug and fix the frame on the ceiling.

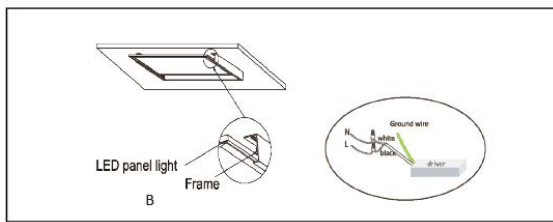

3. A. Remove a frame B
B. Connect the wires with the reference to the above the picture.

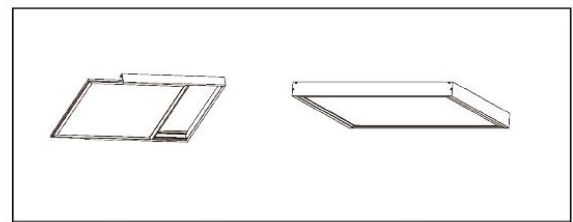

4. A. Push the panel into the frame from the open side.
B. Put the driver and all the wires on the back of the panel;
C. Install the previously removed Frame B back.

Project:	
Date:	
Note:	



SIMPLY RELIABLE

DISTRIBUTION CURVE																			
	<table border="1" style="margin: auto;"> <thead> <tr> <th></th> <th>Center Beam fc</th> <th>Beam Width</th> </tr> </thead> <tbody> <tr> <td>4.0ft</td> <td>115.2 fc</td> <td>12.1 ft 12.2 ft</td> </tr> <tr> <td>8.0ft</td> <td>28.8 fc</td> <td>24.3 ft 24.5 ft</td> </tr> <tr> <td>12.0ft</td> <td>12.8 fc</td> <td>36.4 ft 36.7 ft</td> </tr> <tr> <td>16.0ft</td> <td>7.2 fc</td> <td>48.5 ft 48.9 ft</td> </tr> <tr> <td>20.0ft</td> <td>4.6 fc</td> <td>60.7 ft 61.2 ft</td> </tr> </tbody> </table> <p> ■ Vert. Spread: 113.2° ■ Horiz. Spread: 113.6° </p>			Center Beam fc	Beam Width	4.0ft	115.2 fc	12.1 ft 12.2 ft	8.0ft	28.8 fc	24.3 ft 24.5 ft	12.0ft	12.8 fc	36.4 ft 36.7 ft	16.0ft	7.2 fc	48.5 ft 48.9 ft	20.0ft	4.6 fc
	Center Beam fc	Beam Width																	
4.0ft	115.2 fc	12.1 ft 12.2 ft																	
8.0ft	28.8 fc	24.3 ft 24.5 ft																	
12.0ft	12.8 fc	36.4 ft 36.7 ft																	
16.0ft	7.2 fc	48.5 ft 48.9 ft																	
20.0ft	4.6 fc	60.7 ft 61.2 ft																	
SHIPPING <small>(Package Subjecting to Change)</small>	Pcs / Carton	2pcs																	
	Master Carton Size	48.82" x 3.19" x 25.20"																	
	Pcs / Pallet	72pcs																	
	Pcs / 20' GP	842pcs (No Pallet) 780pcs (Palletized)																	
	Pcs / 40' GP	1686pcs (No Pallet) 1592pcs (Palletized)																	
	Pcs / 40' HQ	2124pcs (No Pallet) 2000pcs (Palletized)																	
	Pcs / 45' HQ	2280pcs (No Pallet) 2186pcs (Palletized)																	

LAMP CODE DEFINITIONS				
Category	Wattage	Size	CCT	Listing
TR50 = Panel	40W	24 = 2' x 4'	40K = 4000K 50K = 5000K	P = Premium

Project:	
Date:	
Note:	

ACCESSORIES

SKU	Description	Image
79-92013	LED Emergency Power Supply 8W	
ES19045-3	Cable Kit for Flat Panel 1' x 4' / 2' x 4'	
73-19003-A	Surface Mount Kit for Flat Panel 2' x 4'	