

Distributor Systems, Diffusers, Tank Heads, Brine valves etc for FRP Tanks Distributors

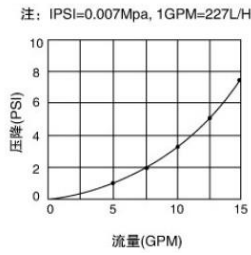

H2805

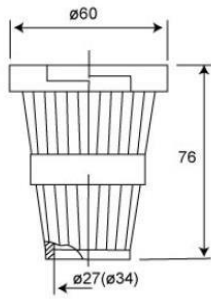
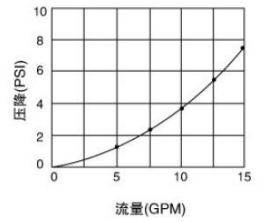
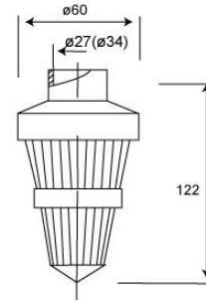

H2807

Product Code	Specification	Tanks
H2805	3/4" Top distributor for Fleck	6"-12"/Ø150-300mm
H2807	3/4" Bottom distributor for Fleck	6"-12"/Ø150-300mm

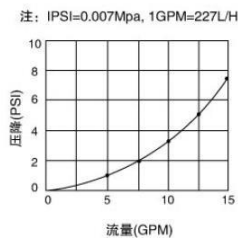
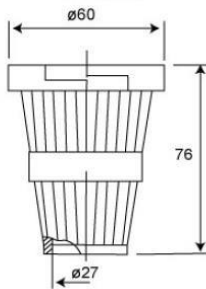

H2805NT

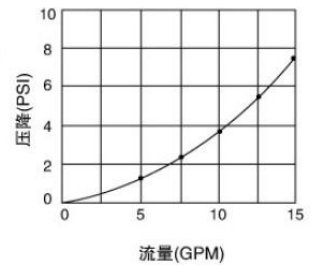
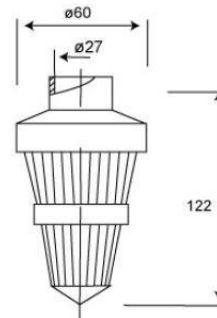

H2807NT

Product Code	Specification	Tanks
H2805-NT	3/4" Top distributor for Fleck	6"-12"/Ø150-300mm
H2807-NT	3/4" Bottom distributor for Fleck	6"-12"/Ø150-300mm

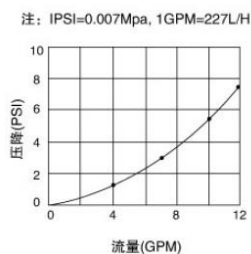
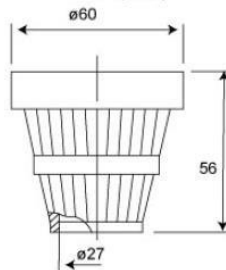

H2801-A

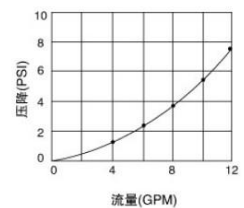
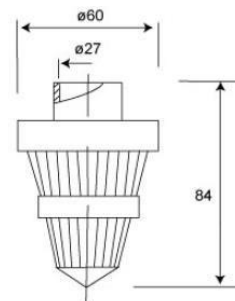

H2803

Product Code	Specification	Tanks
H2801-A	3/4" Top distributor for Autotrol	6"-12"/Ø150-300mm
H2803	3/4" Bottom distributor for Autotrol	6"-12"/Ø150-300mm

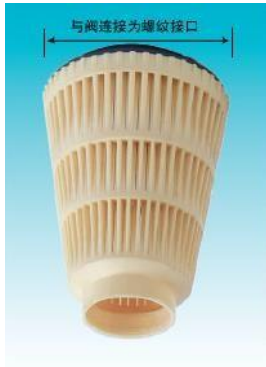

HD219

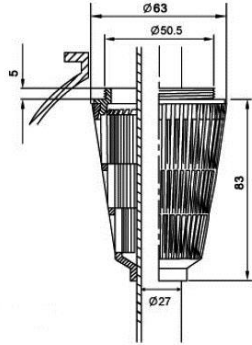

HD239

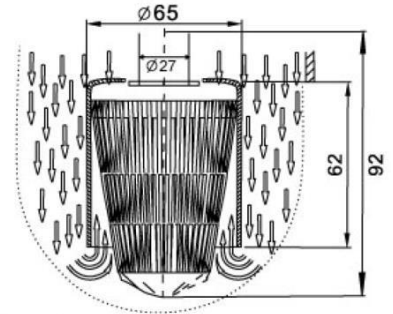

Product Code	Specification	Tanks
HD219	3/4" Top distributor threaded type	6"-12"/ $\varnothing 150-300\text{mm}$
HD239	3/4" Bottom distributor glue type	6"-12"/ $\varnothing 150-300\text{mm}$



H2809

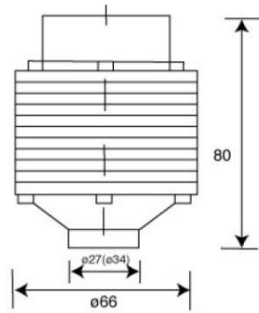

H2810

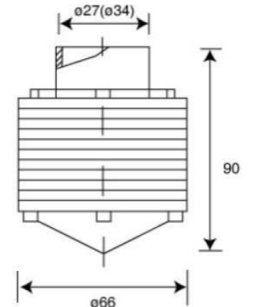

Product Code	Specification	Tanks
H2809	3/4" Top distributor stack	8"-16"/@200-400mm
H2809-GT	3/4" Top distributor stack, glue type	8"-16"/@200-400mm
H2810	3/4" bottom distributor stack	8"-16"/@200-400mm



HD232/ HD233

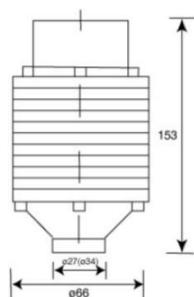

H2809-L, H2810-L

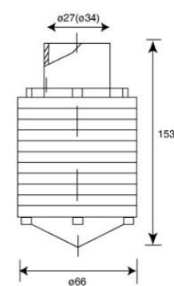

Product Code	Specification	Tanks
H2809-L	3/4" Top distributor stack L type	6"-16"/@150-400mm
H2810-L	3/4" bottom distributor stack L type	6"-16"/@150-400mm
HD232	1" Top distributor stack	8"-20"/@200-500mm
HD233	1" bottom distributor stack	8"-20"/@200-500mm

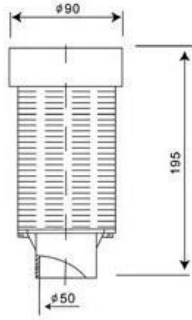

H182



H182-1



H2808

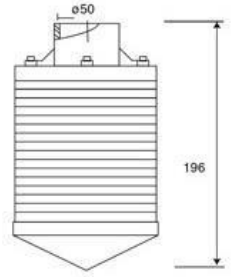

Product Code	Specification	Tanks
H182	1.5" top distributor stack	12"-36"/@300-910mm
H182-1	1.5" top distributor stack	12"-36"/@300-910mm
H2808	1.5" bottom distributor stack	12"-36"/@300-910mm



HD234

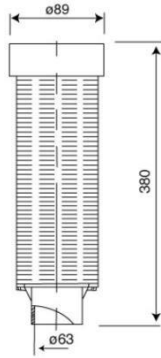

HD216

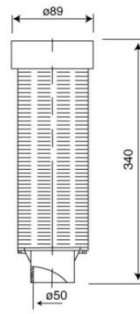

H182-1L

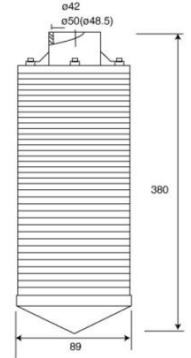

Product Code	Specification	Tanks
HD234	2" top distributor stack for Fleck 3150	30"-60"/@750-1500mm
HD216	1.5" top distributor stack for Runxin valves	30"-60"/@750-1500mm
H182-1L	1.5" bottom distributor stack L type	24"-40"/@600-1000mm



HD203

HD204

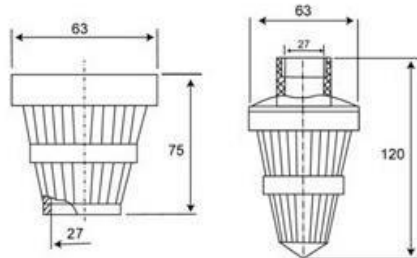

KDF-225

Product Code	Specification	Tanks
WHD203	3/4" Top distributor glue type	6"-12"/Ø150-300mm
HD204	3/4" Bottom distributor glue type	6"-12"/Ø150-300mm

Top Mount Distributor 6 laterals

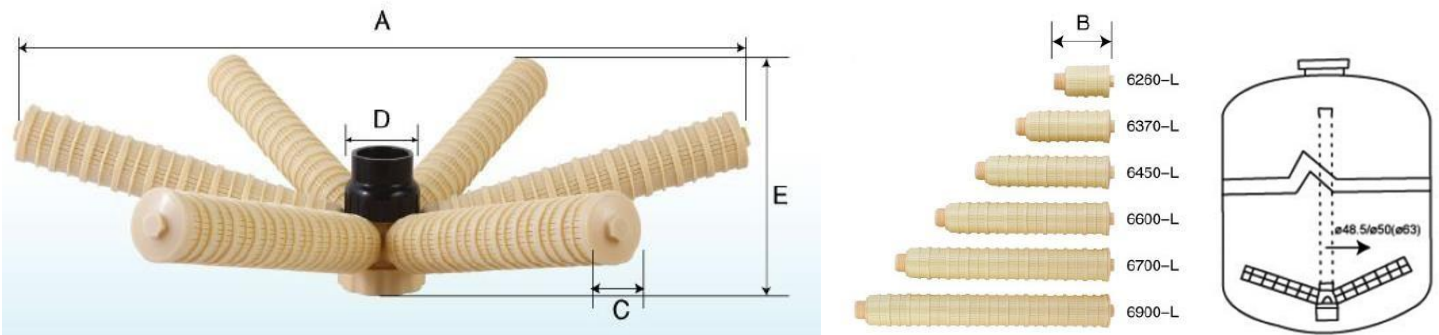

Product Code	Dimensions (mm)				Tanks	Top Opening	Slot Size
	A	B	C	D			
HU6260L	260	82	53	50/42	16"-18"/Ø400-450mm	4"-8UN	0.2/0.25/0.4mm
HU6370L	370	136	53	50/42	18"-21"/Ø450-550mm	4"-8UN	0.2/0.25/0.4mm
HU6450L	450	182	53	50/42	24"/Ø600mm	4"-8UN	0.2/0.25/0.4mm
HU6600L	620	260	53	50/63	30"/Ø750mm	4"-8UN	0.2/0.25/0.4mm
HU6700L	710	330	53	50/63	36"-42"/Ø900-1050mm	4"-8UN	0.2/0.25/0.4mm
HU6900L	930	410	53	50/63	48"/Ø1200mm	4"-8UN	0.2/0.25/0.4mm

Top Mount Distributor 12 laterals

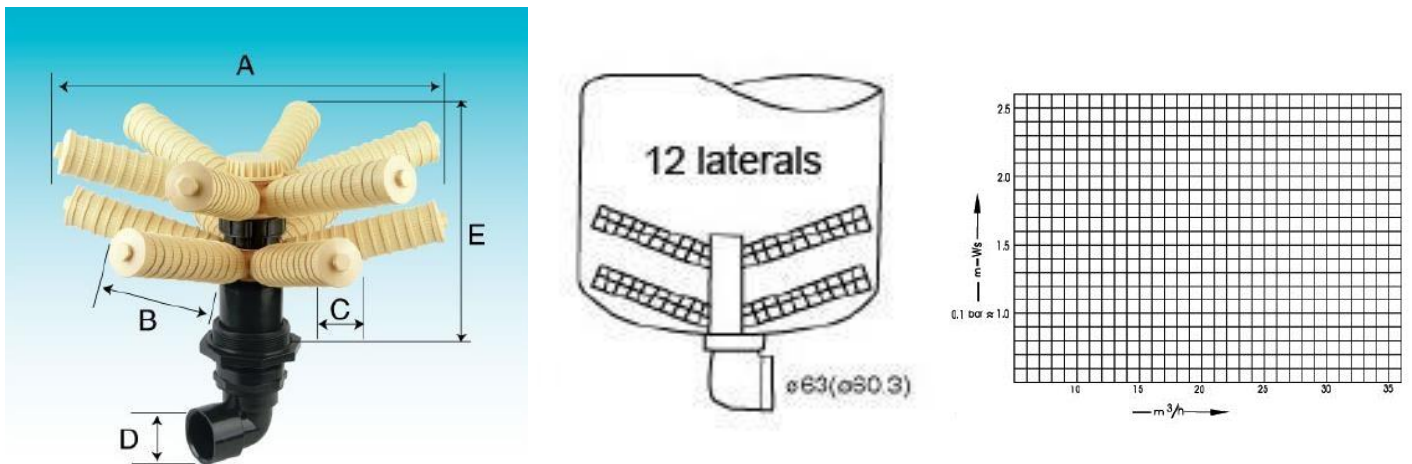

Product Code	Dimensions (mm)				Tanks	Top Opening	Slots
	A	B	C	D			
HU6700L-2	710	330	53	63	36"-42"/Ø900-1050mm	4"-8UN	0.2/0.25/0.4mm
HU6900L-2	930	410	53	63	48"/Ø1200mm	4"-8UN	0.2/0.25/0.4mm

Top Mount Distributor 8 laterals, 3" riser tube

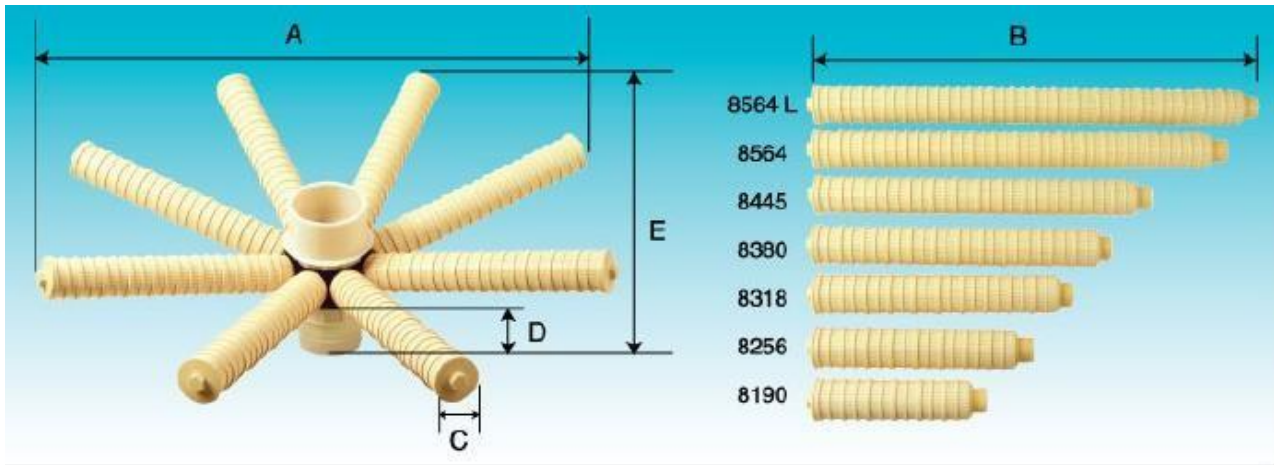

Product Code	Dimensions (mm)			Tanks	Top Opening	Slot Size
	A	B	C			
HU8190-1	512	190	53	24"/Ø600mm	6" FLG	0.2/0.25/0.4mm
HU8256-1	630	256	53	30"/Ø750mm	6" FLG	0.2/0.25/0.4mm
HU8318-1	750	318	53	36"/Ø900mm	6" FLG	0.2/0.25/0.4mm
HU8380-1	870	380	53	40"-42"/Ø1000-1050mm	6" FLG	0.2/0.25/0.4mm
HU8445-1	980	445	53	48"/Ø1200mm	6" FLG	0.2/0.25/0.4mm
HU8564-1	1218	564	53	56-65"/Ø1400-1600mm	6" FLG	0.2/0.25/0.4mm
HU8564L-1	1345	640	53	65-80"/Ø1600-2000mm	6" FLG	0.2/0.25/0.4mm

Top Mount Distributor 16 laterals, 3" riser tube

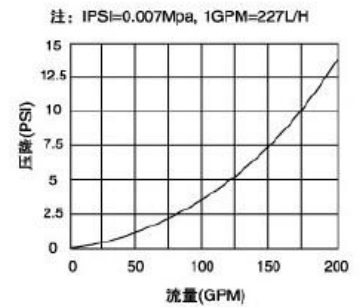
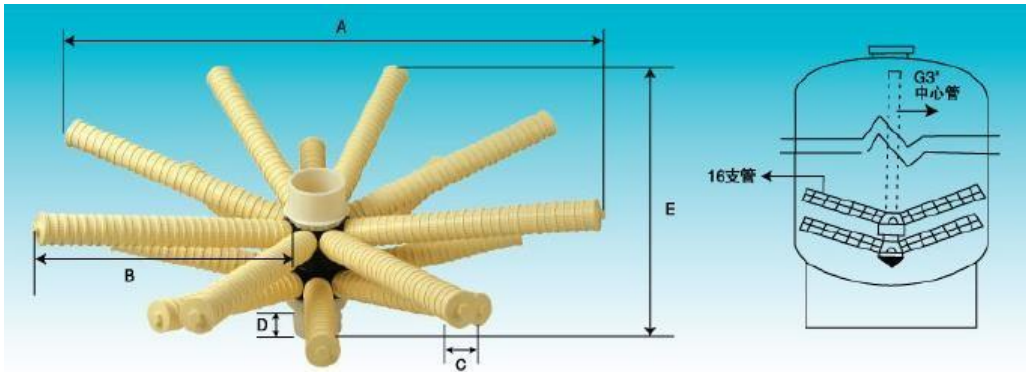

Product Code	Dimensions (mm)			Tanks	Top Opening	Slot Size
	A	B	C			
HU8190-2	512	190	53	24"/Ø600mm	6" FLG	0.2/0.25/0.4mm
HU8256-2	630	256	53	30"/Ø750mm	6" FLG	0.2/0.25/0.4mm
HU8318-2	750	318	53	36"/Ø900mm	6" FLG	0.2/0.25/0.4mm
HU8380-2	870	380	53	40"-42"/Ø1000-1050mm	6" FLG	0.2/0.25/0.4mm
HU8445-2	980	445	53	48"/Ø1200mm	6" FLG	0.2/0.25/0.4mm
HU8564-2	1218	564	53	56-65"/Ø1400-1600mm	6" FLG	0.2/0.25/0.4mm
HU8564L-2	1345	640	53	65-80"/Ø1600-2000mm	6" FLG	0.2/0.25/0.4mm

4" Threaded Side Mount Top Diffuser

Product Code	Tanks	Top & Bottom Opening
H5671	14"-30"/Ø350-750mm	4"-8UN
H5671L	30"-40"/Ø750-1000mm	4"-8UN
H5672L	36"-40"/Ø900-1000mm	4"-8UN

Product Code	Dimensions (mm)			Slot Size
	A	B	C	
H5671	180	400	88	0.2/0.4mm
H5671L	242	472	88	0.2/0.4mm
H5672L	310	540	88	0.2/0.4mm



Remark: elbow size D both Ø63 and Ø60.3 available

Product Code	Tanks	Top & Bottom Opening
H5671-N	14"-30"/Ø350-750mm	4"-8UN
H5671L-N	30"-40"/Ø750-1000mm	4"-8UN
H5672L-N	36"-40"/Ø900-1000mm	4"-8UN

Product Code	Dimensions (mm)			Slot Size
	A	B	C	
H5671-N	180	400	88	0.2/0.4mm
H5671L-N	242	472	88	0.2/0.4mm
H5672L-N	310	540	88	0.2/0.4mm

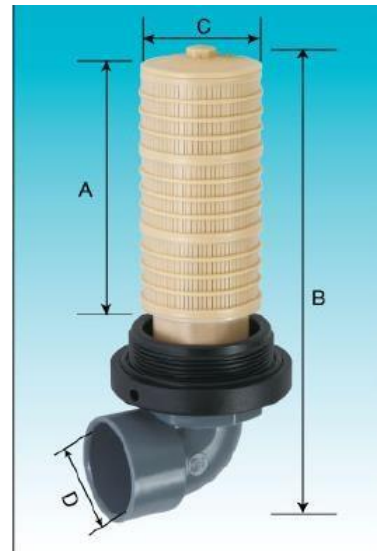

Remark: elbow size D both Ø63 and Ø60.3 available

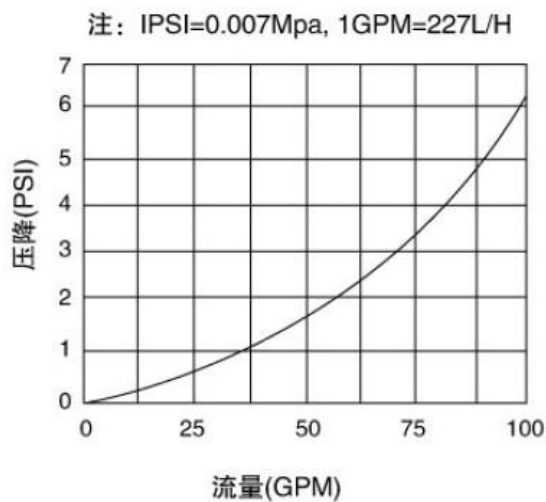
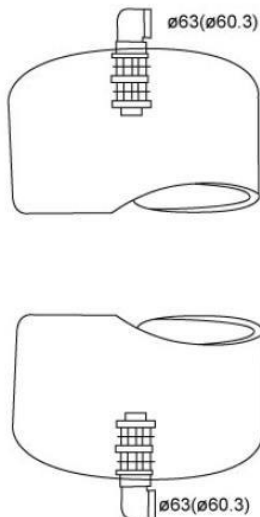

Side Mount Distributor 6 laterals

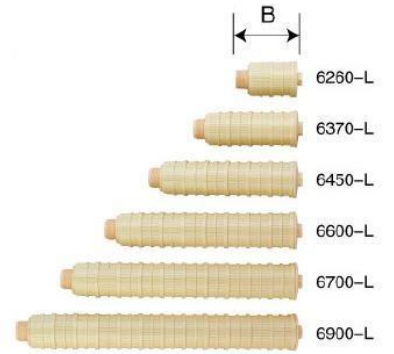
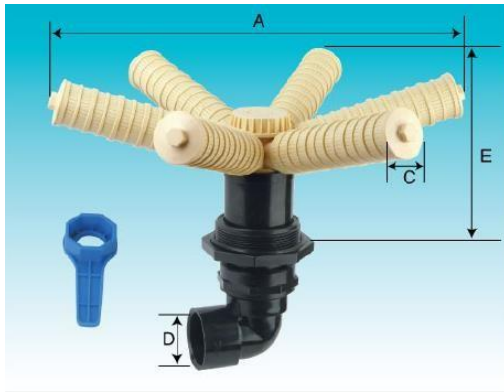

Product Code	Dimensions (mm)				Tanks	Top & Bottom Opening	Slot Size
	A	B	C	D			
HD6260L	260	82	53	63	16"-18"/Ø400-450mm	4"-8UN	0.2/0.25/0.4mm
HD6370L	370	136	53	63	18"-21"/Ø450-550mm	4"-8UN	0.2/0.25/0.4mm
HD6450L	450	182	53	63	24"/Ø600mm	4"-8UN	0.2/0.25/0.4mm
HD6600L	620	260	53	63	30"/Ø750mm	4"-8UN	0.2/0.25/0.4mm
HD6700L	710	330	53	63	36"-42"/Ø900-1050mm	4"-8UN	0.2/0.25/0.4mm
HD6900L	930	410	53	63	48"/Ø1200mm	4"-8UN	0.2/0.25/0.4mm

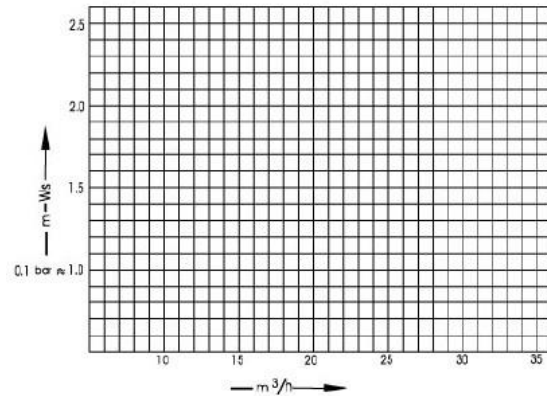
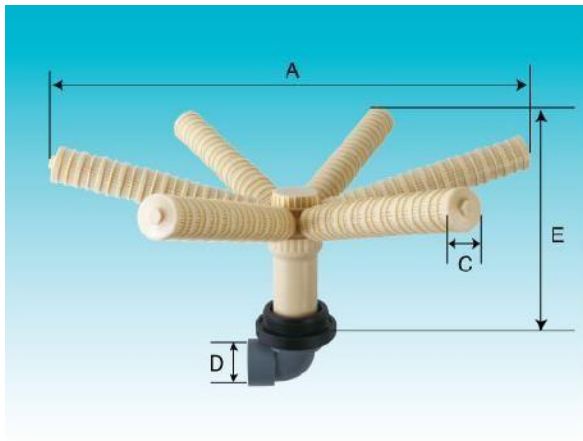

Product Code	Dimensions (mm)				Tanks	Top & Bottom Opening	Slot Size
	A	B	C	D			
HD6260L-N	260	82	53	63	16"-18"/Ø400-450mm	4"-8UN	0.2/0.25/0.4mm
HD6370L-N	370	136	53	63	18"-21"/Ø450-550mm	4"-8UN	0.2/0.25/0.4mm
HD6450L-N	450	182	53	63	24"/Ø600mm	4"-8UN	0.2/0.25/0.4mm
HD6600L-N	620	260	53	63	30"/Ø750mm	4"-8UN	0.2/0.25/0.4mm
HD6700L-N	710	330	53	63	36"-42"/Ø900-1050mm	4"-8UN	0.2/0.25/0.4mm
HD6900L-N	930	410	53	63	48"/Ø1200mm	4"-8UN	0.2/0.25/0.4mm

Side Mount Distributor 12 laterals

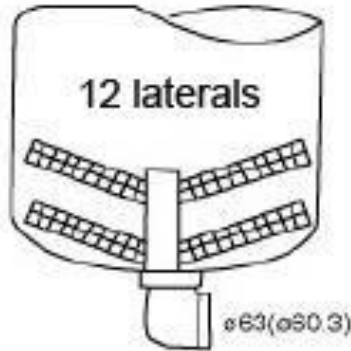
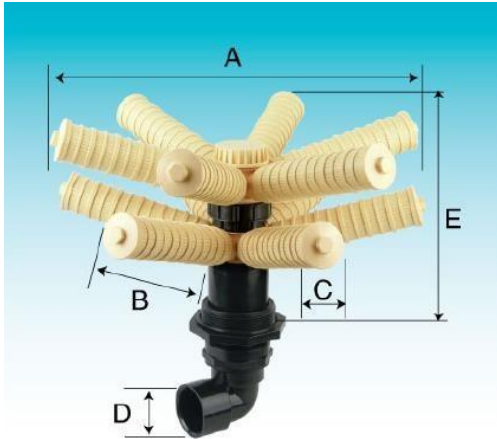

Product Code	Dimensions (mm)				Tanks	Top & Bottom Opening	Slot Size
	A	B	C	D			
HD6700L-2	710	330	53	63	36"-42"/ $\varnothing 900-1050\text{mm}$	4"-8UN	0.2/0.25/0.4mm
HD6900L-2	930	410	53	63	48"/ $\varnothing 1200\text{mm}$	4"-8UN	0.2/0.25/0.4mm

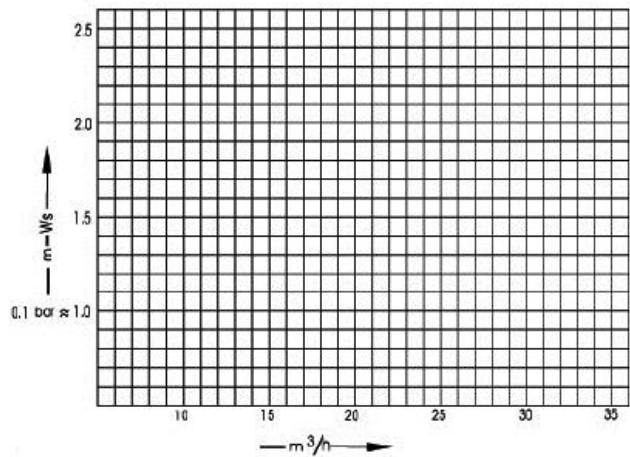
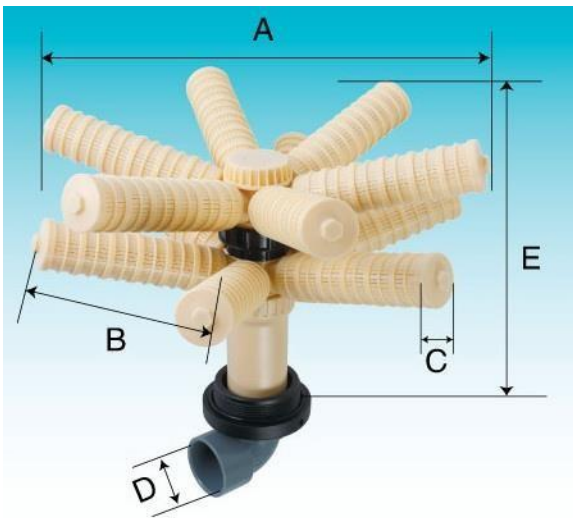

Product Code	Dimensions (mm)				Tanks	Top & Bottom Opening	Slot Size
	A	B	C	D			
HD6700L-2N	710	330	53	63	36"-42"/ $\varnothing 900-1050\text{mm}$	4"-8UN	0.2/0.25/0.4mm
HD6900L-2N	930	410	53	63	48"/ $\varnothing 1200\text{mm}$	4"-8UN	0.2/0.25/0.4mm

6" Flanged Top Mount Diffuser

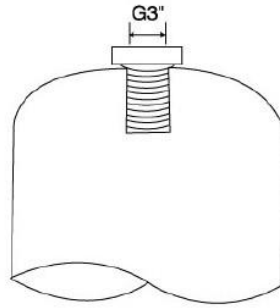
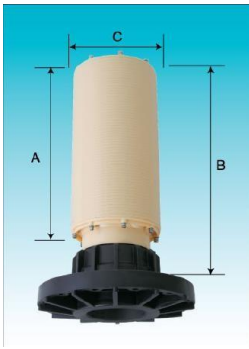

Product Code	Dimensions (mm)			Tanks	Top & Bottom Opening	Slot Size
	A	B	C			
H172	260	360	140	36"-48"/Ø900-1200mm	6" FLG	0.25mm
H173	330	420	140	48"-64"/Ø1200-1600mm	6" FLG	0.25mm
H174	430	520	140	64"-80"/Ø1600-2000mm	6" FLG	0.25mm

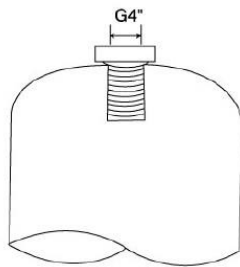
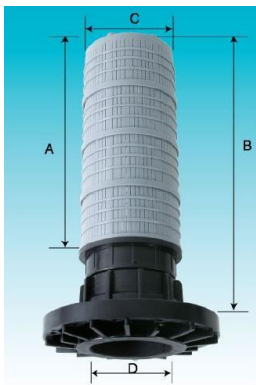

Product Code	Dimensions (mm)				Tanks	Top & Bottom Opening	Slot Size
	A	B	C	D			
H175	340	440	140	110	40"-80"/Ø1000-2000mm	6" FLG	0.25mm

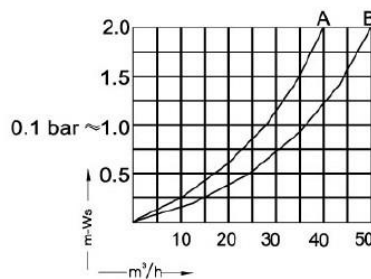
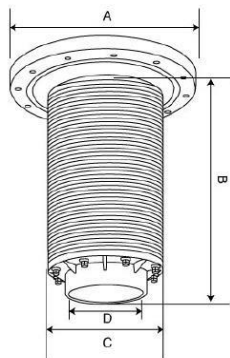

Top Distributor for Fleck 3900

Product Code	Dimensions (mm)				Tanks	Top & Bottom Opening	Slot Size
	A	B	C	D			
HD10300F	240	440	140	90	36"-60"/Ø900-1500mm	6" FLG	0.25/0.4mm
HD10400F	240	540	140	90	60"-80"/Ø1500-2000mm	6" FLG	0.25/0.4mm

6" Flanged Top Mount Diffuser 3 laterals

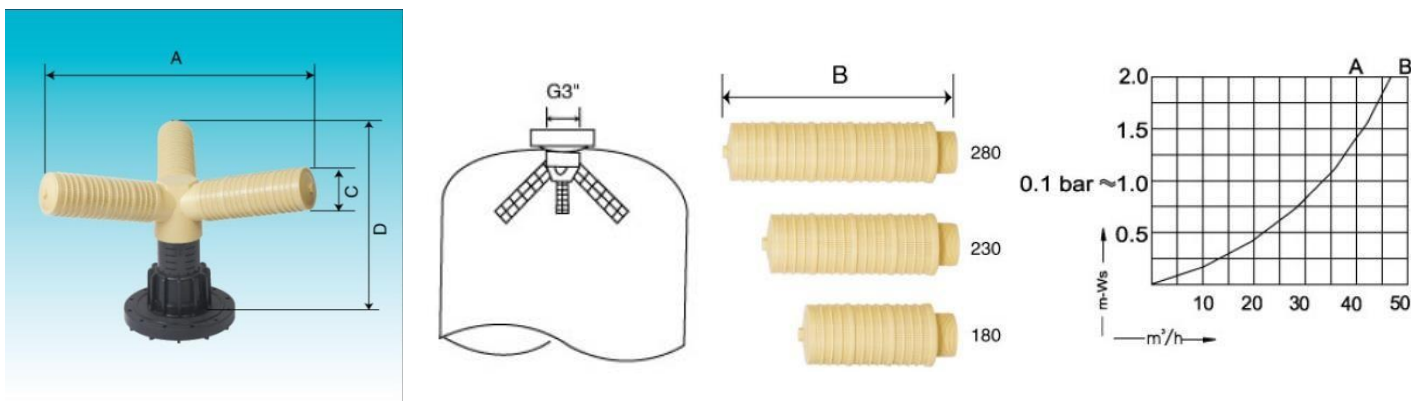

Product Code	Dimensions (mm)				Tanks	Top & Bottom Opening	Slot Size
	A	B	C	D			
HD8180	460	180	85	360	36"-48"/Ø900-1200mm	6" FLG	0.2/0.4mm
HD8230	560	230	85	360	48"-64"/Ø1200-1600mm	6" FLG	0.2/0.4mm
HD8280	660	280	85	360	64"-80"/Ø1600-2000mm	6" FLG	0.2/0.4mm

6" Flanged Top Mount Diffuser for fluidized bed

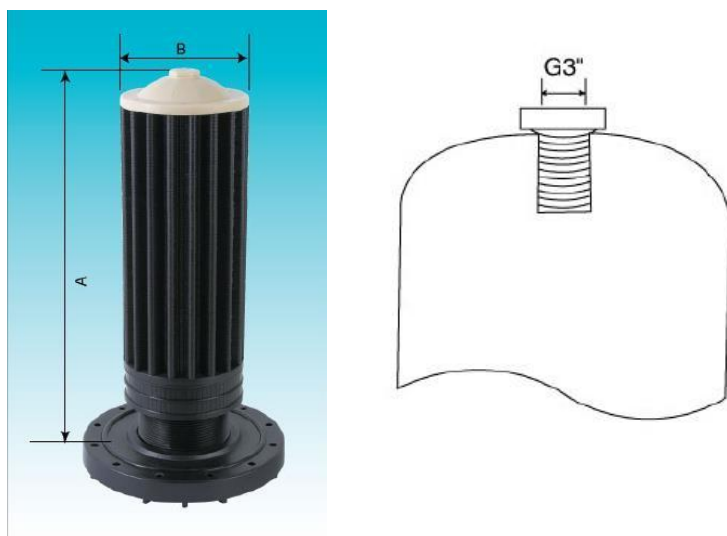

Product Code	Dimensions (mm)		Tanks	Top Opening	Slot Size
	A	B			
HD11250F	350	140	30"-48"/Ø750-1200mm	6" FLG	0.25mm
HD11300F	400	140	40"-60"/Ø1000-1500mm	6" FLG	0.25mm
HD11400F	500	140	48"-80"/Ø1200-2000mm	6" FLG	0.25mm

Bottom Mount Distributor 8 laterals

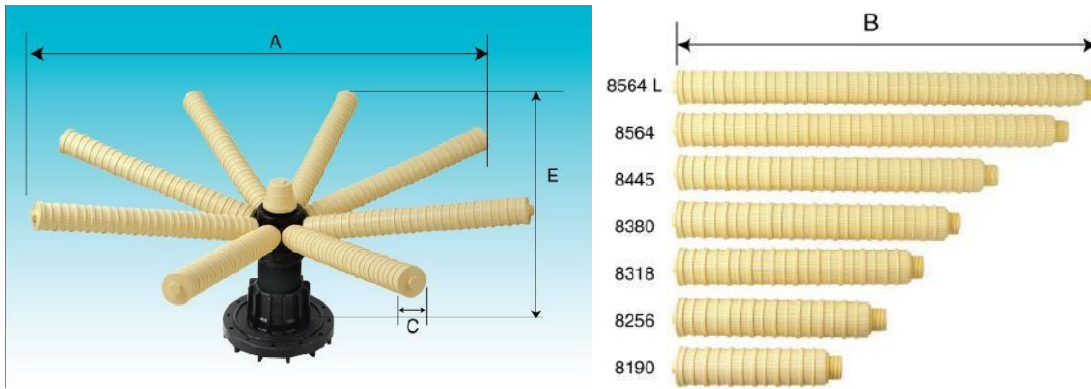

注: IPSI=0.007Mpa, 1GPM=227L/H

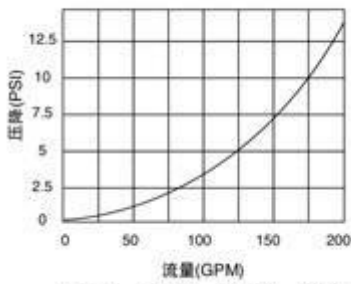

8190-1X 8256-1X 8318-1X 8380-1X

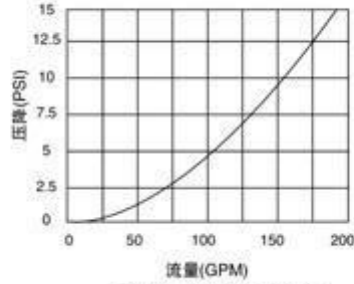

8445-1X 8564-1X 8564-1XL

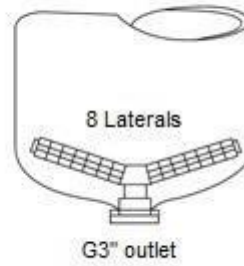

Product Code	Dimensions (mm)			Tanks	Top & Bottom Opening	Slot Size
	A	B	C			
HD8190-1	512	190	53	24"/Ø600mm	6" FLG	0.2/0.25mm
HD8256-1	630	256	53	30"/Ø750mm	6" FLG	0.2/0.25mm
HD8318-1	750	318	53	36"/Ø900mm	6" FLG	0.2/0.25mm
HD8380-1	870	380	53	40"-42"/Ø1000-1050mm	6" FLG	0.2/0.25mm
HD8445-1	980	445	53	48"/Ø1200mm	6" FLG	0.2/0.25mm
HD8564-1	1218	564	53	56-65"/Ø1400-1600mm	6" FLG	0.2/0.25mm
HD8564L-1	1348	640	53	65-80"/Ø1600-2000mm	6" FLG	0.2/0.25mm

Bottom Mount Distributor 16 laterals

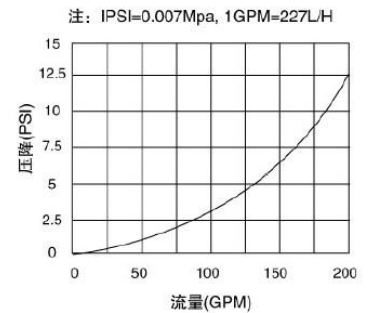
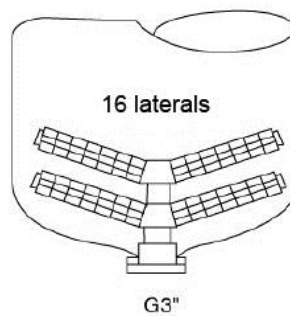
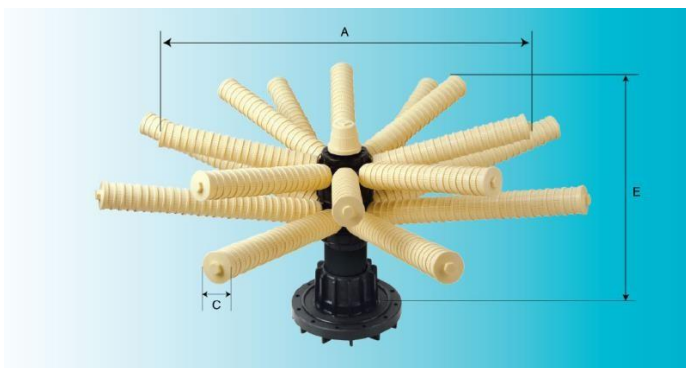

Product Code	Dimensions (mm)			Tanks	Top & Bottom Opening	Slot Size
	A	B	C			
HD8190-2	512	190	53	24"/Ø600mm	6" FLG	0.2/0.25mm
HD8256-2	630	256	53	30"/Ø750mm	6" FLG	0.2/0.25mm
HD8318-2	750	318	53	36"/Ø900mm	6" FLG	0.2/0.25mm
HD8380-2	870	380	53	40"-42"/Ø1000-1050mm	6" FLG	0.2/0.25mm
HD8445-2	980	445	53	48"/Ø1200mm	6" FLG	0.2/0.25mm
HD8564-2	1218	564	53	56-65"/Ø1400-1600mm	6" FLG	0.2/0.25mm
HD8564L-2	1348	640	53	65-80"/Ø1600-2000mm	6" FLG	0.2/0.25mm

Bottom Mount Distributor 8 laterals for filtration

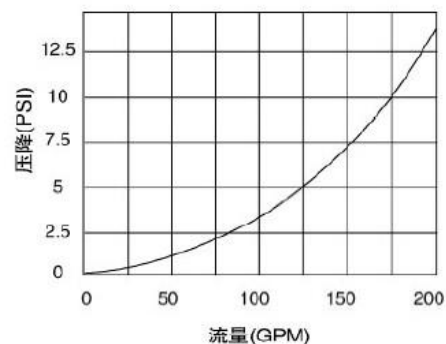
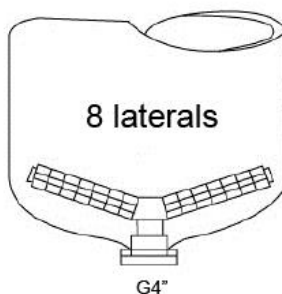
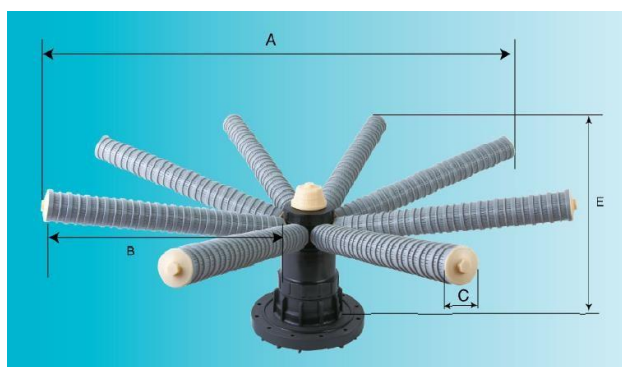

Product Code	Dimensions (mm)			Tanks	Top & Bottom Opening	Slot Size
	A	B	C			
HD8190-1F	512	190	53	24"/Ø600mm	6" FLG	0.5mm
HD8256-1F	630	256	53	30"/Ø750mm	6" FLG	0.5mm
HD8318-1F	750	318	53	36"/Ø900mm	6" FLG	0.5mm
HD8380-1F	870	380	53	40"-42"/Ø1000-1050mm	6" FLG	0.5mm
HD8445-1F	980	445	53	48"/Ø1200mm	6" FLG	0.5mm
HD8564-1F	1218	564	53	56-65"/Ø1400-1600mm	6" FLG	0.5mm
HD8564L-1F	1348	640	53	65-80"/Ø1600-2000mm	6" FLG	0.5mm

Bottom Mount Distributor 16 laterals for filtration

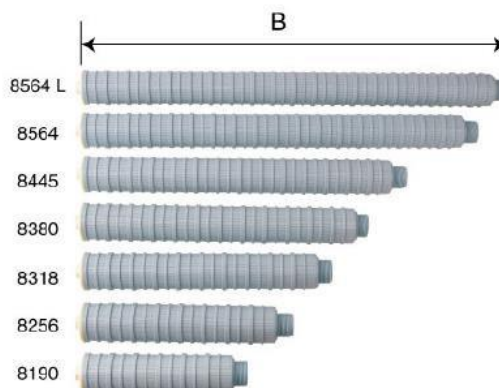
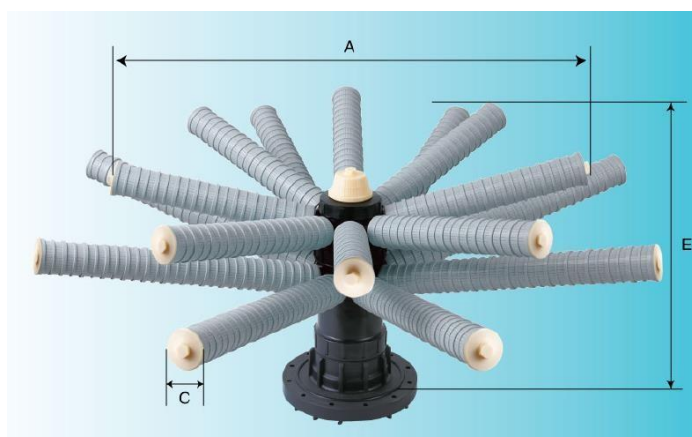

Product Code	Dimensions (mm)			Tanks	Top & Bottom Opening	Slot Size
	A	B	C			
HD8190-2F	512	190	53	24"/Ø600mm	6" FLG	0.2/0.25mm
HD8256-2F	630	256	53	30"/Ø750mm	6" FLG	0.2/0.25mm
HD8318-2F	750	318	53	36"/Ø900mm	6" FLG	0.2/0.25mm
HD8380-2F	870	380	53	40"-42"/Ø1000-1050mm	6" FLG	0.2/0.25mm
HD8445-2F	980	445	53	48"/Ø1200mm	6" FLG	0.2/0.25mm
HD8564-2F	1218	564	53	56-65"/Ø1400-1600mm	6" FLG	0.2/0.25mm
HD8564L-2F	1348	640	53	65-80"/Ø1600-2000mm	6" FLG	0.2/0.25mm

Tank heads

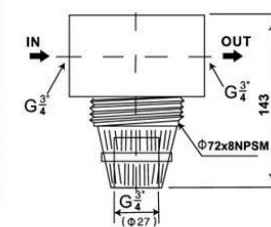
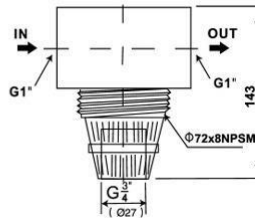
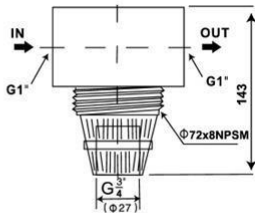

H9901

H9901-103

H9901-104

Product Code	Specification	Tank Opening	Inlet/Outlet	Tanks
H9901	2.5" tank head	2.5"-8NPSM	NPT1"	6"-16"/Ø150-400mm
H9901-103	2.5" tank head	2.5"-8NPSM	NPT1"	6"-16"/Ø150-400mm
H9901-104	2.5" tank head	2.5"-8NPSM	NPT3/4"	6"-12"/Ø150-300mm

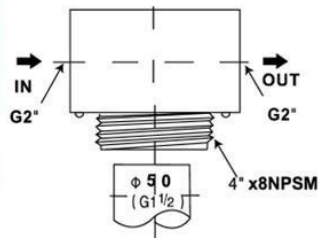

H9902

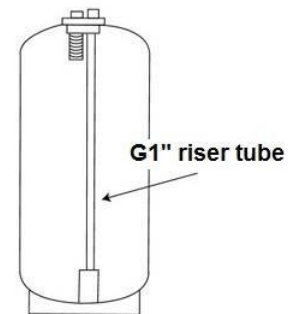

H9902-1

Product Code	Specification	Tank Opening	Inlet/Outlet	Tanks
H9902	4" tank head	4"-8UN	NPT2"	16"-36"/Ø400-900mm
H9902-1	4.5" tank head with distributors	4.5" Buttress	NPT1"	12"-18"/Ø300-450mm

Laterals and Riser Tubes

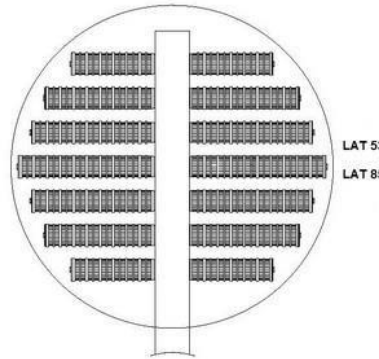
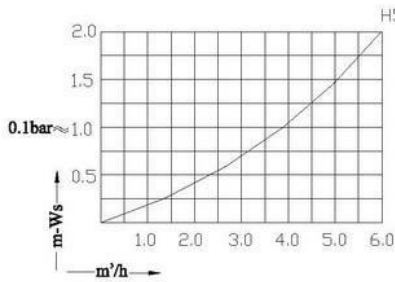
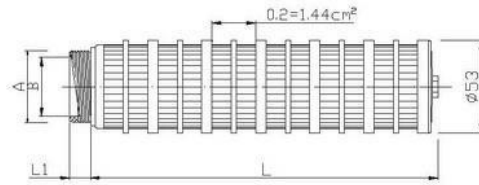

Lateral Ø53: LAT53

Product Code	A Size	B (mm)	L1(mm)	Slot Size	L (mm)	Material
LAT53-034-02-82	NPT3/4"	18.5	17	0.2/0.4mm	82	PP/HPPP
LAT53-034-02-136	NPT3/4"	18.5	17	0.2/0.4mm	136	PP/HPPP
LAT53-034-02-182	NPT3/4"	18.5	17	0.2/0.4mm	182	PP/HPPP
LAT53-034-02-260	NPT3/4"	18.5	17	0.2/0.4mm	260	PP/HPPP
LAT53-034-02-330	NPT3/4"	18.5	17	0.2/0.4mm	330	PP/HPPP
LAT53-034-02-410	NPT3/4"	18.5	17	0.2/0.4mm	410	PP/HPPP

Product Code	A Size	B (mm)	L1(mm)	Slot Size	L (mm)	Material
LAT53-100-02-190	NPT1" /G1"	21	17	0.2/0.4mm	190	PP/HPPP
LAT53-100-02-256	NPT1" /G1"	21	17	0.2/0.4mm	256	PP/HPPP
LAT53-100-02-318	NPT1" /G1"	21	17	0.2/0.4mm	318	PP/HPPP
LAT53-100-02-380	NPT1" /G1"	21	17	0.2/0.4mm	380	PP/HPPP
LAT53-100-02-445	NPT1" /G1"	21	17	0.2/0.4mm	445	PP/HPPP
LAT53-100-02-564	NPT1" /G1"	21	17	0.2/0.4mm	564	PP/HPPP
LAT53-100-02-600	NPT1" /G1"	21	17	0.2/0.4mm	600	PP/HPPP

Product Code	A Size	B (mm)	L1(mm)	Slot Size	L (mm)	Material
LAT53-114-02-190	NPT1-1/4" /G1-1/4"	21	22	0.2/0.4mm	190	PP/HPPP
LAT53-114-02-256	NPT1-1/4" /G1-1/4"	21	22	0.2/0.4mm	256	PP/HPPP
LAT53-114-02-318	NPT1-1/4" /G1-1/4"	21	22	0.2/0.4mm	318	PP/HPPP
LAT53-114-02-380	NPT1-1/4" /G1-1/4"	21	22	0.2/0.4mm	380	PP/HPPP
LAT53-114-02-445	NPT1-1/4" /G1-1/4"	21	22	0.2/0.4mm	445	PP/HPPP
LAT53-114-02-564	NPT1-1/4" /G1-1/4"	21	22	0.2/0.4mm	564	PP/HPPP

Remark: If the slot size is 0.4mm, product code would : LAT53-034-04-82

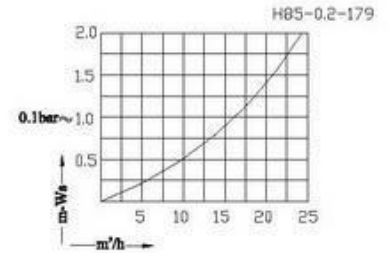
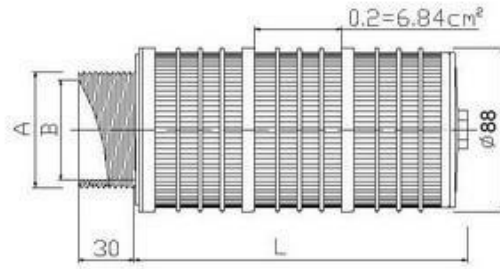

Lateral Ø88: LAT88

Product Code	A Size	B (mm)	L1(mm)	Slot Size	L (mm)	Material
LAT88-200-02-130	NPT2" /PT2" /G2"	50	30	0.2mm	130	PP/HPPP
LAT88-200-02-230	NPT2" /PT2" /G2"	50	30	0.2mm	230	PP/HPPP
LAT88-200-02-280	NPT2" /PT2" /G2"	50	30	0.2mm	280	PP/HPPP
LAT88-200-02-360	NPT2" /PT2" /G2"	50	30	0.2mm	360	PP/HPPP
LAT88-200-02-800	NPT2" /PT2" /G2"	50	30	0.2mm	800	PP/HPPP

Riser Tubes

Product Code	Riser Tube	OD (mm)	ID (mm)	Length (mm)	Tanks
RTB-DN27-80	3/4" riser tube	26.7	N/A	80	TK735,TK835,TK935 TK1035
RTB-DN27-115	3/4" riser tube	26.7	N/A	115	TK844,TK942,TK948,TK1044
RTB-DN27-129	3/4" riser tube	26.7	N/A	129	TK1054,TK1252,TK1354
RTB-DN27-152	3/4" riser tube	26.7	N/A	152	TK1265,TK1465,TK1665,TK1865
RTB-DN50-200	1.5" riser tube	50	40	200	TK2072-TK4872
RTB-DN63-200	2" riser tube	63	50	200	TK2072-TK4872



Adaptors, closures and Flanges



H9903-B

H9904

H9905

H9914

H9913

Product Code	Description	Material	Outer Thread	Inner Thread
H9903-B	4"-2.5" Adaptor	ABS/PPO	4"-8UN	2.5"-8 NPSM
H9904	6"-4" adaptor	ABS/PPO	6"-8UN	4"-8UN
H9905	6"-4" FLG Adaptor	ABS/PPO	/	4"-8UN
H9914	4" Closure	ABS/PPO	4"-8UN	/
H9913	6" FLG Closure	ABS/PPO	/	/



Nozzle

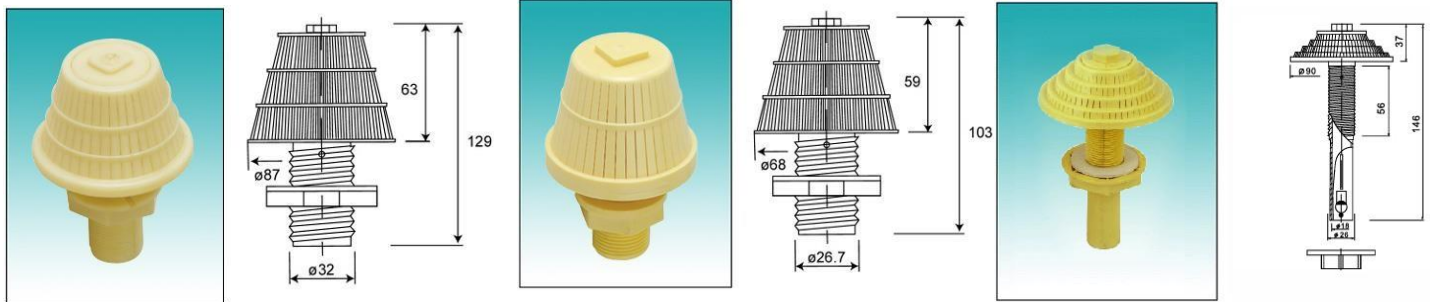

HD201

HD202

MH-HD224

Product Code	Outlet Flow	Backwash flow	Material
HD201	1T/H	0.3-0.6T/H	PP
HD202	0.5T/H	0.3-0.6T/H	ABS
HD224	1T/H	0.3-0.6T/H	PP

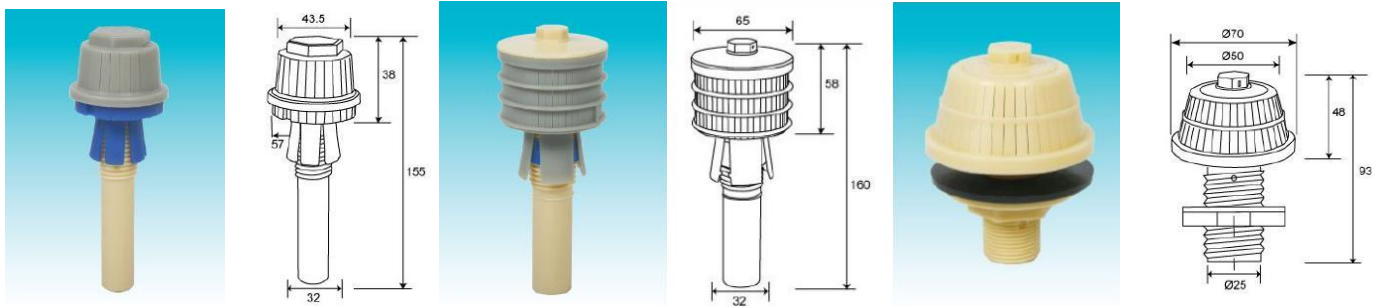

HD227

HD228

HD229

Product Code	Outlet Flow	Backwash flow	Material
HD227	0.3T/H	0.3-0.6T/H	PP
HD228	1T/H	0.3-0.6T/H	PP
HD229	0.5T/H	0.3-0.6T/H	PP