

# **Fingerprint Access Control/ Attendance Time Clock**

User Manual

Rev: 1.02

# Contents

<b>I.</b>	<b>NOTICE FOR USING .....</b>	<b>- 4 -</b>
1.1	OPERATING ENVIRONMENT.....	- 4 -
1.2	INSTALLATION PRECAUTIONS .....	- 4 -
<b>II.</b>	<b>QUICK GUIDE .....</b>	<b>- 6 -</b>
2.1	KEYS .....	- 7 -
2.2	DESCRIPTION OF PRESSING FINGERPRINT .....	- 8 -
2.3	DESCRIPTION OF MENU OPERATION .....	- 9 -
2.3.1	<i>Constitution of the menu</i> .....	- 10 -
2.4	BASIC OPERATION .....	- 10 -
<b>III.</b>	<b>PERSONNEL MANAGEMENT .....</b>	<b>- 13 -</b>
3.1	USER REGISTER .....	- 13 -
3.1.1	<i>Fingerprint register</i> .....	- 14 -
3.1.2	<i>Password register</i> .....	- 17 -
3.1.3	<i>Sensor card No. register</i> .....	- 19 -
3.2	USER VALIDATION .....	- 20 -
3.3	ADMINISTRATOR REGISTER.....	- 23 -
3.3.1	<i>Super administrator</i> .....	- 23 -
3.3.2	<i>Register administrator</i> .....	- 23 -
<b>IV.</b>	<b>ENROLL .....</b>	<b>- 25 -</b>
4.1	DELETE REGISTRATION DATA .....	- 25 -
4.2	DOWNLOAD TO USB-DISK .....	- 26 -
4.3	DELETE ALL RECORDS.....	- 28 -
4.4	CHECK ACCESS RECORDS.....	- 28 -
4.5	SYSTEM INFO .....	- 29 -
<b>V.</b>	<b>SETTINGS .....</b>	<b>- 30 -</b>
5.1	SYSTEM .....	- 30 -
5.2	ACCESS CONTROL .....	- 34 -
5.3	COMMUNICATION .....	- 44 -
5.4	LOG SETUP.....	- 48 -
<b>VI.</b>	<b>ATTENDANCE FUNCTION .....</b>	<b>- 50 -</b>
6.1	THE OPERATION OF ATTENDANCE BUTTONS .....	- 50 -
6.1.1	<i>On duty attendance</i> .....	- 50 -
6.1.2	<i>Off duty attendance</i> .....	- 50 -

6.1.3	<i>Go-out attendance</i> .....	- 51 -
6.1.4	<i>Return attendance</i> .....	- 51 -
6.2	AUTO SWITCHING OF ATTENDANCE MODE.....	- 52 -
<b>VII.</b>	<b>APPENDIX</b> .....	<b>- 53 -</b>
7.1	THE STRUCTURE OF ENROLL MENU.....	- 53 -
7.2	THE STRUCTURE OF SETTINGS MENU .....	- 54 -
7.3	THE STRUCTURE OF SYSTEM INFO MENU .....	- 57 -
<b>VIII.</b>	<b>TROUBLESHOOTING</b> .....	<b>- 58 -</b>

# I. Notice for using

---

Thanks for purchasing our Fingerprint Access Control/Attendance Time Clock. Before using this product, please carefully read this manual, which helps you improve the efficiency of using this product.

## 1.1 Operating environment

- Avoid installing the Fingerprint Access Control/Attendance Time Clock at places where irradiated by strong light directly. The strong light affects the collecting of fingerprints and cause that the fingerprint validation can't pass normally.
- The operating temperature of Fingerprint Access Control/Attendance Time Clock is 0°C–60°C. Avoid using outdoor for too long time. The normal working of the Fingerprint Time Attendance Terminal will be affected if it is used in outdoor for long time; if it is necessary to use outdoor, the sunshade and cooling equipment are recommended in summer and warm keeping facility is recommended in winter to protect the Fingerprint Access Control/Attendance Time Clock.

## 1.2 Installation precautions

- Before installing, please make sure that the power supply is cut off. The contact of power cord may damage the device if the installation and wire connection are performed when the power supply is connected.
- As human body carries too much static electricity in autumn and winter, please connect the earth wire before connecting other wires to avoid damaging the device because of too high instant static voltage.
- The bare parts of all wiring terminals should be no longer than 5mm. It may cause short circuit and damage the device if the bare wire is too long; in addition, to make it easy to recognize, please connect the terminals with cables of different colors.
- Please connect other cables before connecting the power cord, and then connect

the power supply and test the device. If the device can't work normally when the power supply is connected, please cut off the power supply and then check the device.

- If the power supply is too far away from the device, do not use the network cable to replace the power cord. The voltage attenuation caused by long transmission distance should be considered when selecting power cord.
- The warranty doesn't cover the damage of circuit, mainboard and fingerprint collector, and malfunction caused by improper wiring.
- The device should be installed at the height of 1.4-1.5m.
- To test the access control function after installing, there should be people both inside and outside the door to avoid failing to access normally in case of accident.

## II. Quick guide

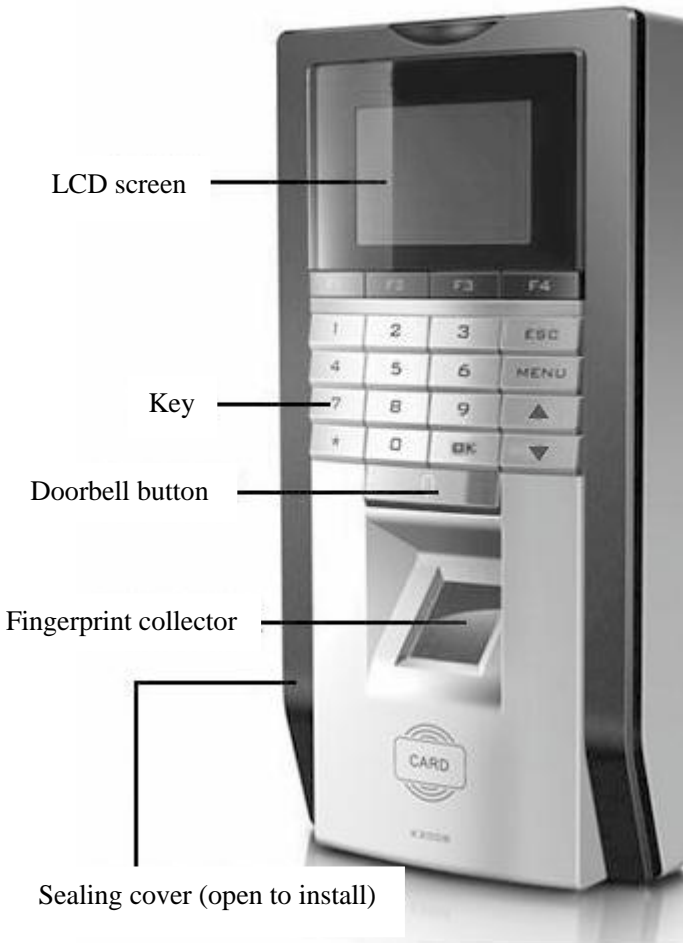

Appearance of the Fingerprint Access Control/Attendance Time Clock (Front)

## 2.1 Keys

The keypad deployment is shown in Fig. 2-1:

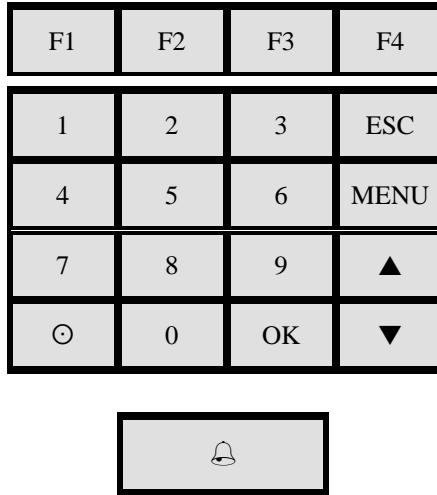

Fig. 2-1

The functions of keys are shown in Fig. 2-2:

- ESC To EXIT or CANCEL when operating the menu
- MENU To access the menu management
- OK To confirm current settings
- Ⓞ Power switch
- ▲ Scroll up while operating
- ▼ Scroll down while operating
- 0...9 To input numbers when operating or selecting menus
- F1 On duty attendance settings
- F2 Off duty attendance settings
- F3 Out attendance settings

Fig. 2-2

## 2.2 Description of pressing fingerprint

Correct pressing method: Press with your finger right on the fingerprint collecting window, with the fingerprint's centre aligning to the centre of the gathering window as much as possible. Finger pressing method is shown as follows:



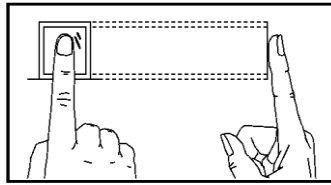

Correct

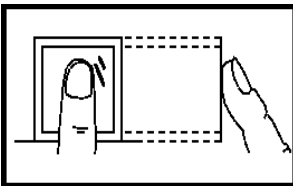

Too perpendicular

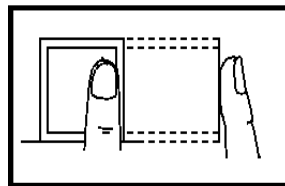

Too deflective

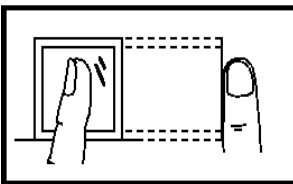

Tilting

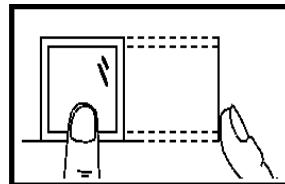

Too low

## 2.3 Description of menu operation





When the device is in standby state, press the [MENU] button to access the main menu. To operate specific items, you can press the function keys and number keys to select menus and input numbers quickly.

### 2.3.1 Constitution of the menu

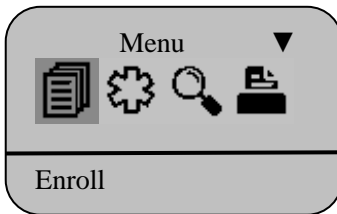
The Menu consists of Enroll, Settings, Check Attendance Records and System Info. Each menu contains second level and third level menus and you can select to perform corresponding operations.

The structure of the Menu is shown in the picture below:



-  Enroll:  
Register and delete the fingerprints, passwords and sensor card data of users or administrators, clear records and download to USB-Disk.
-  Settings:  
Include system settings, access control settings, record settings and communication settings.
-  Check Access Records  
Check the access records and attendance records of the staff.
-  System Info:  
Check the register, management and attendance information in the Fingerprint Access Control/Attendance Time Clock.

## 2.4 Basic operation

- Turning on

After connecting the power cord, press the  key, the LCD displays the main interface and a long beep accompanies.

 **Note:** The power supply for the Fingerprint Access Control/Attendance Time Clock must be DC **12V**.

➤ **Accessing menu**

Press the [MENU] key to access the Menu to manage the data and set the menu.

 **Note:** After registering the administrator, it is necessary to pass the validation to enter the Menu.

➤ **Personnel management**

In the Menu, select [Enroll] and press the [OK] button to access the menu; then, select User or [Manager] to register the fingerprints, sensor card and password.

The administrators include [Sup Manager] and [Gen Manager]. They have different management authorities, which will be explained in Chapter III.

➤ **Function settings**

In the Menu, select [setup] and press the [OK] button to enter the setting menu. The [setup] menu consists of [System], [Lock Settings], [Communication] and [Log Setup].

➤ **Checking access records**

In the Menu, select [Glog View] and press the [OK] button to enter the menu. You can check the attendance time and number of times.

➤ **System information**

In the Menu, select [System Info] and press the [OK] button to enter the submenu. You can check the registration information of the system.

➤ **Access validation**

In case of access validation, the LCD of the device must be in the standby interface, as shown in the picture below:



Perform validation according to preset modes (e.g. fingerprint, password, sensor card No. or combination).

➤ **Attendance registration**

Before attendance registration, press the F1~F4 button on the panel to switch the attendance state. The state displays in the upper left corner of the LCD. After validation, the device says “Thank you!” and the LCD displays “Fingerprint confirmed”, as shown in the picture below:

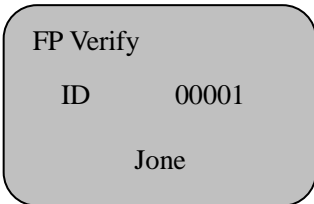

### III. Personnel management

In normal working state, press the [MENU] button to access the Menu directly if no administrator is registered, as shown in the picture below:

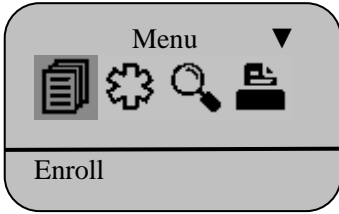

In this interface, press the Scroll down button to view the menus. If [Enroll] is selected, press the [OK] button to access level-2 menu. [Enroll] consists of five level-2 menus, which are User, [Manager], [Delete], [Download] and [AllLog Delete], as shown in the picture below:

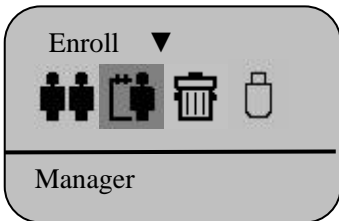
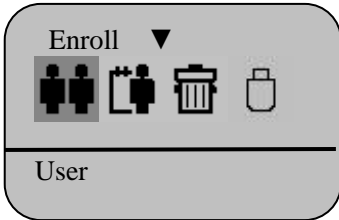

#### 3.1 User Register

Seven modes are available for the validation of the device: fingerprint, password, card

No., card + fingerprint, card + password, fingerprint + password, card + fingerprint + password.

When users register, each person has only one exclusive [Enroll ID], and the number must be corresponding to the Enroll ID in the attendance management software; each [Enroll ID] can register up to three fingerprints, one sensor card No. and one password.

### 3.1.1 Fingerprint register

The normal working interface of the device is shown below:



#### Step of registering fingerprints:

In the normal working state, press the [MENU] button to access [Menu] -> [Enroll] -> User -> [Finger] -> [New Enroll] -> Input Enroll ID -> Press same finger for three times -> Save -> Exit.

Refer to the following pictures for the details of the operation:

Press the [MENU] button to display the [Menu] as follow:

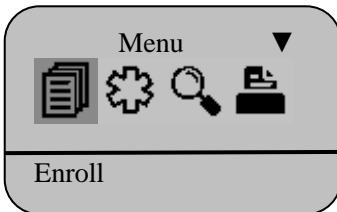

Select [Enroll] and press the [OK] button to display the following picture:

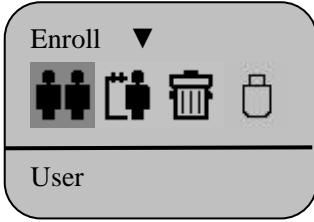

Select User and press the [OK] button to display the following picture:

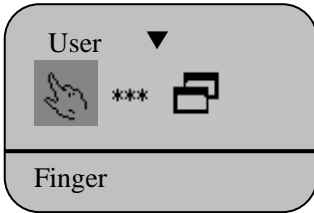

Select [Finger] and press the [OK] button to display the following picture:

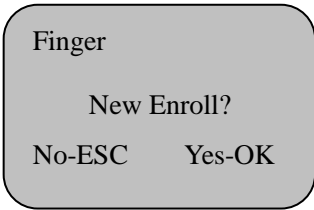

Press the [OK] button to access [New registration] as follow:

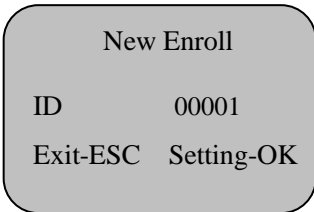

Note: the range of Enroll ID is 1-65535.  
For the first registration, the Enroll ID is 00001 by default.

Press the number keys to enter Enroll ID and then press the [OK] button to display the following picture:



Press the fingerprint collector with a finger in correct method and move the finger away, and then follow the prompt to press the same finger for the second and third times; if the registration is successful, it displays the following picture:

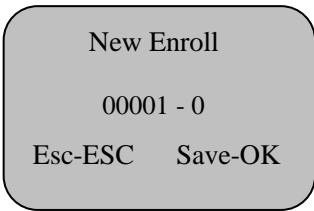

Note: 00001 - 0  
The last figure 0 indicates the first fingerprint.

Press the [OK] button to save and the following picture displays if the registration is successful:

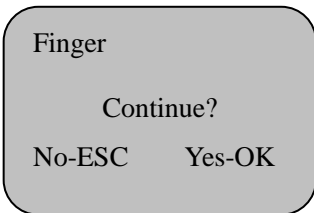

To continue registering fingerprints, press the [OK] button:

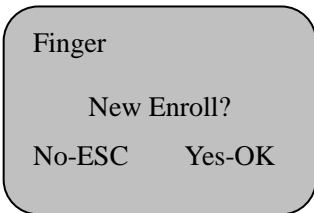

Press the [OK] button to register new fingerprint information and repeat the above steps. To backup another fingerprint for a registered user, press the ESC button to display the following picture:



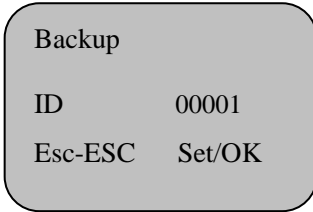

Select Enroll ID, and press the [OK] button to confirm registering the backup fingerprint (you can backup two fingerprints with the device).

 **Note:**

If the device supports access control, the third fingerprint that user registers is defaulted as the duress alarm fingerprint.

### 3.1.2 Password register

Press the [MENU] button to access the Menu -> [Enroll] -> User and the following picture displays:

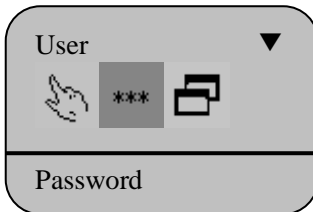

Select [Password] and press the [OK] button:

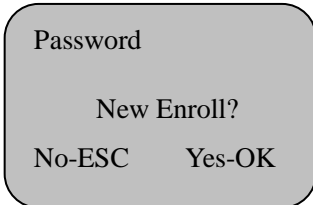

Press the [OK] button again to confirm and set password for the new Enroll ID, as shown below:

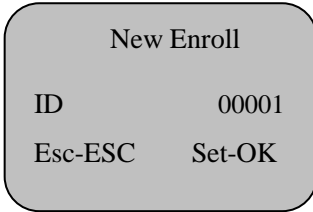

Input the Enroll ID of certain personnel and press the [OK] button:

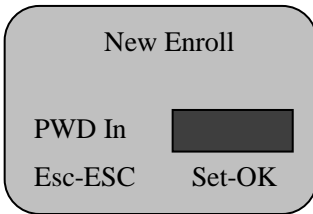

Note: The password contains up to four digits.

Input the password and press the [OK] button to display the following picture:

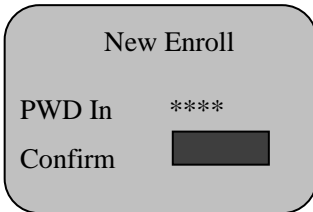

Repeat the password and press the [OK] button; if the two passwords are the same, the following picture displays:

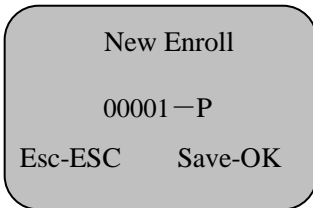

Note: 1) 00001 - P, P indicates that password is registered.

2) If the passwords are different, it asks you to re-input.

Press the [OK] button to save and the password is registered successfully.

### 3.1.3 Sensor card No. register

Press the [MENU] button to access the Menu → [Enroll] → User, and the following picture displays:

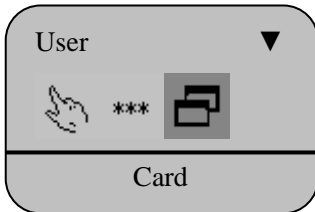

Select [Card] and press the [OK] button:

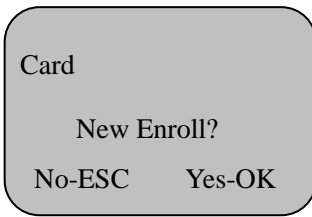

Press the [OK] button to register new card number:

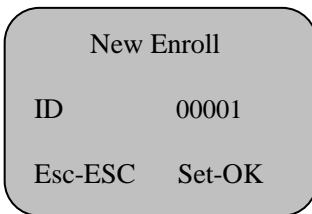

Input the Enroll ID of certain personnel and press the [OK] button:

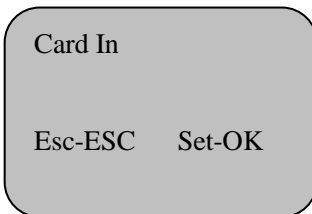

Put the sensor card in the sensing area and the following picture displays if the card is sensed:

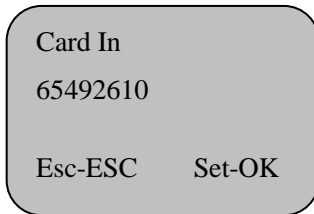

Press the [OK] button to complete the registration and press the ESC button to exit.



**Tip:**

- If the device doesn't have administrator, any person can edit the settings of the terminal. If any administrator has been registered, the edit and settings of the terminal must be approved by the administrator. The administrators are divided into [Sup Manager] and [Gen Manager]; the [Sup Manager] has the top management authority of the terminal and is able to set all functions of the terminal; the [Gen Manager] can only set three functions: User, [Delete] and [AllLog Delete].
- When users input Enroll IDs to check registration, you can just input the nonzero and later figures. For example, if the Enroll ID is 00050, you can just input "50".

## 3.2 User validation

- The user validation generally refers to sign in/out (make sure that the fingerprint has been registered in the device). Press in correct method to validate (see Chapter 2.2).

**Fingerprint validation:**

- User 1: N fingerprint validation: press the fingerprint directly on the fingerprint collector and the terminal prompts "Thank you" if the validation is successful, as follow:

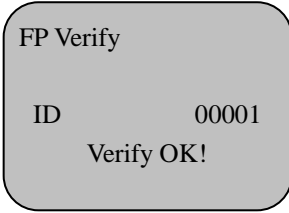

- User 1:1 fingerprint validation: input your Enroll ID with the keypad and then press the finger, and the terminal prompts “Thank you” if the validation is successful, as follow:

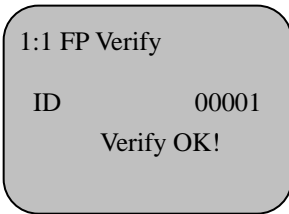

If the fingerprint validation fails, the terminal prompts “Please re-press your finger”, as follow:

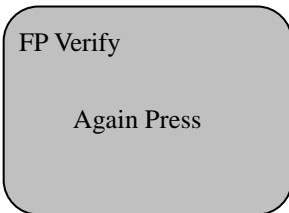

**Password validation:**

The user inputs the Enroll ID with the keypad, presses the [OK] button and inputs the password to display the following picture:

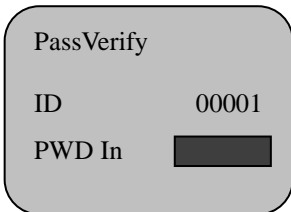

If the password validation is successful, the device displays “Confirmed!” and prompts “Thank you!”

If the password validation fails, the terminal beeps and displays “Please re-input” as follow:

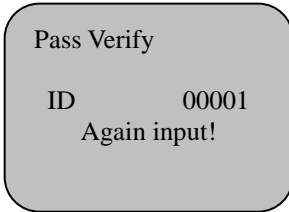

**Sensor card validation:**

Put the ID sensor card in the sensing area and the device displays “Confirmed!” if the sensor card validation is successful and prompts “Thank you”.

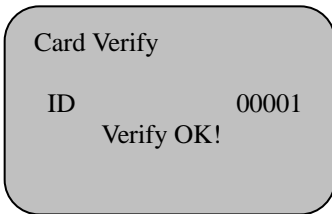

If the validation fails, the device beeps and displays “Please re-input”.

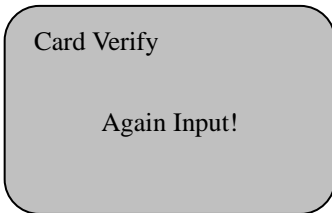

## 3.3 Administrator register

### 3.3.1 Super administrator

Press the [MENU] button to access [Menu] -> [Enroll] -> [Manager], and press the [OK] button to access level-3 menu as follow:

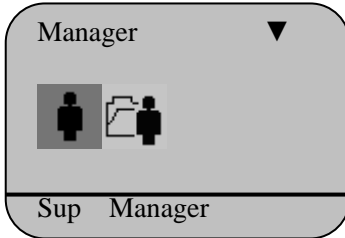

Select [Sup Manager] and press the [OK] button to access level-4 menu, and then you can select the validation mode of super administrator. The menu displays as follow:

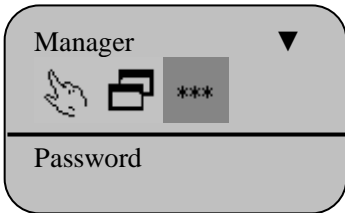

See Chapter 3.1.1/3.1.2/3.1.3 for specific operating steps.

### 3.3.2 Register administrator

Select the [Gen Manager] menu and press the [OK] button to access level-4 menu, and then you can select the validation mode of register administrator. The contents and operating method of the menu are same to super administrator; the [Gen Manager] only has three authorities: [Personnel register], [Delete registration] and [Clear records].

#### **Note:**

If administrator has been registered, the identity validation of the administrator is needed to access the Menu, as follow:

Manager?

16:11

08/03/26    Wed

If the identity validation of the administrator fails (fingerprint is invalid, password is invalid or sensor card is incorrect), the terminal displays “Illegal operation!” and gives alert tone. You need to re-confirm the identity of the administrator; if the validation is successful, you can access the management menu interface.



**Tip:**

- For administrators registered with fingerprints, press the [MENU] button and then press the finger that the fingerprint is registered on the fingerprint collecting window; the menu interface displays if the validation is successful;
- For administrators registered with password, press the [MENU] button to input the registered number, press the [OK] button to enter the password, and then press the [OK] button; the menu interface displays if the validation is successful;
- For administrators registered with sensor card, press the [MENU] button and put the registered sensor card in the sensing area; the menu interface displays if the validation is successful.



## IV. Enroll

In normal operating state, press the [MENU] button to access the Menu and select [Enroll], as shown below:

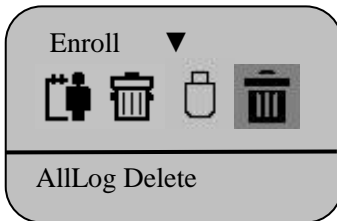
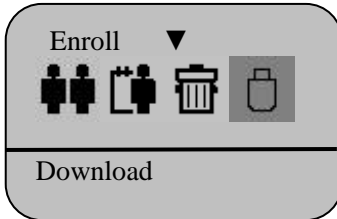
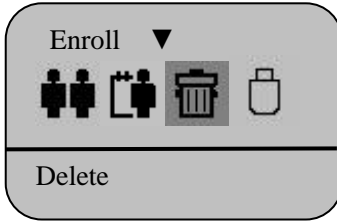

### 4.1 Delete registration data

Press the [MENU] button to access [Menu] → [Enroll] → [Delete] and press the [OK] button to display the following picture:

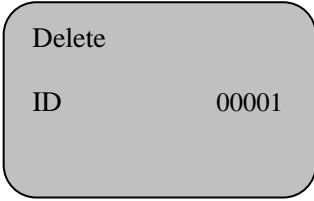

Input the Enroll ID to be deleted (e.g. 00001), and press the [OK] button to display the following interface:

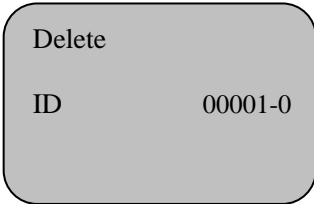

Note: the last figure of 00001-0 indicates the number of the fingerprint (0 indicates the first fingerprint)

Press the [OK] button to confirm and the following interface displays:

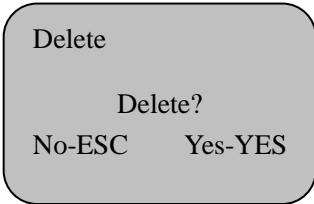

Press the [OK] button to delete and the “Delete?” interface pops up after a beep; you can press the [ESC] button to cancel deleting.

## 4.2 Download to USB-Disk

- Insert compatible USB-Disk into the USB interface of the terminal;
- In Enroll > Download, press the [OK] button to have the following interface:

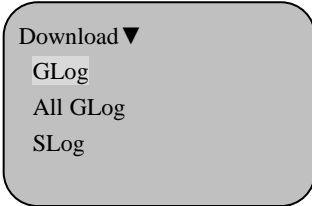

Note: The data are saved in the terminal circularly. Even if new records are downloaded, the old records are still saved in the terminal, until 50000 records are saved.

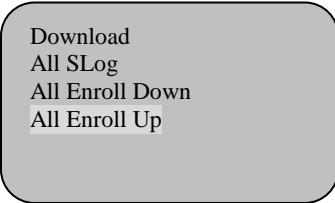

Select [GLog] and press the [OK] button to display the following picture:

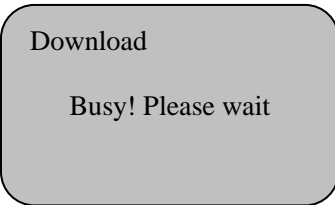

- Select [**GLog**] and press the [OK] button to download new access records to the USB-Disk; if there is no new record after downloading, it prompts that download fails when you download next time;
- Select [**All GLog**] and press the [OK] button to download all access records and attendance records to the USB-Disk;
- Select [**SLog**] and press the [OK] button to download new management records to the USB-Disk;
- Select [**All SLog**] and press the [OK] button to download all management records to the USB-Disk;
- Select [**All Enroll Down**] and press the [OK] button to download all fingerprint registration data to the USB-Disk;
- Select [**All Enroll Up**] and press the [OK] button to upload all fingerprint registration data saved in the USB-Disk to the device.

 **Note:**

- To display the names while validating personnel, you can connect the device to PC, acquire all registration with software and then write all names of the personnel into the device.
- The [SLog] operation will mark the corresponding records as downloaded. To download same records, you need to select [SLog]. The downloading of management records is similar.

### 4.3 Delete all records

Press the [MENU] button to access → [Enroll], select [AllLog Delete] and press the [OK] button to display the following picture:

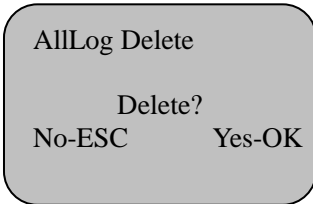

Press the [OK] button to delete all the access records saved in the device, or press the [ESC] button to cancel and exit.

### 4.4 Check access records

In the Menu, select [Glog View] and press the [OK] button to display the following picture:

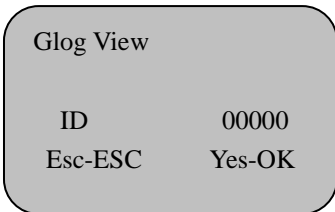

Input the Enroll ID with number keys and press the [OK] button to check the records

of the number.

## 4.5 System info

In the Menu, select [System Info] and press the [OK] button to access level-2 menu. You can press the Up/Down button to select among seven submenus (select a menu and press the [OK] button to display the submenus), as shown below:

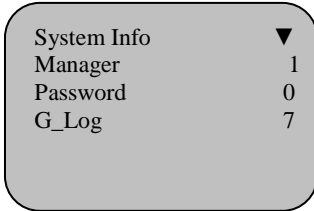
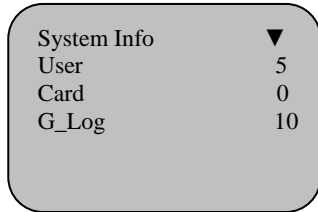
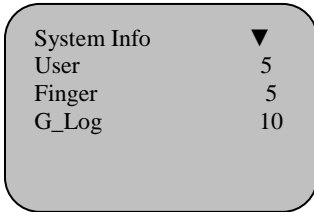

[System Info] consists of User, [Manager], [Finger], [Card], [Password], [G\_LOG] and [S\_LOG]; you can press the [OK] button to switch to desired items.

- User: Check the total number of user registrations.
- [Manager]: Check the total number of registered administrators.
- [Finger]: Check the total number of registered fingerprints.
- [Card]: Check the total number of registered sensor card numbers.
- [Password]: Check the total number of registered passwords.
- [G\_LOG]: Check the total number of access records.
- [S\_LOG]: Check the total number of management records.

## V. Settings

In normal working state, press the [MENU] button to access and select the [setup] menu, and then press the [OK] button to access level-2 menu, as follow:

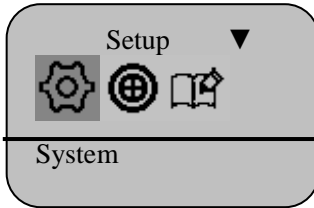

The Settings menu consists of four submenus: System Access Control, Communication and Records.

### 5.1 System

In System menu, press the [OK] button to display the following picture:

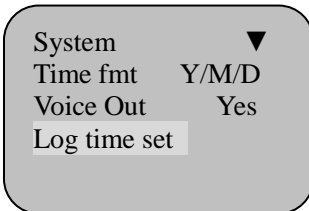
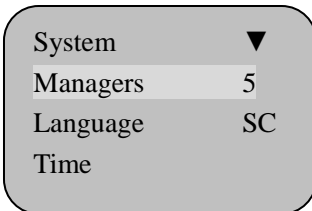

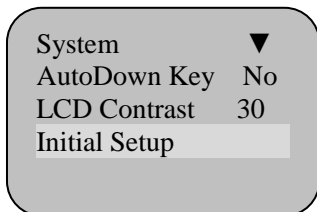
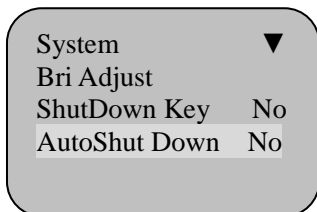

The System menu consists of 11 level-3 menus: [Total administrators], [Language], [Time], [Time fmt], [Voice out], [Log TimeSet], [Lock Ctrl], [Shut Down Key], [Auto Shut Down], [LCD Contrast] and [initial setup].

## 1) Managers

Content	Description
1-10	Set the total number of administrators of the device
Default	5

## 2) Language

Content	Description
Simplified Chinese	The characters are displayed in simplified Chinese
Traditional Chinese	The characters are displayed in traditional Chinese
English	The characters are displayed in English
Korean	The characters are displayed in Korean

Default	Simplified Chinese
---------	--------------------

### 3) Time

Content	Description
Time setting	Press the [OK] button to select desired item, and press the scroll up/down button or use the number keys to input the figures and set the time of the device.
Default	The time of the terminal is same as the time of the PC installed with the fingerprint attendance management software, therefore you can set the time with the software.

### 4) Time fmt

Content	Description
Year/Month/Day	Display the time in the sequence of Year/Month/Day
Month/Day/Year	Display the time in the sequence of Month/Day/Year
Default	Year/Month/Day

### 5) Voice out

Content	Description
Yes	Voice alert (“Thank you” or “Please re-press finger”) in case of validation
No	No voice alert. If the validation passes, it gives “Tick-tick-tick” tone. If the validation doesn’t pass, it gives only one “Tick” tone.
Default	Yes



## 6) Bri Adjust

Select the [Bri Adjust] menu and press the [OK] button; the auto matching of brightness of the fingerprint collector is activated if the device ticks twice, and the software selects most appropriate brightness for the collector; the adjustment fails if the device ticks once. After adjusting the sensitivity of the fingerprint sensor, the following picture displays:

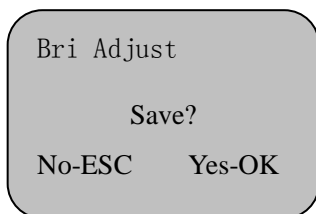

## 7) Shut Down Key

Content	Description
Yes	After confirmation, you can set the schedule off function
No	After confirmation, the schedule off function is invalid
Default	No

## 8) AutoShutdown

This menu is invalid if “No” is selected in the [Shut Down key] menu; you can set the following items if it is activated:

Content	Description
1-255	If the schedule off time (unit: minute) has been set and there is no operation on the terminal, the device switches off automatically.
Default	No

## 9) LCD Contrast

Select the [LCD Contrast] menu and press the [Scroll up]/[Scroll down] button to increase or reduce the contrast of LCD backlight. The range of the LCD backlight contrast is 0 to 63.



### Tip:

If the contrast value is too low, the characters may be blurry. Please cautiously use the value of 0-20 and 40-63. If the value is too low, you can reset in the attendance management software.

## 10) Initial setup

Reset all settings to default and all customized settings will be cleared.

## 5.2 Access control

Select submenu [Lock Setting] in [setup] and press the OK button to display the following picture:

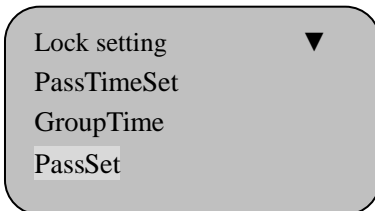
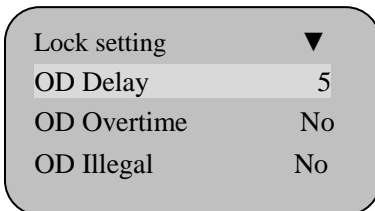

Lock Setting ▼  
 UserPassTime  
 VerifyKind  
 ThreatAct No

Lock Setting ▼  
 ThreatWarn  
 Singnal In No  
 User Data No

Lock Setting ▼  
 Singnal In In  
 No  
 User Data No  
 Wg format 26

**1) OD delay**

Content	Description
1-255	The device sends a close signal to the controller when the open time reaches specified value (unit: second).
No	The device sends a close signal immediately after sending the open signal.
Default	5

**2) OD OverTime alarm**

Content	Description
---------	-------------

1-3600	Check the state of the magnetic door detector in specified time (Unit: second). If the magnetic door detector and the switch are not in the same state, the device sends alarm signal.
No	The device doesn't send alarm signal no matter the open time is long or not.
Default	No

### 3) OD Illegal

Content	Description
1-255	Check the open state in specified time (Unit: second). The device sends alarm signal if the door is open when no open signal is sent.
No	The device doesn't send alarm signal if the device is opened illegally.
Default	No

### 4) PassTime Set

According to the access rule and system of users, the pass time is divided into 32 time periods (0-31), as shown below:

PassTimeSet ▼

- 0. 00:00-23:59
- 1. 00:00-00:00
- 2. 00:00-00:00

PassTimeSet ▼

- 29. 00:00-00:00
- 30. 00:00-00:00
- 31. 00:00-00:00

**Note:**

The Time period 0 and Time period 31 can't be modified. Time period 0 is 00:00-23:59, indicating that the normal access is allowed all-day; Time period 31 is 00:00-00:00, indicating that the normal access is forbidden all-day.

Time period 0	00:00-23:59	Time period 1	00:00-5:59
Time period 2	6:00-9:00	Time period 3	9:00-11:00
Time period 4	11:00-14:00	Time period 5	14:00-17:00
Time period 6	17:00-19:00	Time period 7	19:00-23:59
...	...	...	...
Time period 30	00:00-00:00	Time period 31	00:00-00:00

### 5) GroupTime

The device contains 32 time groups (0-31) and each time group can select 10 time periods, as shown below:

GroupTime ▼

Group ID 0

Group ID 1

Group ID 2

GroupTime ▼

GroupID 29

Time group 30

Time group 31

Select a time group among 1-30 and press the [OK] button to set 10 time periods for the selected time group, as shown below:

GroupTime	Time
1.	1
2.	2
3.	3

GroupTime	Time
8.	29
9.	30
10.	31

 **Note:**

In the time group, press the [OK] button to set different time periods. Among the 32 time groups, the Time group 0 and Time group 31 can't be modified. The 10 time periods of Time group 0 are all Time period 0, indicating that the normal access is allowed all-day; the 10 time periods of Time period 31 are all Time period 31, indicating that the normal access is forbidden all-day.

	1	2	3	4	5	6	...
0	Time period 0	Time period 0	Time period 0	Time period 0	Time period 0	Time period 0	...
1	Time period 1	Time period 2	Time period 6	Time period 7	Time period 31	Time period 31	...
2	Time period 2	Time period 4	Time period 6	Time period 31	Time period 31	Time period 31	...
3	Time period 2	Time period 3	Time period 4	Time period 5	Time period 6	Time period 31	...
...							

31	Time period 31	Time period 31	Time period 31	Time period 31	Time period 31	Time period 31	...
----	-------------------	-------------------	-------------------	-------------------	-------------------	-------------------	-----

## 6) PassSet

The device contains 32 time zones (0-31) and each time zone corresponds to a day from Monday to Sunday. A time group can be set according to the access control every day, as shown below:

PassSet	▼
Pass ID	0
Pass ID	1
Pass ID	2

PassSet	▼
Pass ID	29
Pass ID	30
Pass ID	31

Select a time zone among 1-30 and press the [OK] button to set the time group of selected time zone, as shown below:

PassSet	Group ID
Sun	31
Mon	2
Tue	2

PassSet	Group ID
Thu	2
Fri	2
Sat	31

 **Note:**

Among the 32 time zones, the Time zone 0 and Time zone 31 can't be modified. The 7 days of Time zone 0 are all Time group 0, indicating that the normal access is allowed all the week; the 7 days of Time zone 31 are all Time group 31, indicating that the normal access is forbidden all the week.

	Sunday	Monday	Tuesday	Wednesday	Thursday	Friday	Saturday
Time zone 0	Time group 0	Time group 0	Time group 0	Time group 0	Time group 0	Time group 0	Time group 0
Time zone 1	Time group 1	Time group 1	Time group 1	Time group 1	Time group 1	Time group 1	Time group 1
Time zone 2	Time group 31	Time group 2	Time group 2	Time group 2	Time group 2	Time group 2	Time group 31
Time zone 3	Time group 3	Time group 3	Time group 3	Time group 3	Time group 3	Time group 3	Time group 3
...							
Time zone 31	Time group 31	Time group 31	Time group 31	Time group 31	Time group 31	Time group 31	Time group 31

## 7) User PassTime

Set the time zone according to the access condition of the personnel. After setting, the user can only access normally in specified time zone, as shown below:

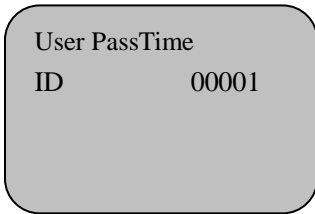

Press the [OK] button to set the time zone of the Enroll ID, as shown below:



UserPassTime	
ID	00001
Pass ID	00
No-ESC	Yes-OK

**For example:**

A indicates that the duty is in the night all the week, and the access is forbidden in the day;

B indicates that the duty is in daytime normally, access is allowed at on/off duty attendance time, and Saturday and Sunday are holidays;

C indicates that the duty is in the daytime all the week, and the access is forbidden in the night.

	Time zone	Access time
A	1	00:00-9:00; 17:00-23:59
B	2	6:00-9:00; 11:00-14:00; 17:00-19:00
C	3	6:00-19:00

**8) Verify Kind**

The recognition mode is the validation mode of access or attendance. Five modes are available and you can only select one of them (default: [Card – Fingerprint - Password]), as shown below:

Verify Kind	▼
Card-FP-PWD	Yes
FP + PWD	No
Card + FP	No

Verify Kind ▼	
Card + FP	No
Card + PWD	No
Card + FP + PWD	

- [Card-Finger-Password] mode: you just need to register fingerprint, or sensor card, or password to pass the validation.
- [Finger + Password] mode: you need to register fingerprint and password and pass both the fingerprint validation and the password validation.
- [Card + Finger] mode: you need to register sensor card and fingerprint and pass both the sensor card validation and the fingerprint validation.
- [Card + Password] mode: you need to register sensor card and password and pass both the sensor card validation and the password validation.
- [Card + Finger + Password] mode: you need to register sensor card, fingerprint and password and pass the sensor card validation, the fingerprint validation and the password validation at the same time.

**9) Duress action**

Content	Description
Yes	The second backup fingerprint of every Enroll ID is duress fingerprint by default and the duress action is activated when you press this fingerprint.
No	The device won't send duress signal when you press this fingerprint.
Default	No

**10) Threat Warn**

If [Yes] is selected in Duress action, the duress alarm is activated, as shown below:

Threat Warn	▼
Open	No
Warn	No
Open + Warn	Yes

Content	Description
Open	When duress action occurs, the device only sends an open signal to the controller and the door is unlocked.
Alarm	When duress action occurs, the device sends an alarm signal.
Open + alarm	When duress action occurs, the device sends open signal and alarm signal, and opens the door and alarms.
Default	Open + alarm

### 11) Signal In

Content	Description
No	When duress action occurs, the device doesn't send alarm signal.
1	When duress action occurs, the device sends alarm0 signal and the alarm0 device responds.
2	When duress action occurs, the device sends alarm1 signal and the alarm1 device responds.
Default	No

### 12) User Data

Content	Description
---------	-------------

Yes	The fingerprint, password or sensor that you have registered is valid only in specified time range. The registration can't pass the validation if it is beyond the range. You can set the validity in the software.
No	The user validity setting is invalid.
Default	No

### 13) WG format

Content	Description
26	WG-26 format external reader
34	WG-34 format external reader
Default	26

## 5.3 Communication

In the [Communication] menu, press the [OK] button to access level-3 menu, as shown below:

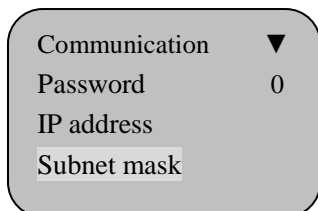
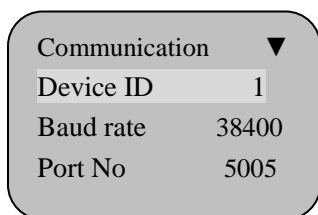

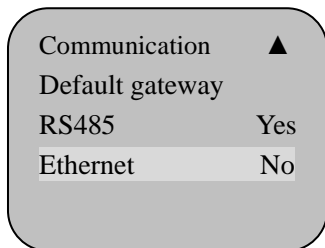

The [Communication] menu consists of nine level-3 menus: [Device No.], [Baud rate], [Port number], [Password], [IP address], [Subnet mask], [Default gateway], [RS485 communication] and [Ethernet].

### 1) Device ID

Content	Description
1-255	Set the ID number of the device. The number can't repeat if more than one device is connected to the PC.
Default	1



#### Note:

Device No. is the unique identity of the terminal. If several terminals in same network have the same device number, they can't work normally and will cause confusion when the fingerprint attendance management software collects the attendance data. Therefore, please pay attention to the uniqueness of the device number if several terminals are in same network.

### 2) Baud rate

Content	Description
9600	Set the baud rate to 9600bps
19200	Set the baud rate to 19200bps
38400	Set the baud rate to 38400bps
57600	Set the baud rate to 57600bps
115200	Set the baud rate to 115200bps

Default	19200
---------	-------

 **Note:**

This value is valid only when RS485 is selected and the value must be same as the port in the PC, otherwise, they can't communicate.

**3) Port No**

Content	Description
1-9999	Set the TCP/IP port of the device
Default	5005

 **Note:**

This port must be same to the port number of the software in the PC, otherwise, they can't communicate.

**4) Password**

Content	Description
0-999999	Set the password of TCP/IP communication
Default	No

**5) IP address**

Content	Description
192.168.1.224	Set the IP address (fixed idle IP) of the device for TCP/IP communication
Default	192.168.1.224

 **Note:**

The IP address in LAN must be exclusive.

**6) Subnet mask**

Content	Description
255.255.255.0	Set the subnet mask of LAN for TCP/IP communication
Default	255.255.255.0

## 7) Default gateway

Content	Description
192.168.1.1	Set the default gateway of the LAN for TCP/IP communication
Default	192.168.1.1

### Note:

The subnet mask and default gateway must be same to the subnet mask and default gateway of the LAN.

## 8) RS485

- To make the device communicates with PC through RS485, you need to select “Yes” for RS485 Communication, as shown below:

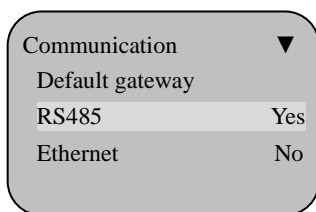

Note: The device number, baud rate and serial port must be consistent with the settings in management station. In addition, the RS485 data converter isn't included in the standard

- See Installation Manual for the wiring mode.

### Note:

RS485 communication (default: No) is the switch of the RS485 communication function of the device.

## 9) Ethernet

- In Communication menu, press the Scroll down button to select “Yes” for Ethernet, as shown below:

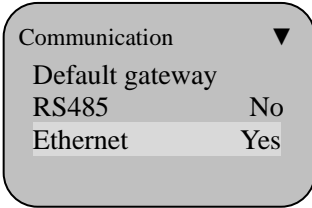

- Set the IP address, subnet mask and default gateway according to the LAN, as shown below:

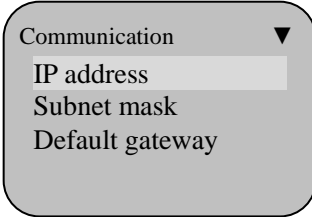

Note: The IP address for TCP/IP communication must be exclusive. The password must be same to the management system.

- Connect the network cable of the LAN to the RJ45 interface of the device.

 **Note:**

TCP/IP communication (default: Yes) is the switch of the TCP/IP communication function of the device.

## 5.4 Log Setup

Select the [Log Setup] menu and press the [OK] button to access level-3 menu, as shown below:

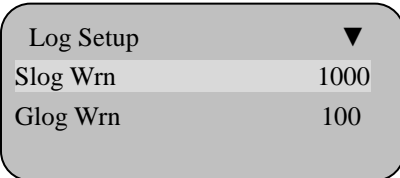

The [Log Setup] menu consists of [Slog Wrn] and [GLog Wrn].



## 1) Slog Wrn

Content	Description
No	When the access records are full, the attendance terminal doesn't alarm and overwrites the attendance records that have been read.
1-1500	The terminal alarms when the free capacity reaches the preset value. If the access records are full, the terminal overwrites the attendance records that have been read.
Default	1000

### Note:

Please download the records in time when the terminal notifies that the access records memory is full in display and alert tone.

## 2) GLog Wrn

Content	Description
No	When the management records are full, the attendance terminal doesn't alarm and overwrites the old management records.
1-255	The terminal alarms when the free capacity reaches the preset value. If the management records are full, the terminal overwrites the earliest management records.
Default	100

### Note:

Please download the management records in time when the terminal notifies that the management records memory is full in display and alert tone.

## VI. Attendance function

---

### 6.1 The operation of attendance buttons

#### 6.1.1 On duty attendance

In standby state, press the [F1] button to access on duty attendance and record the time of on duty attendance, as shown below:



#### 6.1.2 Off duty attendance

In standby state, press the [F2] button to access off duty attendance and record the time of off duty attendance, as shown below:

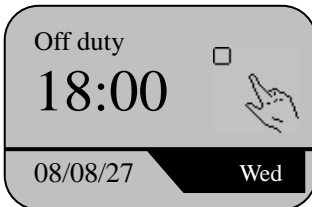

### 6.1.3 Go-out attendance

In standby state, press the [F3] button to access out attendance and record the out time, as shown below:



### 6.1.4 Return attendance

In standby state, press the [F4] button to access return attendance and record the return time, as shown below:

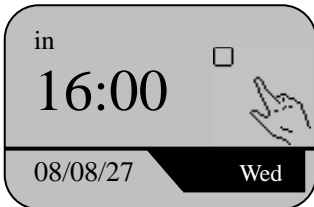

 **Note:**

It is necessary to use the attendance function key before checking attendance with the device. Select an attendance mode and check the attendance when the mode displays in the upper left corner of the screen. The Enroll ID of attendance is same to the Enroll ID of access control; therefore, you can use same fingerprint, sensor card or password to access and check attendance.

## 6.2 Auto switching of attendance mode

In normal operating state, press the [MENU] button to access the [setup] menu and select [time setting] in [System]:

Content	Description
On duty	Set the switching time of attendance state, and it can switch to on duty state automatically
Off duty	Set the switching time of attendance state, and it can switch to off duty state automatically
Go out	Set the switching time of attendance state, and it can switch to go out state automatically
Return	Set the switching time of attendance state, and it can switch to return state automatically

## VII. Appendix

### 7.1 The structure of Enroll menu

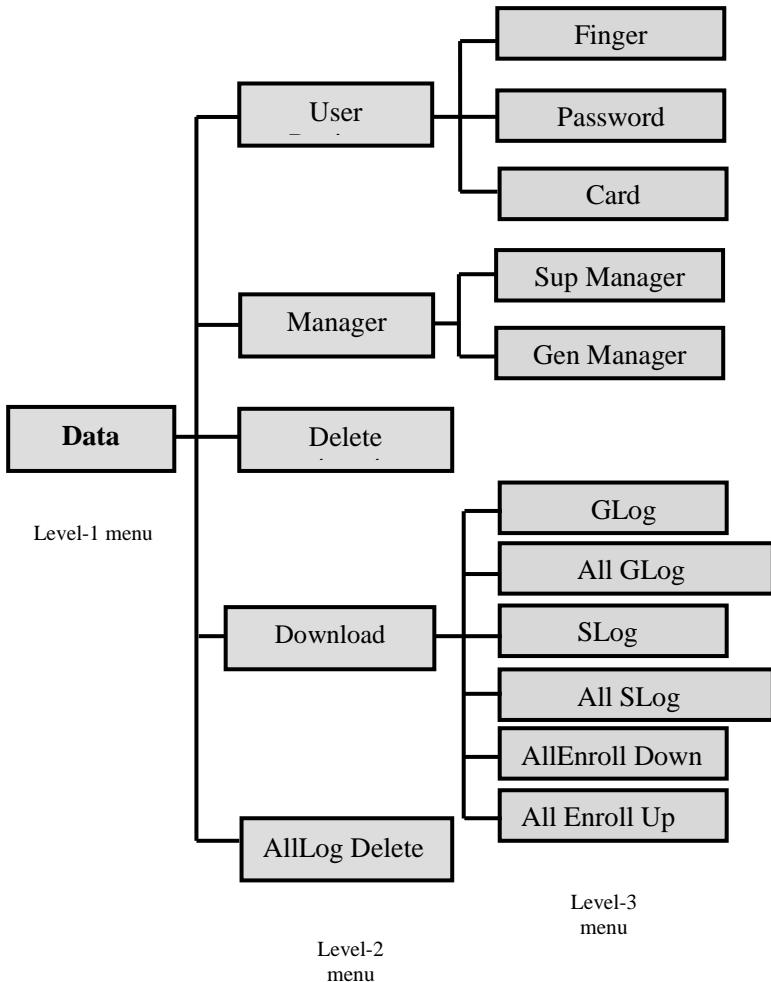

## 7.2 The structure of Settings menu

### 1) System

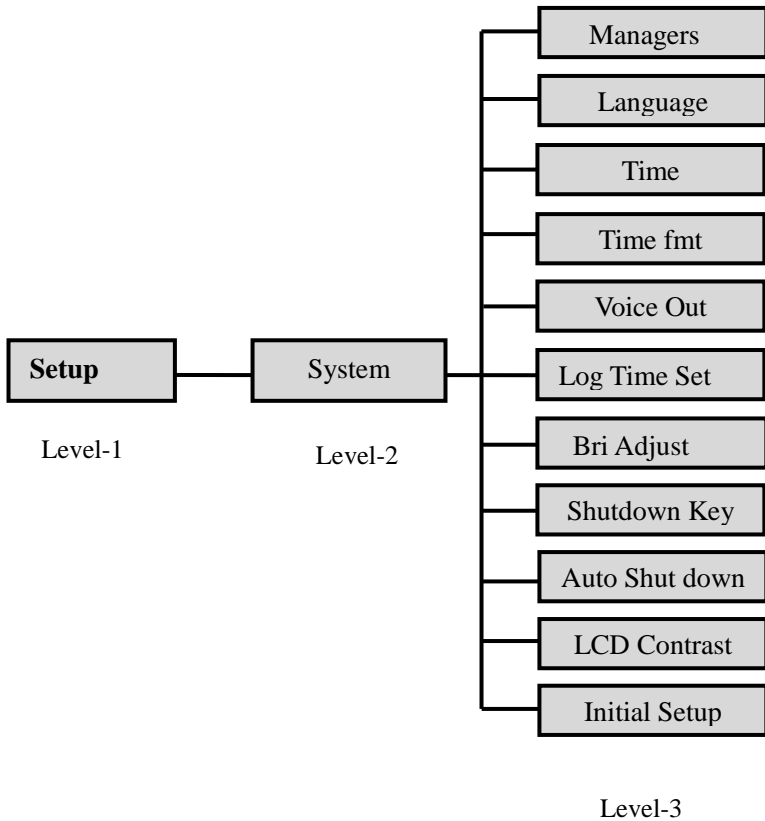

2) Access control

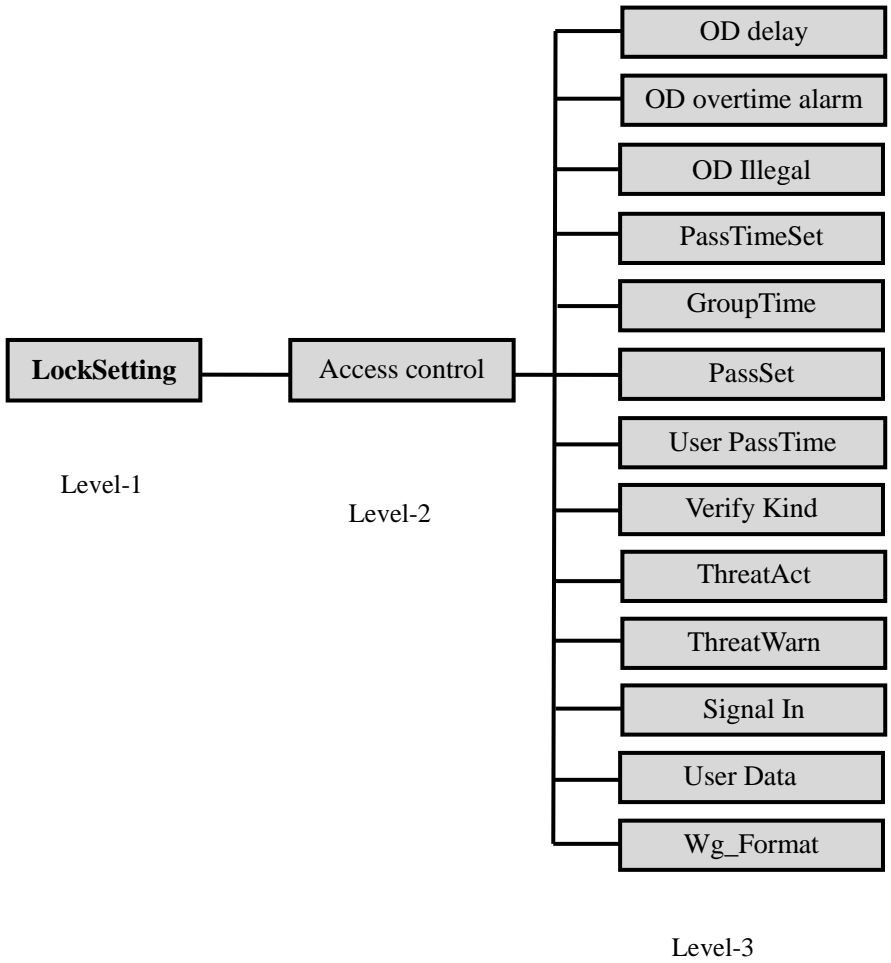

3) Communication and records

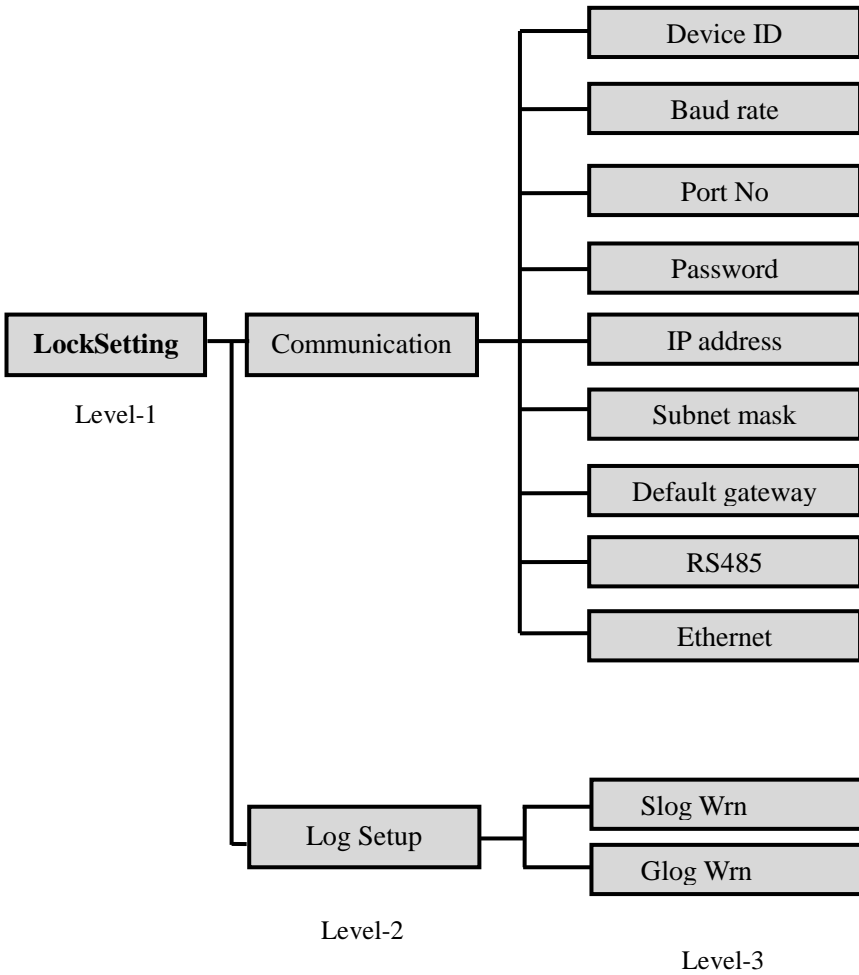



### 7.3 The structure of System Info menu

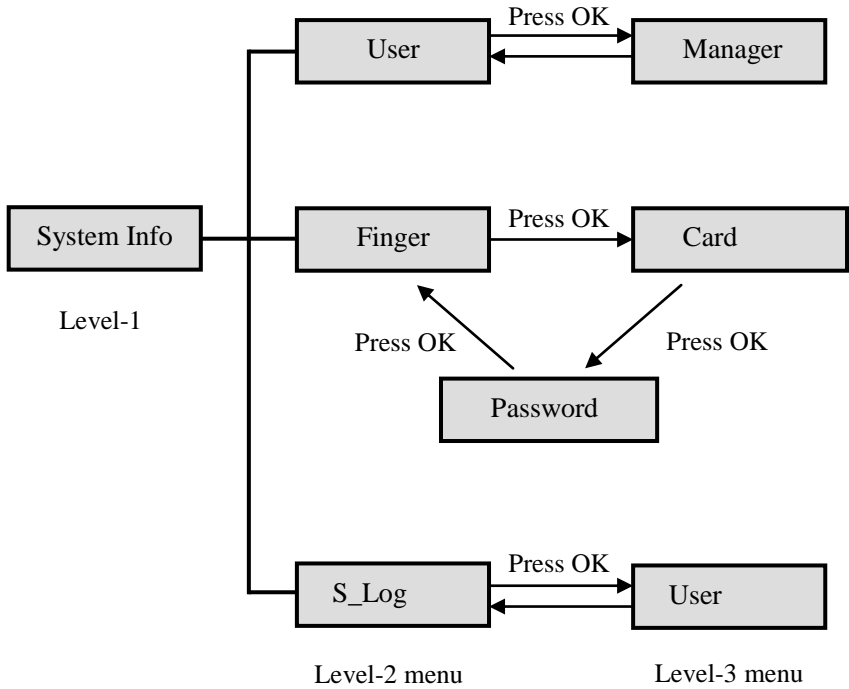

## VIII. Troubleshooting

---

**1. Q: Why the terminal can't find available device when RS485 communication is activated?**

A: Operate in the following method:

- 1) Check whether the device No., baud rate, device type and communication mode set in the management software accord with the settings of the terminal;
- 2) Reduce the baud rate to 9600bps or change another PC;
- 3) Check whether the cable is connected properly; see the hardware manual for the wiring method;

If the problem still exists, please refer to the Warranty Card and contact local service center.

**2. Q: Why the terminal can't find available device when TCP/IP communication is activated?**

A: Follow the steps below:

- 1) Access the [Device Management] – [Connect to Device] – [Connecting Options] menu in the management software and check whether the selected device type in the software is correct;
- 2) The communication mode must be TCP/IP and the searching range is the device number of the terminal; refer to the values set in the terminal for the IP address and port number;
- 3) The [Password] of the terminal is 0 by default; you can change it into your own private password;
- 4) Because the terminal communicates in specified port number, please make sure that the port isn't disabled by the firewall or any other network device (port 80 is available);
- 5) The terminal supports multiple network segments, but you need to pay attention to the setting of subnet mask.

**3. Q: Why the clock of the terminal is inaccurate after a period of time? How to adjust?**

A: The clock chip of the terminal is same to other electric appliance and the error is unavoidable. It is regarded as normal if the clock error is within  $\pm 3$  minutes in one month. You can adjust in the menu of the terminal, or use the management software, or synchronize to the PC time.

**4. What to do if there is no reaction or the reaction is slow when personnel press fingers to check attendance?**

1) Maybe the finger is too dry or too wet; the fingerprint sensor works in optical principle, and it will make the recognition too slow or even can't recognize. Please touch the wet towel with the finger, or wet the finger and wipe to 50% dry to improve the sensitivity and recognition rate;

2) The fingerprint of the employee is rubbed seriously; choose a finger with clear fingerprint and register;

3) The employee doesn't press in the proper way; keep the fingerprint surface parallel to the sensor to keep sufficient contact area and improve the sensing speed.

**5. Why the terminal senses automatically and asks to repress the finger even when no person checks attendance?**

A: Reasons and solutions:

1) The terminal is irradiated by sunshine directly or the position where the terminal is placed has strong light; please move the terminal to another position;

2) The fingerprint sensor is stained with dirt; please wipe with wet soft cloth;

3) Access the menu of the terminal to set the [Bri Adjust]. Please contact local service center if the problem still exists.

**6. Why the LCD of the terminal isn't clear or only has backlight and no characters?**

A: The terminal has the menu [LCD Contrast] and the value should be 22 to 30. If this value is 0, the screen only has backlight but no characters. You can also adjust this option in the management software if the terminal is connected to the PC.

**7. Why the data can't be downloaded to flash memory even when the terminal is integrated with flash memory function?**

A: 1) Various flash memory brands are on market and their qualities are different. Please select flash memory of famous brand (e.g. aigo, Netac, etc) and retry;

2) The flash memory must be formatted if it is used for the first time. To format, the file system should be FAT32.

**8. Q: I use the attendance software for the first time. What should I do?**

A: Refer to the manual of the attendance management software.

**9. Q: What's the operating procedure when new employee is enrolled?**

A: When the terminal is turned on, press the [MENU] button to access the menu, select [Enroll] → [OK] → User → select registration type, for example, select [Finger] → [OK] → [New Enroll?] →, select "Yes" and press the [OK] button → input the registration number → [OK] → follow the prompt and put the finger close to the fingerprint sensor of the terminal to read the fingerprint information → save the new registration and press the [OK] button.