

The Radiator Company 2012 Brochure & Price List Edition 1.

With over 10 years experience we can help you choose the perfect radiator. Within our range you will find radiators that will complement any interior design style and are suitable for any room in the house; living rooms, bedrooms, kitchens, bathrooms, hallways and conservatories. We offer;

The UK's largest range; thousands of combinations from over 70 designs in up to 200 colours and special finishes

Unbeatable Service; making your purchase as smooth as possible

Free delivery; to all mainland UK invoice addresses, (this excludes any offshore islands)

Quality guaranteed; high quality products, with a minimum guarantee of 5 years on all radiators and towel rails

Italian Design & Manufacture; almost all of the products we sell are manufactured in Italy.

Showrooms; over 570 showrooms nationwide, where you can see our products and discuss your order

National Merchant Network; a merchant local to you, to provide helpful advice & order your radiators

Automatic radiator bleed valve; all suitable models come with the HV30 auto airvent which keeps radiators hot to top

www.theradiatorcompany.co.uk; for more information and for our heat output calculator, technical advice & to find your local Showroom or Merchant please visit our website.



Porta 580 x 1060 shown in Brushed Stainless Steel with Ideal TRV valves.

Contents

Contemporary Designer Radiators

	Product	Technical
Metacrylic Shine	6	106
Ice Range	7	106
Flat	8 - 9	108 - 109
Tif	10	107
Loft	11	110
Blade	12	111
Volcano Range	13	110
TRC 13	14 - 15	112 - 113
TRC 16	16	114 - 115
TRC 25 Range	17	116 - 117
Vision 25	18 - 19	118 - 120
TRC 35	20	120
Water Lily	21	122
Vivid	22	121
Tornado Range	23	121
Camino Range	24 - 25	123
Picchio Range	26 - 27	124 - 125
Picchio Triple	28 - 29	126 - 127
Stanza	30	126 - 127
Trim Range	31	128
Volcano Cubed Range	32 - 33	129
	34 - 35	130

Aluminium; Energy Efficient Radiators

Vip & Oscar Royale Range	37 - 39	131
Vip	40	131
Oscar	41	131
Mix	42	132
Vox	43	132
Klass	44	132
Ekos Extra / Ekos 95	45	132

Stainless Steel Radiators

 Valeta	47	134
Omega Range	48 - 49	133
Pillar	50	133
 Porta	51	134
Torus Range	52 - 53	134

Classic Multi Column Radiators

Ancona Made to Order	56 - 59	135 - 137
Ancona with Cast Feet	56	135 - 137
Ancona with Welded Feet	57	135 - 137
Ancona Bench Seat	58	138
Ancona with Wall Brackets	59	135 - 137
Ancona Stock White: Wall Brackets	60	138 - 139
Ancona Stock White: Slip on Feet	61	138 - 139
Ancona Stock White: Cast Feet	62	138 - 139

Traditional Cast Iron Radiators

	Product	Technical
Bianco	64	140 - 141
Ludlow	65	140 - 141
Vecchia	66	142
Trieste	67	142

Bathroom Towel Rails

Ideal for Kitchens, Bathrooms & Cloakrooms

Ice Bagno	69	143
Volcano Towel Rail / 180 A	70	143 / 144
BDO Trim	71	144
Tornado Towel Rail / Trim Towel Rail	72	144 / 145
BDO 25	73	145
 Bath 25 / BD 13	74	145 / 146
Dexter	75	146
Poll Range	76 - 77	147
Lupin White / Lupin Chrome	78	148
Poppy White / Poppy Chrome	79	148 / 149
Picchio Towel Rail / Camino Towel Rail	80	149 / 150
Iris	81	150
Mast / Sail	82	150 / 151
Sudbury / York	83	151 / 151
Chester / Arundel	84	151 / 152
Traditional Ancona	85	152
Panorama / Cambridge	86	152 / 152

Convectors

Perfect for conservatories, hallways and underneath windows.

TRC Skirting	87	153
Mini / Plinth	88	154-155/157
LST	89	156 - 157
Trench	90	158 - 159

Valves & Accessories 91 - 105

Choose from our selection of contemporary & traditional valves suitable for choice of radiator. Accessories include pipe covers, automatic bleed valves & thermostatic elements.

Technical Details & Prices 106 - 159

This section details sizes, prices, outputs & pipe centres for all of our products.

How to buy 160 - 162

Terms & Conditions

VAT will be charged at the prevailing rate at time of invoice; at the time of going to print VAT is 20%.

For a copy of The Radiator Company full Terms & Conditions please call our Customer Services department on **01342 302250** or visit www.theradiatorcompany.co.uk

Contemporary Designer

Automatic Radiator Bleed Valve

The HV30, air vent is included with all suitable Designer Radiators: please refer to the Technical Section for inclusion.



Our contemporary designer range contains models that can be used throughout the home in living rooms, dining rooms, hallways, bedrooms, kitchens, bathrooms, conservatories or a study. Developed to reflect the latest trends in interior design these radiators will complement any modern scheme. The wide selection of sizes, formats and colour options allows you to select the perfect radiator to suit your heat output requirements, available space and interior design.

Knowing the heat output required (BTU/Watts) to heat your room is key when choosing your radiator. For help on calculating this and selecting the correct size of your chosen radiator please see page 160 or visit our website www.theradiatorcompany.co.uk.

Italian Design & Manufacture

Italy has earned a worldwide reputation for being at the leading edge of radiator design; style and practical functionality has produced a whole host of iconic products. We work with some of the best Italian radiator designers and manufacturers to bring you a wide choice of stylish, quality products.

Tube Style & Size

Using a variety of materials and manufacturing techniques, numerous tube styles and shapes are possible. A wide choice of sizes in round, square, rectangular and flat tubes provide a range of subtle changes in scale and proportion so you can perfectly match your taste. Matching towel rails allow your theme to continue throughout every room.

Round

The UK's largest selection with tube sizes of 13mm, 16mm, 25mm & 35mm.



Square & Rectangular

Developed to match ultra modern & minimalist interiors.



Flat Tube

Clean lines which can create subtle or bold statements.



Flat Covers & Shapes

Unbroken lines and contemporary geometric shapes.



Patented Design

Our exclusive patented tube designs provide extra output & a better BTU per £.



Feature Radiators

These ranges offer the latest trends for designer radiators.



Vertical & Horizontal



Almost all of the designer range comes in both vertical and horizontal versions so you can find a radiator to suit any space (some also have matching towel rails).

Colours

Personalise your radiator using a RAL colour or special finish. You can select your preferred colour from the Colour Group associated with your chosen radiator; please specify your selection when you place your order. The Colour Groups for the designer range are:



25 RAL colours including white 9010 as standard plus 14 special finishes

1001 1013 1015 1016 1021 2003 3000 3003 3015
5002 5012 5014 5017 6019 6027 7016 7035 7042
8011 9001 9005 9006 9007 9010 9011



17 RAL colours including white 9010 as standard plus 7 special finishes.

1013 1015 1021 3000 3002 3003 3004 5014 5021
6016 7016 7035 9005 9006 9007 9010 9011



188 RAL colours including white 9010 as standard plus 11 special finishes

Available in the complete RAL range, plus additional special colours including gun metal grey, textured white and ivory, mottled and antique finishes.



188 RAL colours including white 9003 as standard plus 8 special finishes

Available in the complete RAL range plus 8 special finishes including white & grey aluminium, gloss & matt silver.

Many of our most popular white designer models are also available from stock & can be delivered within 3–5 working days. Call **01342 302250** for a RAL chart and samples of our special finishes.

Accessories

For our full range of accessories please see pages 101 to 105.

Keep radiators clean with our specially designed brushes.

Pipe covers and shrouds fit over the copper feed pipe to create a matching finish to your valves.



Single, Double & Triple



Increase the heat output using a double or triple radiator without compromising space or design integrity.

Valves & Matching Painted Valves

Complement your designer radiator with a contemporary and stylish valve; see pages 92 to 100 for our full selection. Almost all of our valves are available in chrome, white & nickel finishes.



Painted Valves

Exclusive to the Ancona, Volcano, Volcano Cubed and Tornado radiators and matching towel rails, is the option to fully coordinate your radiator colour with your valves and pipe covers to create a unique and individual statement.

A select range of valves (shown below) can be painted in any of the 188 RAL options plus 11 exclusive special finishes from colour group 9, see page 96 for full details. Please note; these must be ordered at the same time and in the same colour as your radiator.



Underneath Connections (B2)

Most radiators are supplied with Bottom Opposite End (BOE) connections as standard. However in some cases selected radiators can be supplied with optional Underneath Connections allowing the valve to be positioned under the radiator, for situations where space is tight or for creating a neater finish.

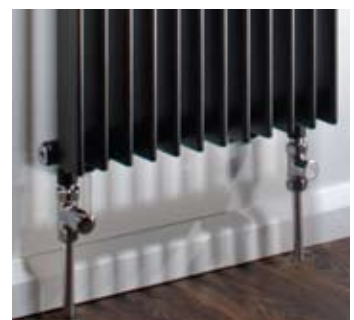

Metacrylic

The Metacrylic combines an efficient steel tube radiator with striking acrylic overlay.



Wall 1820 x 560, shown in Black on White option with Standard valves.

Design Options

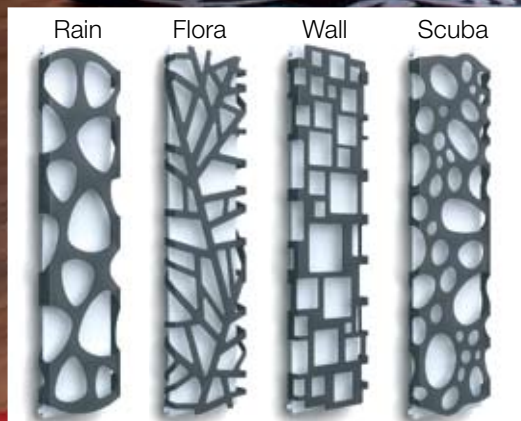

Choose a design style (Wall, Flora, Rain or Scuba) and then choose a colour option e.g. Black on White. You can choose any colour option with any design.

Product Information

Technical Details & Prices page 106

21 vertical models
4 design options
3 heights from 1220mm to 2020mm
Outputs from 2126 to 3509 Btu's
Optional underneath connections; see page 5.

Colours



Red on Satinato



Black on Satinato



Clear on Satinato



Clear on Black



Verde on White



Red on white

Delivery

7 weeks.
See page 106 on how to order your Metacrylic radiator.

Shine

Lit via LED lights built into the acrylic cover this impressive radiator comes to life at night. Using a discrete built in dimmer; a range of light levels is achievable to create different mood lighting effects.

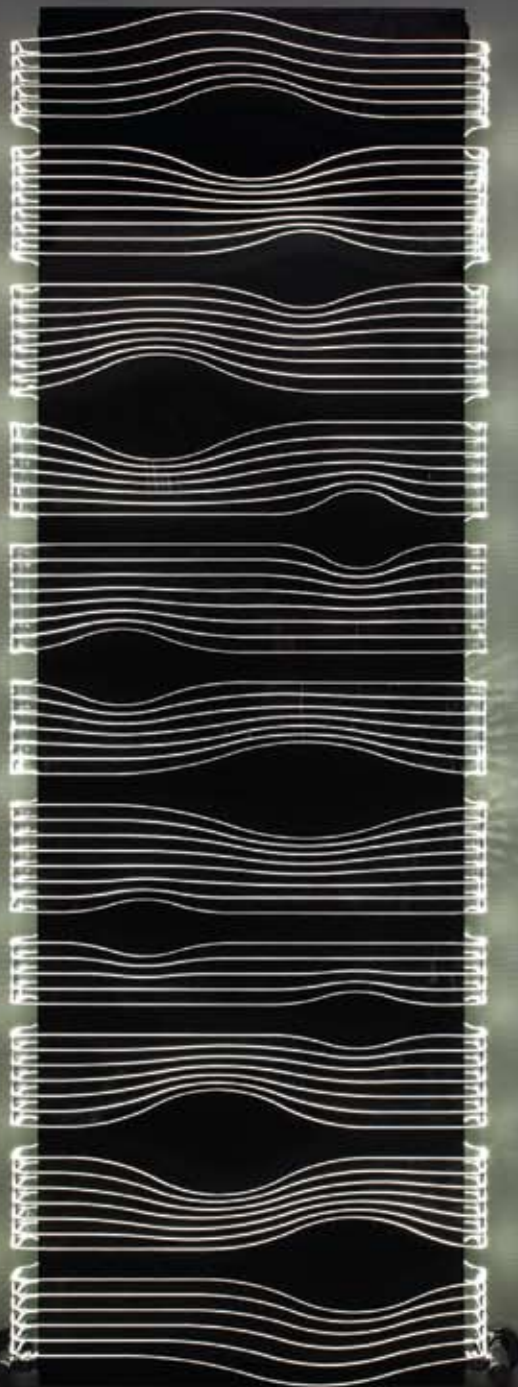

Shine 1820 x 590 shown in Black.

Product Information

Technical Details & Prices page 106

1 vertical model.
Output 3154 Btu's

Please Note: The Shine uses a 12v transformer (provided) to power the LED lighting. A suitable plug socket is required.

Colours

Available in 2 finishes, Black or White radiator with clear acrylic cover.

Delivery

7 weeks.

Ice Range

The Ice range combines italian made flat tube steel radiator cloaked in a steel cover and is available in a variety of configurations; horizontals, verticals, singles & doubles. For matching towel rails see page 69.



Ice horizontal 465 x 1220, in Matt Grey shown with Cylinder valves.



Ice Inox in Polished Stainless Steel.

Product Information

Technical Details & Prices pages 108-109

Ice; 36 Horizontal & Vertical models in Singles & Doubles

Ice Inox; 36 Horizontal & Vertical models in Singles & doubles,
Outputs from 1365 to 6940 Btu's
Optional underneath connections; see page 5.

Colours

Please call 01342 302250 for colour charts.

2 Choose from 17 RAL colours & 7 special finishes (white 9010 as standard).

1013 1015 1021 3000 3002 3003 3004 5014
5021 6016 7016 7035 9005 9006 9007 9010
9011

Ice Inox; polished or brushed stainless steel only.

Delivery

3 - 5 working days for stock lines

4 weeks non stock white,
6 weeks colours,
8 weeks for non stocked stainless steel.



Ice double vertical 1820 x 465, shown in RAL 9010.

Flat

The smooth surface of the Flat has been stylised by the addition of a single row of round holes.



Flat single vertical 1725 x 495, shown in RAL 9010.

Product Information

Technical Details & Prices page 107

12 Horizontal models in Single & Double
12 Vertical models in Single & Double
Outputs from 3584 to 11679 Btu's
Optional underneath connections; see page 5.

Colours

Please call 01342 302250 for colour charts.

 Choose from 25 RAL colours & 14 special finishes (white 9010 as standard)

1001 1013 1015 1016 1021 2003 3000 3003 3015
5002 5012 5014 5017 6019 6027 7016 7035 7042
8011 9001 9005 9006 9007 9010 9011

Delivery

6 weeks for white
6 weeks for colours.

Tif

The Tif is perfectly flat, with soft rounded edges and great outputs.



Tif vertical 1730 x 398, shown in RAL 3000.

Product Information

Technical Details & Prices page 110

6 Horizontal models, 6 Vertical models
Outputs from 3157 to 6792 Btu's
Optional underneath connections; see page 5.

Colours

Please call **01342 302250** for colour charts.

1 Choose from 25 RAL colours & 14 special finishes (white 9010 as standard)

1001 1013 1015 1016 1021 2003 3000 3003 3015
5002 5012 5014 5017 6019 6027 7016 7035 7042
8011 9001 9005 9006 9007 9010 9011

Delivery

3 - 5 working days for stock white

6 weeks for non stock white & colours.

Loft

The Loft is a simple corrugated design made from aluminum that generates a big impression and great outputs.



Loft 1700 x 403, shown in RAL 9010.

Product Information

Technical Details & Prices page 111

9 Horizontal models
9 Vertical models
Outputs from 1147 to 4495 Btu's

Colours

Please call **01342 302250** for colour charts.

 **Choose from 25 RAL colours & 14 special finishes (white 9010 as standard)**

1001 1013 1015 1016 1021 2003 3000 3003 3015
5002 5012 5014 5017 6019 6027 7016 7035 7042
8011 9001 9005 9006 9007 9010 9011

Delivery

5 weeks for white
5 weeks for colours.

Blade

Made from aluminium, this subtle surf board design gives the Blade universal appeal.



Blade vertical 1700 x 250, shown in RAL 9010.

Product Information

Technical Details & Prices page 110

1 Horizontal model
1 Vertical model
Output 1372 Btu's

Colours

Please call **01342 302250** for colour charts.

1 Choose from **25 RAL colours & 14 special finishes (white 9010 as standard)**

1001 1013 1015 1016 1021 2003 3000 3003 3015
5002 5012 5014 5017 6019 6027 7016 7035 7042
8011 9001 9005 9006 9007 9010 9011

Delivery

3 - 5 working days for stock white

6 weeks for colours.

Volcano Range

Exclusive to The Radiator Company, the Volcano's efficient patented horseshoe shaped tube delivers incredible output for its size and superb value for money. For matching towel rail please see page 70.



Volcano single horizontal 520 x 1471, shown in RAL 9010 with Ideal TRV valves.

Horseshoe shaped tube means greater output can be achieved.

Product Information

Technical Details & Prices pages 112-113

50 Horizontal models in Single & Double
60 Vertical models in Single & Double
Outputs from 1177 to 16468 Btu's
Optional underneath connections; see page 5.

Colours

Please call 01342 302250 for colour charts.

 Choose from 188 RAL colours & 11 special finishes (white 9010 as standard)

Available in the complete RAL range plus special colours including gun metal grey, textured and mottled finishes.

Delivery

3 - 5 working days for stock white

4 weeks non stock white,
4 weeks colours.



Volcano double vertical 1771 x 400, in Textured Dark Grey with matching Valves, Pipe covers & Shrouds.

TRC 13

The TRC 13 is the sleekest of our tubular radiators and is available in a striking chrome or nickel finish for single models.



TRC 13 single vertical 1800 x 512, shown in RAL 9010.

Product Information

Technical Details & Prices pages 114-115

31 Horizontal models in Single & Double
39 Vertical models in Single & Double
Outputs from 1543 to 8509 Btu's
Optional underneath connections; see page 5.

Colours

Please call **01342 302250** for colour charts.

 Choose from **25 RAL colours & 14 special finishes plus Nickel & Chrome (white 9010 as standard)**

1001 1013 1015 1016 1021 2003 3000 3003 3015
5002 5012 5014 5017 6019 6027 7016 7035 7042
8011 9001 9005 9006 9007 9010 9011

Delivery

3 - 5 working days for stock lines

4 weeks non stock white,
6 weeks colours,
8 weeks for non stock chrome / nickel

TRC 16

With 16mm diameter tubes, the TRC 16 is the second option in our range of tubular designs.



TRC 16 single vertical 1210 x 378, shown in RAL 9010 with Ellipse valves.

Product Information

Technical Details & Prices pages 116-117

34 Horizontal models in Single & Double
48 Vertical models in Single & Double
Outputs from 754 to 8533 Btu's
Optional underneath connections; see page 5.

Colours

Please call **01342 302250** for colour charts.

2 Choose from **17 RAL colours & 7 special finishes (white 9010 as standard).**

1013 1015 1021 3000 3002 3003 3004 5014
5021 6016 7016 7035 9005 9006 9007 9010
9011

Delivery

3 - 5 working days for stock white

4 weeks non stock white,
6 weeks colours.

TRC 25 Range

The TRC 25 is our most popular of steel tubular radiators, available in a wide variety of configurations.



TRC 25 double horizontal 440 x 1400 shown in GRPR.



BDO 25; see pages 73 & 74 for matching towel rails

Product Information

Technical Details & Prices pages 118-120

52 horizontal models in singles & doubles
68 Vertical models in singles and doubles
15 Vertical Chrome models
Outputs from 546 to 9440 Btu's
Optional underneath connections; see page 5.

Colours

Please call 01342 302250 for colour charts.

 Choose from 25 RAL colours, 14 special finishes plus chrome (white 9010 as standard)

1001 1013 1015 1016 1021 2003 3000 3003 3015
5002 5012 5014 5017 6019 6027 7016 7035 7042
8011 9001 9005 9006 9007 9010 9011

Delivery

3 - 5 working days for stock lines

4 weeks non stock white,
6 weeks colours.
8 weeks for non stock chrome



TRC 25 single vertical 1800 x 512 shown in RAL 9010.

Vision 25

These practical & versatile radiators are supplied with one of three mirrors; please specify mirror (A, E or F) when placing your order.



Vision 25 single, 2000 x 584 shown in RAL ARRГ with Mirror E.

Product Information

Technical Details & Prices page 120

16 Vertical models in Single & Double
Outputs from 3679 to 9645 Btu's
Optional underneath connections; see page 5.

Colours

Please call **01342 302250** for colour charts.

 **Choose from 25 RAL colours, 14 special finishes (white 9010 as standard)**

1001 1013 1015 1016 1021 2003 3000 3003 3015
5002 5012 5014 5017 6019 6027 7016 7035 7042
8011 9001 9005 9006 9007 9010 9011

Delivery

6 weeks for white & colours

TRC 35

The largest of all our steel tubular radiators, the TRC 35 is available as a single configuration in vertical & horizontal.



TRC 35 single vertical 1700 x 488 shown in RAL 9010.

Product Information

Technical Details & Prices page 122

24 models; Horizontals & verticals,
Outputs from 2082 to 4143 Btu's
Optional underneath connections; see page 5.

Colours

Please call 01342 302250 for colour charts.

 Choose from 25 RAL colours, 14 special finishes (white 9010 as standard)

1001 1013 1015 1016 1021 2003 3000 3003 3015
5002 5012 5014 5017 6019 6027 7016 7035 7042
8011 9001 9005 9006 9007 9010 9011

Delivery

3 - 5 working days for stock white

4 weeks non stock white,
6 weeks colours.

Water Lily

Perfect for rooms where space is at a premium and a slim line vertical model is needed.

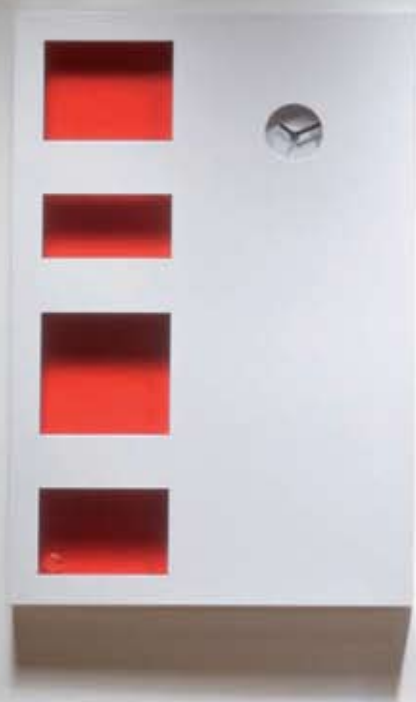

Water Lily 2010 x 155 in RAL 9005 with underneath connections.

Product Information

Technical Details & Prices page 121

5 vertical models; 2, 3, 4, 5 & 6 panel in 1 height.
Outputs from 1112 to 3341 Btu's
Underneath connections as standard.

Colours

Please call **01342 302250** for colour charts.

2 Choose from 17 RAL colours & 7 special finishes (white 9010 as standard).

1013 1015 1021 3000 3002 3003 3004 5014
5021 6016 7016 7035 9005 9006 9007 9010
9011

Delivery

3 - 5 working days for stock white

6 weeks for colours.

Vivid

Large flat fins contribute to exceptional outputs and a strong visual statement.



Vivid 1810 x 480 shown in RAL 9010 with Ellipse valves.

Product Information

Technical Details & Prices page 121

20 models; verticals & horizontals
Outputs from 2478 to 6570 Btu's
Optional underneath connections; see page 5.

Colours

Please call **01342 302250** for colour charts.

 Choose from **17 RAL colours & 7 special finishes (white 9010 as standard).**

1013 1015 1021 3000 3002 3003 3004 5014
5021 6016 7016 7035 9005 9006 9007 9010
9011

Delivery

4 weeks for white,
6 weeks for colours.

Tornado Range

The Tornado's 68mm patented tube features a modern flat profile front with a fluted rear design giving great heat performance.



Tornado single horizontal 456 X 1471 shown in exclusive finish Gun Metal Grey with matching Cylinder valves, pipe shrouds & covers.



Please see page 72 for matching Tornado towel rail.

Product Information

Technical Details & Prices page 123

30 Horizontal models in singles & doubles
30 Vertical models in singles & doubles
Outputs from 1659 to 9051 Btu's
Optional underneath connections; see page 5.

Colours

Please call **01342 302250** for colour charts.

 **Choose from 188 RAL colours & 11 special finishes (white 9010 as standard)**

Available in the complete RAL range plus special colours including gun metal grey, textured and mottled finishes.

Delivery

3 - 5 working days for stock white

6 weeks for non stock white & colours.



Tornado double vertical 1471 x 456, in RAL 9010 shown with Curve valves, with matching Covers & Shrouds.

Camino Range

With slim styled 35mm cross tubes the Camino is available in a range of configurations including singles, doubles and triples.



Camino single horizontal 645 x 1510, shown in RAL 9010.

Camino Side Panels;

On double and triple models optional side panels are available to give a neater finish, (see image on right), please specify at time of order.



Camino triple horizontal with optional side panels.

Product Information

Technical Details & Prices pages 124-125

57 horizontal models in singles, doubles & triples
57 vertical models in singles, doubles & triples
Outputs from 689 to 14287 Btu's
Optional underneath connections; see page 5.

Colours

Please call **01342 302250** for colour charts.



Choose from 17 RAL colours & 7 special finishes (white 9010 as standard).

1013 1015 1021 3000 3002 3003 3004 5014
5021 6016 7016 7035 9005 9006 9007 9010
9011

Delivery

3 - 5 working days for stock white

4 weeks for non stock white,
6 weeks for colours.



Camino Towel Rail see page 80 for details.

Camino single vertical 1510 x 645, shown in white RAL 9010.

Picchio Range

The Picchio has one of the widest ranges of options with single, double & triple configurations.



Picchio double horizontal 455 x 1010, shown in RAL 1013, Oyster White with Cylinder valves.

Picchio Side Panels;

On double and triple models optional side panels are available to give a neater finish, (see page 30 for side panels on a Picchio Triple), please specify at time of order.



Picchio Towel Rail see page 80 for details.

Product Information

Technical Details & Prices pages 126-128

59 horizontal models in singles, doubles & triples
65 vertical models in singles, doubles & triples
Outputs from 676 to 9966 Btu's
Optional underneath connections; see page 5.

Colours

Please call **01342 302250** for colour charts.

2 Choose from 17 RAL colours, 7 special finishes & Chrome (white 9010 as standard).

1013 1015 1021 3000 3002 3003 3004 5014
5021 6016 7016 7035 9005 9006 9007 9010
9011

Delivery

3 - 5 working days for stock lines

4 weeks for non stock white,
6 weeks for colours,
6 weeks for non stock chrome.



Picchio single vertical 1810 x 455, shown in RAL 9010.

Picchio Triple

The Picchio Triple delivers extremely high outputs and is great for tight vertical & horizontal spaces.



Picchio Triple vertical 1510 x 455 in Matt Black with optional side panels and Ideal TRV valves.

Product Information

Technical Details & Prices pages 126-127

15 horizontal models
15 vertical models
Outputs from 2457 to 9966 Btu's

Colours

Please call **01342 302250** for colour charts.

2 Choose from 17 RAL colours, 7 special finishes (white 9010 as standard).

1013 1015 1021 3000 3002 3003 3004 5014
5021 6016 7016 7035 9005 9006 9007 9010
9011

Delivery

4 weeks for white,
6 weeks for colours.

Stanza

An outstanding radiator with large 30 x 40mm vertical tubes.



Stanza vertical, 1700 x 480 shown in RAL 9007 with Mini Cube valves.

Product Information

Technical Details & Prices page 128

10 horizontal models;
10 vertical models;
Outputs from 1601 to 5942 Btu's

Colours

Please call 01342 302250 for colour charts.



Choose from 188 RAL colours plus 8 special finishes (white 9003 as standard).

Delivery

3 - 5 working days for stock white

4 weeks for non stock white,
6 weeks for colours.



Trim Range

With slim 15mm x 20mm rectangular tubes the Trim is a sleek design with plenty of options to fulfil all requirements.



Trim double horizontal 488 x 1200 shown in RAL 9010.



BDO Trim; see page 71 / 72 for matching towel rails.

Product Information

Technical Details & Prices page 129

32 horizontal models in single & double
32 vertical models in single & double
Outputs from 1055 to 9963 Btu's
Optional underneath connections; see page 5.

Colours

Please call 01342 302250 for colour charts.

1 Choose from 25 RAL colours, 14 special finishes (white 9010 as standard)

1001 1013 1015 1016 1021 2003 3000 3003 3015
5002 5012 5014 5017 6019 6027 7016 7035 7042
8011 9001 9005 9006 9007 9010 9011

Delivery

3 - 5 working days for stock white

5 weeks for non stock white,
6 weeks colours.



Trim single vertical 1600 x 584, shown in special finish GRGR.

Volcano Cubed Range

The unique patented horseshoe shape tube delivers dramatically increased output compared to another radiator of similar size.



Volcano Cubed double horizontal 520 x 971, shown in RAL 9010 with Ideal TRV valves.



Volcano Cubed horseshoe profile gives greater outputs.

Product Information

Technical Details & Prices page 130

30 horizontal models in singles & doubles
30 vertical models in singles & doubles
Outputs from 2061 to 13498 Btu's
Optional underneath connections; see page 5.

Colours

Please call **01342 302250** for colour charts.

 **Choose from 188 RAL colours & 11 special finishes (white 9010 as standard)**

Available in the complete RAL range plus special colours including gun metal grey, textured and mottled finishes.

Delivery

3 - 5 working days for stock white

4 weeks for non stock white,
6 weeks for colours.



Volcano Cubed single vertical 1971 x 400 shown in Textured Dark Grey with matching Cylinder valves.

Contemporary Aluminium

Smooth clean lines and slim profiles make this range perfect for both new homes and as replacement radiators. Their practical functionality makes them suitable for living rooms, bedrooms or studies and our variety of accessories can also enhance their use in kitchens, bathrooms and hallways.

Italian Design & Manufacture

Italy has earned a worldwide reputation for being at the leading edge of radiator design; style and practical functionality has produced a whole host of iconic products. We work with some of the best Italian radiator designers and manufacturers to bring you a wide choice of stylish, quality products.

Energy efficient

- Aluminium has a very high thermal efficiency, transferring heat efficiently from the water to the radiator. They require much lower volumes of water to heat up and this helps reduce fuel bills when compared to other radiators.
- This thermal efficiency also makes them very easy to control and fast to respond to changes in temperature, heating up and cooling down quickly.
- Aluminium radiators are more lightweight making them easy to handle and install, especially on stud walls.

The use of renewable energy sources is on the increase;

- Heating systems fuelled by renewable energy tend to work with lower water temperatures than oil or gas fuelled systems; this will affect the heat output achievable from any radiators.
- The thermal properties of aluminium make this type of radiator more efficient with low temperature systems and reduces the need for a larger radiator to achieve required heat output.
- In some situations there is a need to mix radiators and under floor heating on the same system. Aluminium radiators are a good option in these cases, as under floor heating tends to run on lower system temperatures.

TRV Valves

Thermostatic Radiator valves automatically control the heat output of individual radiators. Sensors within the head of the valve adjust the flow of water to the radiator depending on the ambient room temperature. TRVs are now required as part of building regulations on new builds and most conversion projects. See pages 92 - 100 for the complete range.



Royale Special Finishes

Our unique Royale range provides 4 exclusive special finishes in set sizes from our Vip and Oscar ranges. Complete with end panels, these radiators provide both the efficiencies of aluminium and a stunning finish.



Accessories

Aluminium accessories include a specially designed brush to clean the radiators, hanging pegs, towel bars and for the Oscar and Vip, end panels to create a clean side profile. See page 103 for details.

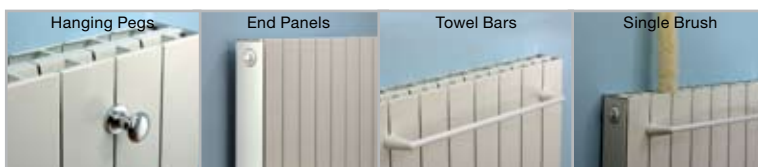

Automatic Radiator Bleed Valve

The HV30 air vent is included with all suitable Aluminium radiators: please refer to the Technical Section for inclusion.



Vip & Oscar Royale

We have given our stock white aluminium lines (Vip & Oscar) the royal treatment. With 4 striking powder coated special finishes and fitted with end panels as standard, these models have all the benefits of Aluminium's thermal properties giving them great outputs and fast response to changes in temperature; as well as a unique designer style.



Vip Royale 690 x 800 shown in Polished Silver with Mini Cube valves.

Product Information

Technical Details & Prices page 131

Vip Royale; 8 models in 2 heights & 4 widths.
Oscar Royale; 8 models in 2 heights & 4 widths.
Set sizes only. End panels come as standard.
Outputs from 2133 to 8109

Colours

Available in Textured Light Grey, Textured Black Gold, Textured Matt Black and Polished Silver.

Please call **01342 302250** for colour charts.

Delivery

3 - 5 working days for all finishes

Vip & Oscar Royale



Vip Royale 690 x 640 shown in Black Gold with Cylinder valves.



Oscar Royale in Matt Black

Technical Details & Prices page 131

Vip Royale; 8 models in 2 heights & 4 widths.
Oscar Royale; 8 models in 2 heights & 4 widths.
Set sizes only. End panels come as standard.
Outputs from 2133 to 8109

Colours

Available in Textured Light Grey, Textured Black Gold, Textured Matt Black and Polished Silver.
Please call **01342 302250** for colour charts.

Delivery

3 - 5 working days for all finishes

Special Finishes



Light Grey
(textured)



Black Gold
(textured)



Polished Silver



Matt Black
(textured)

Please note, due to the printing process, these colours may not be representative of the true finished colour. For samples please call 01342 302250.



Vip

The Vip can be complemented with optional end panels to complete a minimalist design; please specify when you place your order.



Vip 9 sections 590mm high, shown in white RAL 9010 with Ideal TRV valves.

These optional end panels create a flush, smooth appearance, please specify when placing your order. See page 103 for more information

Product Information

Technical Details & Prices page 131

Over 90 combinations available; 5 height options in up to 20 sections.
Outputs per section from 321 to 614 Btu's.

Colour

White RAL 9010 only.

Delivery

3 - 5 working days

Please Note: Supplied pre-assembled in up to 20 sections (1600mm wide)
Wider radiators must be joined on site.

Oscar

The Oscar is great if you are tight on wall space but need higher output, it can also be supplied with matching end panels.



Oscar 4 sections 1846mm high, shown in white RAL 9010 with optional end panels and Ideal TRV valves.

Product Information

Technical Details & Prices page 131

Over 50 combinations available; 5 height options in up to 10 sections.
Outputs per section from 597 to 1096 Btu's.

Colour

White RAL 9010 only.

Delivery

3 - 5 working days

Please Note: Supplied pre-assembled in up to 10 sections (800mm wide)
Wider radiators must be joined on site.

Mix

The Mix has a simple flat design with a small vented feature at the top.



Mix 8 section 690mm high, shown in white RAL 9010 with Ideal TRV valves.

Product Information

Technical Details & Prices page 132

Over 90 combinations available; 5 height options in up to 20 sections.
Outputs per section from 294 to 614 Btu's.

Colour

White RAL 9010 only.

Delivery

3 - 5 working days

Please Note: Supplied pre-assembled in up to 20 sections (1600mm wide)
Wider radiators must be joined on site.

Vox

The Vox has a subtle curved head making this radiator very tactile.



Vox 7 section 790mm high, shown in white RAL 9010.

Product Information

Technical Details & Prices page 132

Over 90 combinations available; 5 height options in up to 20 sections.
Outputs per section from 324 to 618 Btu's.

Colour

White RAL 9010 only.

Delivery

3 - 5 working days

Please Note: Supplied pre-assembled in up to 20 sections (1600mm wide)
Wider radiators must be joined on site.

Klass

The Klass has the slimmest profile of all our sectional aluminium radiators.



Klass 7 section 582mm high, shown in white RAL 9010 with Cylinder valves.



Slim profile 80mm depth

Product Information

Technical Details & Prices page 132

90 combinations available; 5 height options in up to 20 sections.
Outputs per section from 290 to 553 Btu's.

Colour

White RAL 9010 only.

Delivery

3 - 5 working days

Please Note: Supplied pre-assembled in up to 20 sections (1600mm wide)
Wider radiators must be joined on site.

Ekos Range

The Ekos Range is available in two profile options; 95mm section and 130mm section.

The Ekos Extra is the big brother of the Ekos 95 and can be installed in locations where space is at a premium.



Ekos 95, 10 section 668mm high



Ekos Extra 6 section 1870mm high, shown in white RAL 9010 with Ideal TRV valves.

Product Information

Technical Details & Prices page 132

Over 200 combinations; 4 heights for Ekos 95, 7 for Ekos Extra, 2 for Ekos 130 in up to 20 sections (10 for Ekos Extra) Outputs per section from 208 to 669 Btu's.

Colour

White RAL 9010 only.

Delivery

3 - 5 working days

Please Note: Ekos 95 / 130 Supplied pre-assembled in up to 20 sections (1000mm wide) Ekos Extra up to 10 sections (500mm) Wider radiators must be joined on site.

Contemporary Stainless Steel



Stainless steel radiators have become increasingly popular over the past few years due to its distinctive contemporary style and longevity. Our range of hand welded and hand finished stainless steel designs can be used as one off statement pieces or throughout the home; in living rooms, dining rooms, hallways, bedrooms, kitchens, bathrooms, conservatories or a study. All models are available from stock and can be delivered in 3-5 working days.

Knowing the heat output (BTU/Watts) required to heat your room is key when choosing your radiator. For help on calculating this and selecting the correct size of your chosen radiator please see page 160 or visit our website www.theradiatorcompany.co.uk.

Stainless Steel

- The natural beauty of our stainless steel range has gravitas all of its own; a strong but subtle presence.
- With a finish often compared to chrome and nickel, stainless steel delivers much greater heat output, about 15%-20% more, as it does not suffer from the loss of output which is an inherent result of the chroming process.
- This range of hand produced radiators are made from 304 grade stainless steel which is highly corrosion resistant. As a non ferrous metal stainless steel will not rust or flake, making them suitable for both direct and indirect systems.
- Our quality of manufacture and their corrosion resistant properties means we can offer a 20 year guarantee on these stainless steel radiators; as long as they are installed according to the manufacturer's instructions.

Styles

Stainless Steel has its own distinctive look, presenting the steel in a brushed natural finish (rather than painted) creates a contemporary loft style, with the larger tube designs having an almost industrial feel.

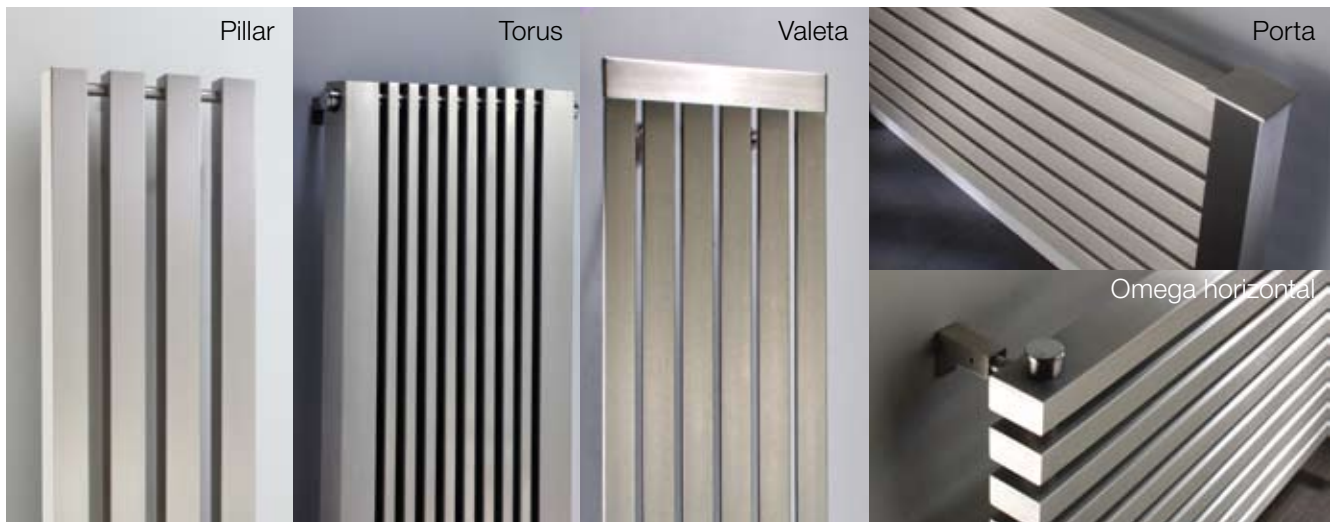

Valves

Our valves bodies are made from solid brass, a material with similar anti corrosion properties to stainless steel. Choose a chrome or nickel finish to complement your stainless steel radiator.



Valeta NEW

Available in 9 sizes the Valeta appears to float off the wall, discrete valve connections are hidden behind the radiator.



Valeta 1500 x 290 shown in Brushed Stainless Steel with Ideal TRV valves.



Valves are positioned behind the radiator.

Product Information

Technical Details & Prices page 134

9 models available.
Outputs from 1751 to 3890 Btu's.

Colour

Available in Brushed Stainless Steel only.

Note: Valves are positioned behind the radiator.

Delivery

3 - 5 working days

Omega Range

Large rectangular tubes, with integral hand welded cross tubes, create a bold statement.



Omega horizontal 459 x 1000 shown in Brushed Stainless Steel with Nickel Ideal TRV valves.

Product Information

Technical Details & Prices page 133

9 models in horizontal & vertical configurations.
Outputs from 2396 to 7282 Btu's.

Colour

Available in Brushed Stainless Steel only.

Delivery

3 - 5 working days



Omega vertical 1800 x 508 shown in Brushed Stainless Steel with Nickel Mini Cube valves.

Pillar

3, 4 or 5 tube options create immediate impact and generate high heat outputs from the large 60mm x 60mm tubes.



Pillar 1800 x 345 shown in Brushed Stainless Steel with Nickel Mini Cube valves.

Product Information

Technical Details & Prices page 133

9 models available.
Outputs from 1672 to 4313 Btu's.

Colour

Available in Brushed Stainless Steel only.

Delivery

3 - 5 working days

Porta NEW

Slim horizontal cross tubes sit inside substantial supporting legs for a distinctive style.



Porta 580 x 1060 shown in Brushed Stainless Steel with Ideal TRV valves.

Product Information

Technical Details & Prices page 134

6 models available.
Outputs from 2081 to 3622 Btu's.

Colour

Available in Brushed Stainless Steel only.

Delivery

3 - 5 working days

Torus Range

A strong yet subtle presence is created by the combination of large 60mm x 60mm and slim 20mm x 60mm tubes.



Torus 750 x 585 shown in Brushed Stainless Steel with Nickel Ideal TRV valves.



Product Information

Technical Details & Prices page 134

4 models available.
Outputs from 3143 to 6034 Btu's.

Colour

Available in Brushed Stainless Steel only.

Delivery

3 - 5 working days



Torus 1800 x 340 shown in Brushed Stainless Steel with Nickel Ideal TRV valves.

Classic Steel Multi Column

Steel Multi column radiators take the classic look of cast iron and combine it with the flexibility of steel; suitable for living rooms, dining rooms, hallways, bedrooms, kitchens, bathrooms, conservatories or a study. The Ancona range is available in two ways; Ancona® made to order & Ancona® from stock.

Italian Design & Manufacture

Italy has earned a worldwide reputation for being at the leading edge of radiator design; style and practical functionality has produced a whole host of iconic products. We work with some of the best Italian radiator designers and manufacturers to bring you a wide choice of stylish, quality products.

Ancona® made to order



- Made to Order
- 2, 3, 4, 5 & 6 column options
- 15 heights; 220mm up to 2500mm
- 3 mounting options; Welded Feet Wall Brackets & Cast Feet
- 3 week delivery for standard white RAL 9010
- 4 weeks for 188 RAL colours and 11 exclusive special finishes
- up to 50 factory welded sections
- 5 year guarantee

Choose the best combination of size, colour and mounting option for your room (see pages 55 - 59)

Ancona® from stock



- Available from stock
- 2, 3, & 4 column options
- 5 heights; 300mm, 500mm, 600mm, 750mm & 1800mm
- 3 mounting options; Slip on Welded Feet, Wall Brackets & Cast Feet
- 3-5 working days for white RAL 9010
- up to 40 pre-assembled sections, nipple & gasket joined
- 5 year guarantee

A range of popular sizes in white for fast delivery (see pages 60 - 62)

Sections

Steel multi column radiators are made up of sections, which allow greater flexibility especially when combined with column widths and multiple heights to deliver an exceptional choice of sizes.

Any heat output can be delivered by mixing and matching the three key elements of height, columns and sections.

Maximum 50 sections for Ancona made to order (2300mm) and 40 sections for Ancona sectional from stock (1840mm).

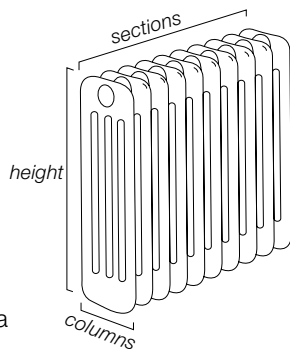

Mounting Options

Our steel multi columns can be mounted in one of three ways; for a contemporary look choose Welded Feet (slip on for stock Ancona®); for a classic look choose Cast Feet; or by specifying Wall Brackets you can position your steel multi column at any height.

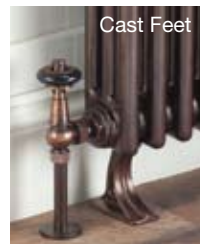

Matching Towel Rail & Bars



Traditional Ancona towel rail page 85

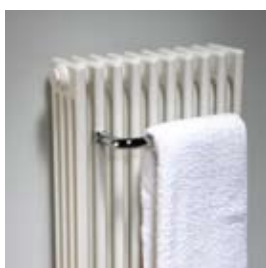

Ancona towel bar page 102

Valves

Complement your steel multi column radiator with any of our stunning range of valves. We recommend the ones pictured below for use with our Ancona range; see pages 91 to 100 for our full selection.



Buckingham TRV



Ideal TRV



Worcester



Vienna TRV

Ancona® made to order range

Our made to order range of Ancona steel multi column allows you the flexibility to create a radiator that matches your exact requirements. A vast array of sizes can be achieved by combining column depth, height and number of sections to achieve your desired output without compromising space; select a mounting option and add a colour or special finish to complement your interior style.

Columns

All made to order Ancona radiators can be specified in either 2, 3, 4, 5 or 6 column depths, this allows an increased output from a choice of radiators occupying the same wall surface area.

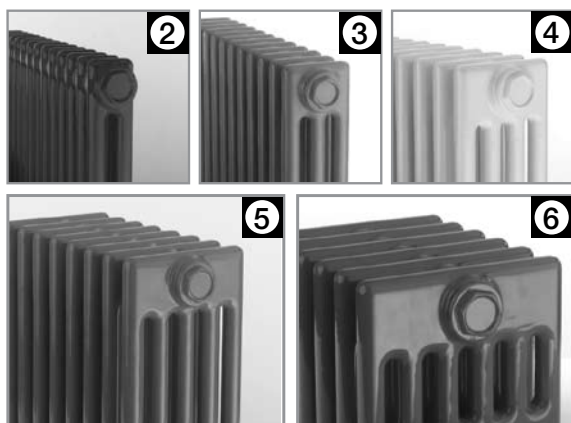

Heat Output

Knowing the heat output required (BTU/Watts) to heat your room is key when choosing your radiator. For help on calculating this and selecting the correct size of your chosen radiator please see page 160 or visit our website www.theradiatorcompany.co.uk.

Colours

Personalise your Ancona using a RAL colour or special finish; please specify your selection when you place your order.

 **188 RAL colours including white 9010 as standard plus 11 special finishes**

The complete Ancona range can be specified in one of the 188 RAL colours or any of the 11 exclusive special finishes including gun metal grey, textured white and ivory, mottled and antique finishes.



Call 01342 302250 for a RAL chart & samples of our special finishes.

Automatic Radiator Bleed Valve

The HV30 air vent is included with all suitable Steel Multi Column radiators: please refer to the Technical Section for inclusion.



Coloured Valves & Pipe Covers



We can match the colour of your valves, the pipe covers and pipe shrouds to your Ancona radiator in any one of the 188 RAL colours and 11 exclusive special finishes. See pages 96 - 97 for full details.

® Ancona is a registered trademark of The Radiator Company Limited

Ancona[®] + cast feet made to order

The Ancona with cast feet is also supplied with wall ties and the overall design is one of classic elegance; this model is the perfect alternative to a cast iron radiator.

Please specify cast feet when you place your order and remember to allow an extra 100mm to your height for cast feet.



Ancona with cast feet, 3 column, 25 sections, 600mm high, in Mottled Copper with Antique Copper Buckingham TRV valves



See page 85 for matching Traditional Ancona Towel Rail.

Product Information

Technical Details & Prices pages 135-137

Over 2000 combinations; 2, 3, 4, 5 & 6 column in 15 height options up to 20 sections. Outputs per section from 55 to 1375 Btu's. Please specify Cast Feet or Welded Feet when ordering your Ancona radiator.

Colours

Please call 01342 302250 for colour charts.

 Choose from 188 RAL colours & 11 special finishes (white 9010 as standard)

Available in the complete RAL range plus special colours including gun metal grey, textured and mottled finishes.

Delivery

Ancona + Cast Feet; 3 weeks for white 4 weeks for colours.

Ancona + Welded Feet; 4 weeks for white 5 weeks for colours.

For stocked range in white see pages 61 & 62

Ancona[®]

+ welded feet
made to order

The Ancona with welded feet gives this classic design a more contemporary style.

Remember to add an extra 105mm to your overall height



Ancona 3 column, 12 section, 1500mm high shown in exclusive finish Textured Ivory with TRC valves.

Ancona[®] bench seat made to order

The Ancona bench seat is perfect in boot rooms or in games rooms, providing a dual purpose solution. The Bench seat is provided with an open frame top so that you can match your finished seat to suit your interior scheme.



Ancona Bench Seat 6 Column, 388 x 1300, shown in RAL 9005 with example of black granite seat (not included).

Seat Ideas:

To complete the Ancona Bench Seat talk to your local supplier or contractor to select the most suitable material for your home. For example;



Product Information

Technical Details & Prices page 138

15 models in 3 heights and 5 widths
Outputs from 2852 to 8250 Btu's
Please note this radiator is provided with an open frame top and the seat must be purchased separately.

Colours

Please call 01342 302250 for colour charts.

 Choose from 188 RAL colours & 11 special finishes (white 9010 as standard)

Available in the complete RAL range plus special colours including gun metal grey, textured and mottled finishes.

Delivery

4 weeks for white
5 weeks for colours.

Ancona[®]

+ wall brackets
made to order

The Ancona with wall brackets is also supplied with wall ties so there is no need for floor support.



Ancona with wall brackets, 4 column, 10 sections, 1200mm high, in exclusive finish Textured White.

Product Information

Technical Details & Prices pages 135-137

Over 2000 combinations; 2, 3, 4, 5 & 6 column in 15 height options up to 20 sections. Outputs per section from 55 to 1375 Btu's Please specify Wall Brackets when ordering your Ancona radiator.

Colours

Please call **01342 302250** for colour charts.

 **Choose from 188 RAL colours & 11 special finishes (white 9010 as standard)**

Available in the complete RAL range plus special colours including gun metal grey, textured and mottled finishes.

Delivery

3 weeks for white
4 weeks for colours.

For stocked range in white see page 60.

Ancona[®] sectional + wall brackets stocked in white

Ancona sectional is our stocked range available for delivery in 3 - 5 working days. Please specify wall brackets or slip on welded feet when you place your order.



Ancona sectional with wall brackets, 3 column, 20 sections, 600mm high shown with Ideal TRV valves.



Adapt your Ancona for the bathroom with a towel bar, see page 102 for details.

Product Information

Technical Details & Prices pages 138-139

Over 500 combinations; 2, 3, & 4 column in 5 height options up to 40 sections. Outputs per section from 150 to 324 Btu's

Colour

White RAL 9010 only.

For made to order range colours & special finishes please see pages 57 & 59.

Delivery

3 - 5 working days

Ancona[®]
sectional
+ slip on welded feet
fast delivery in white

Remember to add an extra 80mm
to your overall height



Ancona with slip on welded feet, 3 column, 10 sections, 750mm high shown in RAL 9010 with Ideal TRV valves.

Ancona[®] sectional

+ cast feet
fast delivery in white

Please specify cast feet when you place your order and remember to allow an extra 100mm to your height for cast feet.



Ancona with cast feet, 2 column, 8 section, 1800mm high with Buckingham TRV valves.

Product Information

Technical Details & Prices pages 138-139

Over 500 combinations; 2, 3, & 4 column in 5 height options up to 40 sections. Outputs per section from 150 to 324 Btu's.

Colour

White RAL 9010 only.

For made to order range colours & special finishes please see page 56.

Delivery

3 - 5 working days

Traditional Cast Iron

The epitome of traditional heating, cast iron radiators are a must for any period restoration; suitable for living rooms, bedrooms, kitchens, hallways and dining rooms. Our choice of four classic designs offer the clean simplicity of “school house” or the decorative “classic ornate”. These radiators will be a perfect match for any existing radiators and being new, they come with a ten year guarantee.

As a material, cast iron has it’s own unique properties; these radiators will hold their heat for a long time, compared to a similar steel model, although they are slower to heat up and therefore less responsive to sudden changes in temperature.

Knowing the heat output required (BTU/Watts) to heat your room is key when choosing your radiator. For help on calculating this and selecting the correct size of your chosen radiator please see page 160 or visit our website www.theradiatorcompany.co.uk.

Design Styles

School house

Probably the most well known form of cast iron radiators, these are the original imported school house models; bringing a real charm and character to any period property.



Bianco



Ludlow

Classic ornate

The original detailed, ornate designs of the Vecchia and Trieste bring a touch of Georgian splendour to your home. The Vecchia is available in set sizes finished in RAL 6006 whilst the Trieste is sold by section and comes in a grey primer finish.



Vecchia



Trieste

Mounting Options

Cast iron radiators are very heavy and therefore best mounted on the floor. Bianco and Ludlow radiators can be wall mounted using our specialised wall brackets, as long as the wall is structurally strong enough to take the weight.

There are two methods of floor mounting; either footed end sections or individual feet. We offer two styles of feet; our standard Cast Foot or the Paw Foot, with its distinct lions paw design.

- Ludlow; available with footed end sections as standard, cast feet, paw feet or wall brackets.
- Bianco; available with cast feet as standard, paw feet or wall brackets.
- Vecchia; supplied with footed end sections only.
- Trieste; supplied with footed end sections only.



Solid Brass Valves

Our range of valves include the classically styled Black & Brass models in both Manual and Thermostatic versions and a range of solid brass valves, manufactured in the UK. A perfect match for cast iron radiators, these hand finished solid brass valves complement the range of classic cast iron designs with traditional styling and quality components. See pages 91 - 100 for details.



TRC Valve



Buckingham TRV

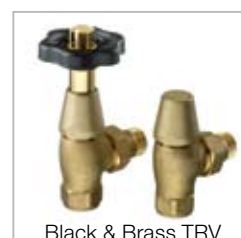

Black & Brass TRV

Bianco

This all time classic is the traditional choice and retains its popular character and charm. The Bianco comes with cast feet as standard but is also available with optional paw feet or wall brackets.



Bianco 4 column 9 sections 571mm high, painted with standard radiator paint, shown with Chrome TRC valves and cast feet.



Optional Paw Foot with Vienna TRV valve.

Product Information

Technical Details & Prices pages 140-141

Over 45 combinations; 3 height options in 4 or 6 column in up to 10 sections.
Outputs per section from 271 to 580 Btu's.

Colours

Available in white primer finish only, ready to be painted in your desired finish.

Delivery

3 - 5 working days

Please see technical section on page 140 before ordering.
Supplied pre-assembled up to 10 sections; longer radiators must be joined onsite.

Ludlow

The Ludlow School House design has a crisp, square profile and is available with the added benefit of a footed end section as well being suitable for use with cast feet, paw feet or wall brackets.



Ludlow 4 column, 10 section, 748mm high painted with standard radiator paint with Buckingham TRV valves with standard footed end sections.

Optional Paw Foot with Vienna valve.

Product Information

Technical Details & Prices pages 140-141

Over 90 combinations; 6 heights in 4 or 6 column up to 10 sections.
Outputs per section from 147 to 474 Btu's.

Colours

Available in white primer finish only, ready to be painted in your desired finish.

Delivery

3 - 5 working days

Please see technical section on page 140 before ordering.

Supplied pre-assembled up to 10 sections; longer radiators must be joined onsite.

Vecchia

The Vecchia is a beautifully designed ornate cast iron radiator and is available in three sizes with footed end sections.

BOE connections (Bottom Opposite Ends) as standard, but can be specified as TBSE (Top and Bottom Same End) at time of order.



Vecchia 8 section 838 x 615, shown with Buckingham TRV valves.

Product Information

Technical Details & Prices page 142

3 models;
1 height & 3 widths.
Outputs from 2946 to 4907 Btu's

Colours

Available in grey RAL 6006 only.

Please call **01342 302250** for colour charts.

Delivery

3 - 5 working days

Please see technical section on page 140 before ordering.

Trieste

Sold by section this classically ornate radiator features detailed engraved ears, 2 or 3 columns with footed end sections.



Trieste 2 column profile.

Trieste 3 column 10 sections, 800mm high painted in standard radiator paint with Vienna TRV valves.

Product Information

Technical Details & Prices page 142

Over 25 combinations; 2 heights in 2 or 3 column in up to 10 sections.
Outputs per section from 444 to 754 Btu's.

Colours

Available in grey RAL 7022 primer finish only, ready to be painted in your desired finish.

Delivery

3 - 5 working days

Please see technical section on page 140 before ordering.
Supplied pre-assembled up to 10 sections; longer radiators must be joined onsite.

Bathroom Towel Rails

Automatic Radiator Bleed Valve

The HV30, air vent is included with all suitable Towel Rails: please refer to the Technical Section for inclusion.



With space often at a premium, a towel rail functions as both a heat source and as a towel warmer; perfect for bathrooms, kitchens and cloakrooms (Please note; Towel Rails are not designed to dry soaking wet clothes or towels as this can lead to rusting of the rail).

Italian Design & Manufacture

Italy has earned a worldwide reputation for being at the leading edge of radiator design; style and practical functionality has produced a whole host of iconic products. We work with some of the best Italian radiator designers and manufacturers to bring you a wide choice of stylish, quality products.

Designer Towel Rails

Stunning and practical designs, complementing our designer range.

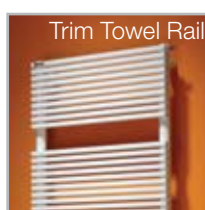

Stainless Steel Towel Rails

These high design towel rails are available in three different styles.



Classic Towel Rails

These solid brass towel rails are stylish classics



Many of our towel rails can be converted to dual application by adding an electrical element; this allows the rail to warm towels during the summer when the main heating system is switched off.

Colours

Personalise your radiator using a RAL colour or special finish. You can select your preferred colour from the Colour Group associated with your chosen radiator; please specify your selection when you place your order. The Colour Groups for towel rails are:

1 25 RAL colours (white 9010 as standard) plus 14 special finishes
 1001 1013 1015 1016 1021 2003 3000
 3003 3015 5002 5012 5014 5017 6019
 6027 7016 7035 7042 8011 9001 9005
 9006 9007 9010 9011

2 17 RAL colours including white 9010 as standard plus 7 special finishes
 1013 1015 1021 3000 3002 3003 3004
 5014 5021 6016 7016 7035 9005 9006
 9007 9010 9011

10 188 RAL colours including white 9003 as standard plus 8 special finishes
 Available in the complete RAL range plus 8 special finishes.

9 All 188 RAL colours plus 11 special finishes
 Available in the complete RAL range, plus additional special colours including gun metal grey, textured white & ivory, mottled & antique finishes.

For a copy of the RAL colour chart and samples of the special finishes available with your selection call 01342 302250.

Valves & Accessories

Choose from our comprehensive range of high quality valves to suit any towel rail. We recommend the valves pictured right; see pages 91 to 100 for our full range.



Add practical hooks and bars for extra hanging space. See page 102 for more information.



Ice Bagno



Polished Stainless Steel full bars.



Matt White with short bars

Ice Bagno horizontal in Matt White

The Ice Bagno towel rails are part of the Ice Range (see pages 8 & 9); available in both a horizontal and vertical configuration, on vertical options full towel bars come as standard, short bars are available on request.

Product Information

Technical Details & Prices page 143

2 horizontal models & 6 vertical models
Outputs from 1365 to 2707 Btu's
Optional B2 connections available.

Colours

Polished Stainless Steel or Matt White

Please call **01342 302250** for colour charts.

Delivery

6 weeks for Matt White
8 weeks for Polished Stainless Steel

Volcano Towel Rail

The Volcano Towel Rail gives incredible outputs for your bathroom, making it ideal for larger spaces.

Product Information

Technical Details & Prices page 143

12 models;
Outputs from 1433 to 5120 Btu's
Suitable for dual application

Colours

Available in white RAL 9010 as standard plus colour group **9**, see page **68** for full details.

Delivery

3 - 5 working days for stock white

6 weeks for non stock white & colours.



Volcano Towel Rail 1160 x 586, shown in RAL 9010.

180 A

Short on wall space? Look no further than the 180 A. At just 340mm wide this is our narrowest towel rail.

Product Information

Technical Details & Prices page 144

4 models;
Outputs from 867 to 1696 Btu's
Suitable for dual application

Colours

Available in white RAL 9003 as standard plus colour group **10** and chrome, see page **68** for full details.

Delivery

3 - 5 working days for white & chrome

4 weeks for colours.



180 A 1250 x 340, shown in Chrome.

BDO Trim

If you have the space the BDO Trim is a practical and stylish solution with plenty of space for large towels.



BDO Trim 368 x 1200 shown in ARR.G.

Product Information

Technical Details & Prices page 144

6 models.
Outputs from 1823 to 3645 Btu's.
Suitable for dual application.

Colours

Available in white RAL 9010 as standard plus colour group **1**, see page **68** for full details.

Delivery

6 weeks for white,
6 weeks for colours.

Tornado Towel Rail

The Tornado Towel Rail brings the 68mm patented flat tube to the bathroom.

Product Information

Technical Details & Prices page 144

12 models;
Outputs from 1935 to 5775 Btu's
Suitable for dual application

Colours

Available in white RAL 9010 as standard plus colour group **9**, see page **68** for full details.

Delivery

3 - 5 working days for stock white

6 weeks for non stock white & colours.



Tornado Towel Rail 1125 x 586 in white RAL 9010 shown with Cylinder valves.

Trim Towel Rail

This Towel Rail has sleek rectangular cross tubes providing good output.

Product Information

Technical Details & Prices page 145

12 models;
Outputs from 1785 to 5495 Btu's
Suitable for dual application

Colours

Available in white RAL 9010 as standard plus colour group **1**, see page **68** for full details.

Delivery

3 - 5 working days for stock white

6 weeks for non stock white & colours.



Trim Towel Rail 1520 x 500 shown in RAL 9010, with Minimalist valves.

BDO 25

Lots of hanging space and strong outputs, the BDO 25 is a welcome addition to the TRC 25 range.



BDO 25 584 x 1400 shown in RAL 9010.

Product Information

Technical Details & Prices page 145

6 models.
Outputs from 1635 to 3270 Btu's.
Suitable for dual application.

Colours

Available in white RAL 9010 as standard plus colour group 1, see page 68 for full details.

Delivery

3 - 5 working days for stock white

4 weeks for non stock white,
6 week for colours.



Bath 25 1160 x 485, shown in RAL 9010 with 3 Style valves.

Bath 25 NEW

Using a 25mm tube on tube design, this is a solid, practical and attractive towel rail.

Product Information

Technical Details & Prices page 145

12 models
Outputs from 1294 to 3744 Btu's
Suitable for dual application

Colours

Available in white RAL 9010 only.

Delivery

3 - 5 working days for stock white

BD 13

The BD 13 is available in either a single or double configuration for a wide range of outputs, the single can also be chromed.

Product Information

Technical Details & Prices page 146

27 models in singles and doubles
Outputs from 886 to 5129 Btu's
Suitable for dual application.

Colours

Available in white RAL 9010 as standard plus colour group **1** & chrome, see page **68** for full details.

Delivery

4 weeks for white,
6 weeks for colours,
8 weeks for chrome.



BD 13 1520 x 500, shown in METT.

Dexter

The ultra slim Dexter features flat cross tubes with a subtle curving profile that continues through to the angled collectors.



Dexter 1220 x 400, shown in Matt Silver.

Product Information

Technical Details & Prices page 146

15 models
Outputs from 918 to 3294 Btu's.
Suitable for dual application.

Colours

Available in white RAL 9003 as standard plus colour group **10** and chrome, see page **68** for full details.

Delivery

3 - 5 working days for stock lines

4 weeks for non stock white & colours.
7 weeks for non stock chrome.

Poll Range

The Poll is one of our most popular ranges, with high outputs and practical extended towel bars they provide excellent value.



Poll Chrome 1055 x 700.



Poll Kitchen (electric)

Product Information - Poll Kitchen

Technical Details & Prices page 147

Poll Kitchen; 1 electric model.

Colours

Available in white RAL 9003, Matt Silver or Matt Black.
Please call **01342 302250** for colour charts.

Delivery

3 - 5 working days for all finishes.



Poll Kitchen 230 x 450, shown in Matt Silver



Poll 1055 x 450, shown in RAL 9003.

Product Information

Technical Details & Prices page 147

Poll; 14 models

Poll Chrome; 9 models

Outputs from 509 to 4683 Btu's.

Suitable for dual application.

Colours

Available in white RAL 9003 as standard, chrome, plus colour group **10**, see page **68** for full details.

Delivery

3 - 5 working days for stock lines

4 weeks for colours.

Lupin

The Lupin is a classic bathroom ladder rail and is available from stock in white and chrome.



Lupin white 1300 x 500 shown with Standard valves.



Lupin chrome 950 x 400.

Product Information

Technical Details & Prices page 148

24 models; outputs from 976 to 3702 Btu's
Suitable for dual application

Colours

White RAL 9010 or Chrome

Please call **01342 302250** for colour charts.

Delivery

3 - 5 working days for stock

Poppy

With a gentle curved profile, the Poppy is our most popular ladder rail. Available from stock in white and chrome.



Poppy white 1650 x 500



Poppy chrome 1300 x 600 shown with Cylinder valves.

Product Information

Technical Details & Prices pages 148-149

24 models; outputs from 1018 to 3821 Btu's
Suitable for dual application

Colours

White RAL 9010 or Chrome

Please call **01342 302250** for colour charts.

Delivery

3 - 5 working days for stock

Picchio Towel Rail

The Picchio Towel Rail offers a stunning alternative to the usual ladder rails.

Product Information

Technical Details & Prices page 149

15 models
Outputs from 1089 to 4526 Btu's
Suitable for dual application

Colours

Available in white RAL 9010 as standard plus colour group **2** and chrome, see page **68** for full details.

Delivery

3 - 5 working days for stock lines

4 weeks for non stock white
6 weeks for colours & non stock chrome.



Picchio Towel Rail 1201 x 510 shown in Chrome with 3 Style valves.

Camino Towel Rail

The Camino Towel Rail is available in a wide range of widths and heights.

Product Information

Technical Details & Prices page 150

10 models
Outputs from 1567 to 4843 Btu's
Suitable for dual application

Colours

Available in white RAL 9010 as standard plus colour group **2**, see page **68** for full details.

Delivery

3 - 5 working days for stock lines

4 weeks for non stock white,
6 weeks for colours.



Camino Towel Rail 1207 x 510 shown in RAL 9010 with 3 Style valves.

Iris

The Iris is a practical towel rail constructed from polished stainless steel and is available from stock in four popular sizes.



Iris 1295 x 520, shown with 3 Style valves.



Iris 810 x 1000.

Product Information

Technical Details & Prices page 150

4 models: outputs from 1552 to 2183 Btu's
Suitable for direct & dual application system.

Colours

Polished Stainless Steel.

Delivery

3 - 5 working days



Sail 700 x 650, shown in Polished Stainless Steel.

Sail

The Sail presents an eye-catching high-design shape with the benefits of stainless steel construction and finish.

Product Information

Technical Details & Prices page 150

2 models
Outputs from 1263 to 1792 Btu's
Suitable for dual application & a direct system

Colours

Polished or Brushed Stainless Steel.

Delivery

3 - 5 working days

Mast

Pleasing to the eye, the Mast is an attractive variation to the traditional towel rail design.

Product Information

Technical Details & Prices page 151

2 models
Outputs from 1263 to 1792 Btu's
Suitable for dual application & a direct system

Colours

Polished or Brushed Stainless Steel.

Delivery

3 - 5 working days



Mast 1200 x 500, shown in Polished Stainless Steel.

Sudbury

Made from brass tubes with a 3 column sectional steel radiator, this traditionally styled chrome finish towel rail comes in two sizes.

Product Information

Technical Details & Prices page 151

2 models
Outputs from 1362 to 1918 Btu's

Colours

Chrome with White RAL 9010 sections

Delivery

3 - 5 working days



Sudbury 950 x 500 shown with Chrome Crosshead valves.



York 1500 x 585 with Chrome Crosshead valves.

York

The sectional steel radiator provides strong output on this tall, classic, towel rail.

Product Information

Technical Details & Prices page 151

1 model available
Output 2669 Btu's

Colours

Chrome with White RAL 9010 sections

Delivery

3 - 5 working days

Chester

The Chester's contemporary tubular design continues through to the integral valves.

Product Information

Technical Details & Prices page 151

3 models; outputs from 1007 to 1751 Btu's
Suitable for a direct system, integral valves.

Colours

Old Copper

Pewter

Chrome



Oil Rubbed
Bronze

Polished
Brass

Brushed
Nickel

Antique
Bronze



Please call **01342 302250** for colour samples.

Delivery

4 weeks for Chrome,
5 weeks for all other finishes.



Chester 1076 x 530, shown in Chrome.

Arundel

An additional top rail and integral valves add to the appeal of this traditional styled towel rail.

Product Information

Technical Details & Prices page 152

1 model; output 1544 Btu's
Supplied with integral valves and is suitable
for a direct system, floor connections only.

Colours

Polished Brass

Chrome

Brushed Nickel



Please call **01342 302250** for colour samples.

Delivery

3 - 5 working days for Chrome

5 weeks for Polished Brass & Brushed Nickel



Arundel 1042 x 600 shown in Chrome, with integral valves.

Traditional Ancona

A stunning combination of solid 32mm brass collectors & an Ancona steel radiator, provides traditional style with exceptional output.



Traditional Ancona 972 x 600 shown in Chrome, with integral valves.



Traditional Ancona in Antique Bronze with sections in Textured Ivory.

Product Information

Technical Details & Prices page 152

1 model
Output; 2233 Btu's.
Floor connections only, the Traditional Ancona is supplied with integral valves.

Colours

Chrome Antique Bronze Brushed Nickel



Please call **01342 302250** for colour samples.

Delivery

3 - 5 working days for Chrome

5 weeks for Antique Bronze & Brushed Nickel

Panorama

The Panorama is a solid brass towel rail available in three finishes.

Product Information

Technical Details & Prices page 152

1 model
Output 1501 Btu's
Suitable for dual application

Colours

Chrome Pewter Brushed Nickel



Please call **01342 302250** for colour samples.

Delivery

3 - 5 working days for stock Chrome

5 weeks for Pewter & Brushed Nickel



Panorama 440 x 1220 shown in Chrome, with integral valves.

Cambridge

This solid brass towel warmer features a fold down shelf for extra storage space.

Product Information

Technical Details & Prices page 152

3 models
Outputs from 1099 to 1298 Btu's
Suitable for dual application

Colours

Chrome



Please call **01342 302250**
for colour sample.

Delivery

3 - 5 working days for stock Chrome

4 weeks for non stock Chrome.



Cambridge 1135 x 500 shown in Chrome, with integral valves.

Convector introduction

Convector radiators have unique qualities that allow them to fulfil specific roles within the home. The term convector relates to their use of air movement to circulate heated air around a room. Aluminium fins are heated by hot water piped in via the usual copper pipes and as the air is heated it rises and cold air is drawn in. This movement allows a small unit to have a high heat output and be very space efficient.

TRC Skirting Heating

TRC Skirting heating is the solution where wall space is at a premium. Extremely durable and easy to install it is supplied from stock in four possible lengths - 500mm, 1000mm, 1500mm and 2000mm.



Skirting, shown in Textured White RAL 9010.

Product Information

Technical Details & Prices page 153

4 width options; variety of corners & end caps
Outputs from 956 to 3827 Btu's.
Please see technical section on page 153
before ordering.

Colours

Textured White RAL 9010

Delivery

3 - 5 working days



Mini 200 x 600 x 130, shown in RAL 9010.

Mini

The Mini is a robust and practical product which is floor mounted, so it can be placed almost anywhere and is particularly suitable for positioning alongside glass.

Product Information

Technical Details & Prices pages 154-155

Over 80 models; 4 depths & 2 heights
Outputs from 1314 to 15304 Btu's

Colours

5 188 RAL colours including white
9010 as standard)

Available in the complete RAL range.

Please call **01342 302250** for colour charts.

Delivery

4 weeks.

Plinth

electric & hydronic

The Plinth is an excellent space saving alternative to either radiators or under floor heating.

Product Information

Technical Details & Prices page 157

2 models; 1 electric & 1 hydraulic option.

Colours

Supplied as a white facia as standard plus an additional slip on brushed steel cover.

Delivery

3 - 5 working days



Plinth, hydronic with White facia.

LST

Our LST (Low Surface Temperature) has been designed so that it is not only simple to install in 6 easy steps, but also conforms to the latest UK standards and is BSRIA performance tested in accordance with NHS guidelines.



LST 600mm x 800mm x 125mm, shown in white with standard Herz TRV valve.



Performance Tested by BSRIA in accordance with BS EN442 and assessed against requirements in NHS Estates Health Guidance Note "Safe hot water and surface temperatures" 1998.

Product Information

Technical Details & Prices pages 156 - 157

36 models; 2 depths & 3 heights, other sizes available on request.
Outputs from 1744 to 12137 Btu's

Colours

White RAL 9010 only

Delivery

4 weeks.



optional bottom left standard Herz TRV valve

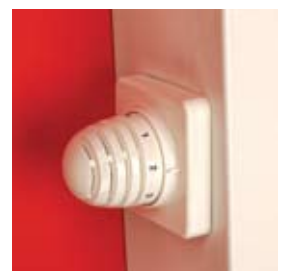

optional top left or right remote adjustment valve



optional pencil proof grille



optional Hercules tamper proof valve

Trench

The Trench is a practical alternative to underfloor heating, requiring no wall space and giving excellent heat output.



Trench shown with Beech grille.

Choice of grilles in either painted aluminium or various woods. For samples please call us on 01342 302250.

- White Aluminium
- Black Aluminium
- Bronze Aluminium
- Silver Aluminium
- Ash Untreated
- Ash Varnished
- Beech Untreated
- Beech Varnished
- Oak Untreated
- Oak Varnished
- Merbau Untreated
- Merbau Varnished



Trench shown with Oak grille.

Product Information

Technical Details & Prices pages 158-159

Over 80 models; 3 depths and 9 lengths
Outputs from 1331 to 17826 Btu's.

Colours

Grille can be of various woods or coloured aluminium. Please choose from the available list on the left.

Delivery

4 weeks.

Valves introduction

High quality radiators deserve high quality valves for efficient performance and they influence the whole appearance of your finished radiator.

Finishes and Colours;

A wide range of standard finishes are available from stock; in addition selected valves can be painted to match radiators ordered from colour group 9; see page 96.



Wheel head and Lockshield;

Radiators require two valves which work together as a pair. The Wheelhead is used to adjust the flow of water into each radiator and the Lockshield maintains a balanced flow of water around the whole system, ensuring each radiator receives the correct rate of flow in order to heat up; these will be adjusted by your installer when balancing your system. All our valves are priced as pairs.

TRV or Manual?

Manual valves are adjusted by hand; they will allow a constant flow of water through your radiator regardless of the room temperature and radiators will only turn off when the room thermostat (usually in the hall) reaches it's set point or the programmer turns the heating off. Systems may have at least two manual valves included, on a radiator that acts as a bypass for the system (usually a towel rail) and one in the same area as the room thermostat so they do not conflict with each other.

Thermostatic Radiator Valves (TRVs) monitor the ambient room temperature with a built in thermostat. They usually have between 4 to 6 set levels which you can select and the valve then opens and closes automatically to reach and maintain the desired level. If one room reaches the set temperature the radiator will effectively turn off whilst others continue to operate. TRVs can help maximise the efficiency of your system reducing energy consumption and they are now a requirement as part of building regulations relating to new builds and refurbishments.

Angled or Straight?

The choice of which format of valve to use will depend on the location of your pipe work and the position of the collectors on the radiator. The pictures opposite show how different configurations work;

- A) Angled from wall
- B) Angled from floor
- C) Straight from floor
- D) 3 Style on towel rail note how the heads are tucked neatly in line with the towel rail

If you are planning to move your radiators or change from horizontal to vertical you should discuss the amount of work involved with your installer and plan how to keep exposed pipe work to a minimum.

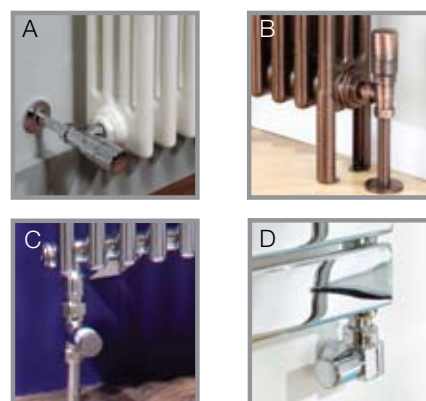

Pipe work;

There are a variety of different pipe sizes and materials used for heating systems in the UK; 15mm, 22mm, 28mm, in copper, plastic, iron or chrome. It is important to discuss with your installer the type of pipe work being used to ensure your valves are specified correctly.

The most common size of pipe in the UK is 15mm (also known as 1/2"); often 22mm (or 3/4") pipe work is used on large or older systems with cast iron radiators. All our valves have 15mm connections as standard unless otherwise stated; if you need different connections please specify when ordering your valves.

Most pipes will be made from copper and all our valves work with this material. On older houses iron pipe work may still exist (usually 22mm 3/4"); you will need to specify this to ensure your valve connections are the correct size.

Over recent years push fit plastic pipe has become more popular and some plumbers may wish to directly connect the plastic pipe to the valve but our valves are not designed to operate with plastic pipes.

In some cases chrome pipe work is used to supply water to the radiator; because chrome is a harder surface than copper or iron most valves will not grip it securely and leaks can occur; special olives are required to enable valves to grip chrome pipe work and these must be specified at time of order, please contact us on 01342 302250 if you would like more information.

Pipe centres;

The location of the pipe work for your radiator will be affected by the size of valves you select. All angled valves have a dimension shown to allow for adjusting pipe work. If you are planning to fix pipe work before receiving your radiators you should make adequate allowances for manufacturing tolerances in pipe centres.

If you are using straight valves a minimum of 150mm should be allowed from the base of the radiator for ease of installation.

Please Note: We endeavour to ensure all pipe centres are correct, however manufacturing tolerances must be considered; therefore we strongly recommend that pipe work is not altered or adjusted until the new radiator or towel rail is fitted. The Radiator Company will not accept any responsibility for claims resulting from incorrect pipe centres.

Thermostatic Valves

All stocked valves have prices listed in purple and will be delivered in 3 - 5 working days.

Deluxe TRV

The Deluxe TRV is available in white, chrome or black in angled or straight options.



Chrome



White



Black Straight



Black Angled Wheelhead & Lockshield

Pipe Centers For angled valves allow an extra 120mm in total	Valve Height 140mm	Please Note Deluxe TRV valves are not Bi-directional
--	------------------------------	--

Model	Description	White Ex VAT	Chrome Ex VAT	Black Ex VAT	White Inc VAT	Chrome Inc VAT	Black Inc VAT
WDELTRV	Angled or Straight	£159.00	£159.00	£159.00	£190.80	£190.80	£190.80

Simple TRV NEW



Chrome Angled



White Angled Wheelhead & Lockshield

Pipe Centers For angled valves allow an extra 80mm in total	Valve Height 120mm (based on closed valves)	Please Note Simple TRV valves are not Bi-directional
---	---	--

Model	Description	White Ex VAT	Chrome Ex VAT	White Inc VAT	Chrome Inc VAT
VSIMTRV	Angled or Straight	£65.00	£65.00	£78.00	£78.00

Corner Ideal TRV NEW



Chrome Angled Wheelhead & Lockshield



White



Nickel

Pipe Centers For angled valves allow an extra 76mm in total	Valve Height 116mm	Please Note Corner Ideal TRV valves are not Bi-directional
---	------------------------------	--

Model	Description	White Ex VAT	Chrome Ex VAT	Nickel Ex VAT	White Inc VAT	Chrome Inc VAT	Nickel Inc VAT
WCOIDTRV	Angled only	£99.00	£99.00	£140.00	£118.80	£118.80	£168.00

Thermostatic Valves

All stocked valves have prices listed in purple and will be delivered in 3 - 5 working days.

Ideal TRV shown on pages 30, 39, 48, 51, 53, 61.

Available in six finishes, in angled or straight options, the Ideal TRV is a great value Thermostatic valve.



Straight Nickel



Nickel Angled Wheelhead & Lockshield

Pipe Centers For angled valves allow an extra 80mm in total	Valve Height 125mm	Please Note Ideal TRV valves are not Bi-directional
---	------------------------------	---



Chrome



Antique Copper



White



Antique Brass



Black

Please note: all valves are sold in pairs, a lockshield and a wheelhead.

Model	Description	Chrome Ex VAT	Nickel Ex VAT	White Ex VAT	Black Ex VAT	Antique Copper Ex VAT	Antique Brass Ex VAT
WIDETRV	Angled or Straight	£97.00	£121.00	£97.00	£121.00	£121.00	£121.00
Model	Description	Chrome Inc VAT	Nickel Inc VAT	White Inc VAT	Black Inc VAT	Antique Copper Inc VAT	Antique Brass Inc VAT
WIDETRV	Angled or Straight	£116.40	£145.20	£116.40	£145.20	£145.20	£145.20

Solid Brass Valves

All stocked valves have prices listed in purple and will be delivered in 3 - 5 working days.

Quality speaks for itself and our range of British made brass valves are no exception. Hand finished and made from solid brass, these valves are beautifully engineered; they are the perfect complement to Ancona and Cast Iron radiators.



TRC in Antique Brass

Due to the nature of hand finishing and colour printing, colours may vary from that shown and between individual valves.

Please Note: All our solid brass valves are bi-directional, however we strongly recommend the wheelhead is placed on the flow side.

Matching solid brass Telescopic Pipe Covers and Shrouds are available; see page 101 for details on finishes and prices.



Telescopic Pipe Cover & Shroud in Chrome

Buckingham TRV made to order

For a neater finish Buckingham valves are now available in a selection of handed return angled and straight valve options. Made to order the special return angle valves are the same price as the standard models (prices can be found at the bottom of page 95) however you will need to allow 3 weeks for delivery.



Antique Brass Straight wheelhead



Satin Nickel Angled left wheelhead



Satin Nickel Angled left lockshield

Return angled valves are left and right handed, you can select the correct option by identifying which side of the radiator has the flow connection; e.g flow connection on the left side requires a left hand wheel head and matching lockshield.



Left hand return angled valve with matching pipe cover & shroud.

Please specify, straight or return angled valves (stating left or right hand return for the wheel head if ordering the return angle valves), delivery will be in 3 weeks. See bottom of page 95 for prices.

Worcester



Satin Nickel



Antique Copper



Brass



Antique Brass



Chrome Angled Wheelhead & Lockshield

TRC Valve shown on pages 57 & 64



Satin Nickel



Brass



Chrome



Antique Brass Angled Wheelhead & Lockshield

Pipe Centers	Valve Height	Please Note
For angled valves allow an extra 90mm in total	110mm	This valve is bi-directional; please see note on page 94

Model	Description	Brass Ex VAT	Chrome Ex VAT	Satin Nickel Ex VAT	Antique Copper Ex VAT	Antique Brass Ex VAT
VWORCAN	Angled	£206.00	£217.00	£217.00	£248.00	£248.00
Model	Description	Brass Inc VAT	Chrome Inc VAT	Satin Nickel Inc VAT	Antique Copper Inc VAT	Antique Brass Inc VAT
VWORCAN	Angled	£206.00	£217.00	£217.00	£248.00	£248.00

Pipe Centers	Valve Height	Please Note
For angled valves allow an extra 90mm in total	115mm	This valve is bi-directional; please see note on page 94

Model	Description	Brass Ex VAT	Chrome Ex VAT	Antique Brass Ex VAT	Satin Nickel Ex VAT
WTRC	Angled	£189.00	£206.00	£206.00	£206.00
Model	Description	Brass Inc VAT	Chrome Inc VAT	Antique Brass Inc VAT	Satin Nickel Inc VAT
WTRC	Angled	£226.80	£247.20	£247.20	£247.20

Solid Brass Valves

All stocked valves have prices listed in purple and will be delivered in 3 - 5 working days.

Buckingham TRV

shown on pages 56, 62, 65 & 66.

The Buckingham TRV valves are scale replicas of original 1920's designs, a triumph of British engineering.

These valves are now available in a selection of handed return angled and straight valve options; see opposite for more details.



Chrome Angled Wheelhead & Lockshield

Pipe Centers For angled valves allow an extra 90mm in total.	Valve Height 135mm	Please Note This valve is bi-directional; please see note on page 94
--	------------------------------	--



Brass



Antique Copper



Satin Nickel



Antique Brass

Model	Description	Brass Ex VAT	Chrome Ex VAT	Satin Nickel Ex VAT	Antique Copper Ex VAT	Antique Brass Ex VAT	Brass Inc VAT	Chrome Inc VAT	Satin Nickel Inc VAT	Antique Copper Inc VAT	Antique Brass Inc VAT
WBUCTRVANW	Angled Walnut top	£231.00	£253.00	£253.00	£253.00	£253.00	£277.20	£303.60	£303.60	£303.60	£303.60
WBUCTRVANB	Angled Black Walnut top	£231.00	£253.00	£253.00	£253.00	£253.00	£277.20	£303.60	£303.60	£303.60	£303.60

Please Note: Made to order straight & return angled options have a delivery time of 3 weeks; see page 94 for more details.

All stocked valves have prices listed in purple and will be delivered in 3 - 5 working days.

Painted Valves & Pipe Covers

Exclusive to the Ancona, Volcano, Volcano Cubed and Tornado radiators and their towel rails, you have the option to fully coordinate your radiator colour with your valves and pipe covers to create a unique and individual statement.

The following range of valves can be painted in the same colour as your radiator from any of the 188 RAL options plus 11 exclusive special finishes available, *when ordered at the same time as the radiator or towel rail required and in the same colour.*

To provide complete coordination, simply follow these four easy steps:



1. Select your valve;
Minimalist, Cube,
Crosshead or Cylinder.
 (see page 97)



2. Select your colour from colour group 9.



188 RAL colours plus 11 exclusive special finishes

The 11 additional exclusive special finishes include gun metal grey, textured white and ivory, mottled copper, mottled silver, textured black and dark grey, RAL 9006 and RAL 9007, see page 55 for more information. Please call 01342 302250 for RAL and Special Finish charts.



3. Select matching pipe covers and shrouds.

We can also match the colour of the pipe covers and pipe shrouds for your Ancona, Tornado and Volcano radiators in any one of group 9 colour options shown above. Each pair of painted pipe covers comes with matching shrouds (See picture right).



4. Order your matching valves and pipe covers at the same time you order your radiator

Painted Valves.

Model	Description	Colours Ex VAT	Colours Inc VAT
VVMIN	Minimalist angled or straight	£229.00	£274.80
WCRO	Crosshead angled or straight	£197.00	£236.40
WCUB	Cube angled or straight	£250.00	£300.00
WCYL	Cylinder angled or straight	£134.00	£160.80

Delivery time 4 weeks

Please specify angled or straight, as well as the RAL colour or special finish at time of order.

Painted Pipe covers and shrouds

Model	Description	Chrome Ex VAT	Colour Ex VAT	Chrome Inc. VAT	Colour Inc VAT
AAPIPECOV	Pipe covers	£34.00	£54.00	£40.80	£64.80

Each set is supplied with 2 x 160mm pipe covers and 2 shrouds. Delivery on coloured pipe covers is 4 weeks; chrome are held in stock.

For pipe centre information for these valves please refer to opposite page.

All stocked valves have prices listed in purple and will be delivered in 3 - 5 working days.

Cylinder

shown on pages 8, 15, 24, 28, 38 & 79



Pipe Centers For angled valves allow an extra 80mm in total	Valve Height 85mm	Please Note Cylinder valves are not Bi-directional
---	-----------------------------	--

Model	Description	White Ex VAT	Chrome Ex VAT	Nickel Ex VAT
WCYL	Angled or straight	£70.00	£70.00	£85.00
Model	Description	White Inc VAT	Chrome Inc VAT	Nickel Inc VAT
WCYL	Angled or straight	£84.00	£84.00	£102.00

This valve can be painted in any colour from Colour Group 9 see page 96 for details.

Minimalist

shown on page 72

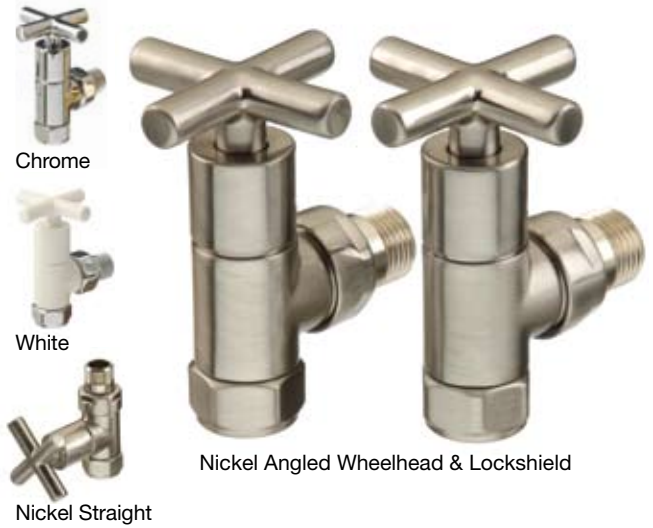

Pipe Centers For angled valves allow an extra 80mm in total	Valve Height 96mm	Please Note Minimalist valves are not Bi-directional
---	-----------------------------	--

Model	Description	White Ex VAT	Chrome Ex VAT	Nickel Ex VAT
VVMIN	Angled or straight	£139.00	£139.00	£172.00
Model	Description	White Inc VAT	Chrome Inc VAT	Nickel Inc VAT
VVMIN	Angled or straight	£166.80	£166.80	£206.40

This valve can be painted in any colour from Colour Group 9 see page 96 for details.

Crosshead

shown on page 83



Pipe Centers For angled valves allow an extra 80mm in total	Valve Height 110mm	Please Note Crosshead valves are not Bi-directional
---	------------------------------	---

Model	Description	Chrome Ex VAT	Antique Copper Ex VAT	Nickel Ex VAT
WCRO	Angled or straight	£112.00	£148.00	£174.00
Model	Description	Chrome Inc VAT	Antique Copper Inc VAT	Nickel Inc VAT
WCRO	Angled or straight	£134.40	£177.60	£208.80

This valve can be painted in any colour from Colour Group 9 see page 96 for details.

Cube

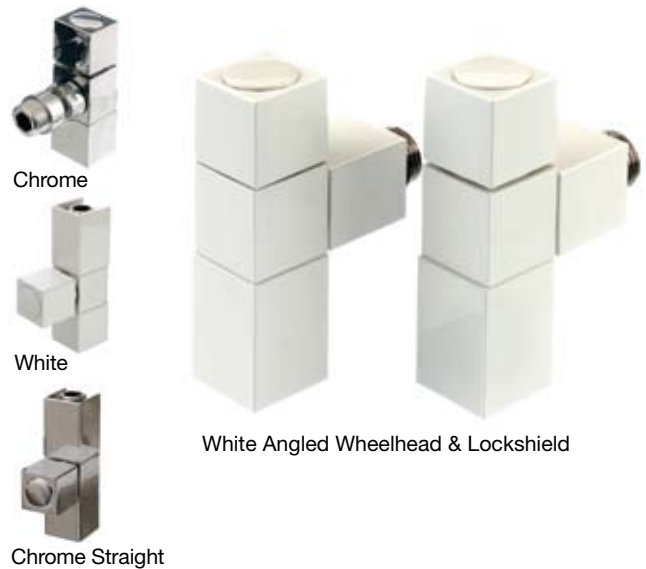

Pipe Centers For angled valves allow an extra 100mm in total	Valve Height 112mm	Please Note Cube valves are not Bi-directional
--	------------------------------	--

Model	Description	White Ex VAT	Chrome Ex VAT	White Inc VAT	Chrome Inc VAT
WCUB	Angled or straight	£163.00	£167.00	£195.60	£200.40

This valve can be painted in any colour from Colour Group 9 see page 96 for details.

All stocked valves have prices listed in purple and will be delivered in 3 - 5 working days.

Mini Cube shown on pages 31, 37, 49 & 50.

A smaller version of our popular Cube valves.



Cube & Mini Cube shown side by side to show size difference.

Chrome



Nickel Angled Wheelhead & Lockshield

Pipe Centers For angled valves allow an extra 72mm in total	Valve Height 79mm	Please Note Mini Cube valves are not Bi-directional
---	-----------------------------	---

Model	Description	White Ex VAT	Chrome Ex VAT	Nickel Ex VAT	White Inc VAT	Chrome Inc VAT	Nickel Inc VAT
VVMICUAN	Angled Only	£111.00	£111.00	£135.00	£133.20	£133.20	£162.00

Curve Valve shown on page 25



White Angled Wheelhead & Lockshield

Pipe Centers For angled valves allow an extra 80mm in total	Valve Height 93mm	Please Note Curve valves are not Bi-directional
---	-----------------------------	---

Model	Description	White Ex VAT	Chrome Ex VAT	Nickel Ex VAT
WCURV	Angled or straight	£91.00	£91.00	£118.00

Model	Description	White Inc VAT	Chrome Inc VAT	Nickel Inc VAT
WCURV	Angled or straight	£109.20	£109.20	£141.60

Ellipse shown on pages 17 & 23



Nickel Angled Wheelhead & Lockshield

Pipe Centers For angled valves allow an extra 80mm in total	Valve Height 115mm	Please Note Ellipse valves are not Bi-directional
---	------------------------------	---

Model	Description	White Ex VAT	Chrome Ex VAT	Nickel Ex VAT
WELL	Angled or straight	£93.00	£93.00	£132.00

Model	Description	White Inc VAT	Chrome Inc VAT	Nickel Inc VAT
WELL	Angled or straight	£111.60	£111.60	£158.40

Standard shown on pages 6 & 43

All stocked valves have prices listed in purple and will be delivered in 3 - 5 working days.

Available with a standard white top or optional coloured top to match your radiator or valve body.



White

Chrome

Nickel Straight



Nickel Angled Wheelhead & Lockshield

Pipe Centers For angled valves allow an extra 80mm in total	Valve Height 86mm	Please Note Standard valves are not Bi-directional
---	-----------------------------	--

Model	Description	White Ex VAT	Chrome Ex VAT	Nickel Ex VAT	White Inc VAT	Chrome Inc VAT	Nickel Inc VAT
VVSTA	Angled or straight	£97.00	£97.00	£107.00	£116.40	£116.40	£128.40

Coloured Valve Tops (standard valves only)



Model	Description	Black Ex VAT	Chrome Ex VAT	Nickel Ex VAT	Black Inc VAT	Chrome Inc VAT	Nickel Inc VAT
VVSTATOP	Valve tops	£15.00	£15.00	£15.00	£18.00	£18.00	£18.00

3 Style Valve shown on page 74, 80 & 81



White

Silver

Chrome Angled Wheelhead & Lockshield

Chrome Straight

These valves are perfect for towel rails.

Pipe Centers For angled valves allow an extra 80mm in total	Valve Height 55mm	Please Note 3Style valves are not Bi-directional
---	-----------------------------	--

Model	Description	White Ex VAT	Chrome Ex VAT	Silver Ex VAT
VV3STY	Angled or straight	£108.00	£94.00	£122.00

Model	Description	White Inc VAT	Chrome Inc VAT	Silver Inc VAT
VV3STY	Angled or straight	£129.60	£112.80	£146.40

Classic Valve



Angled Wheelhead & Lockshield

Straight

Pipe Centers For angled valves allow an extra 105mm in total	Valve Height 105mm	Please Note Classic valves are not Bi-directional
--	------------------------------	---

Model	Description	Bronze Ex VAT	Bronze Inc VAT
WVCL	Angled or straight	£169.00	£202.80

The Classic Valve is available in 15mm copper and 22mm iron connections. Please specify at the time of order.

All stocked accessories have prices listed in purple and will be delivered in 3 - 5 working days.

Black & Brass



Angled Wheelhead & Lockshield

Pipe Centers For angled valves allow an extra 80mm in total	Valve Height 105mm	Please Note Black & Brass valves are not Bi-directional
---	------------------------------	---

Model	Description	Brass Ex VAT	Brass Inc VAT
VVB&BANB	Angled Only	£77.00	£92.40

Black & Brass TRV



Angled Wheelhead & Lockshield

Pipe Centers For angled valves allow an extra 80mm in total	Valve Height 133mm	Please Note Black & Brass TRV valves are not Bi-directional
---	------------------------------	---

Model	Description	Brass Ex VAT	Brass Inc VAT
VVB&BTRVANB	Angled Only	£107.00	£128.40

Vienna shown on page 65



Anthracite

Bronze Angled Wheelhead & Lockshield

Bronze Straight

Pipe Centers For angled valves allow an extra 105mm in total	Valve Height 103mm	Please Note Vienna valves are not Bi-directional
--	------------------------------	--

Model	Description	Bronze Ex VAT	Anthracite Ex VAT	Bronze Inc VAT	Anthracite Inc VAT
VVIE	Angled or straight	£90.00	£90.00	£108.00	£108.00

Please Note: The Vienna valve is available in 15mm copper and 22mm iron connections, please specify at the time of order.

Vienna TRV shown on pages 64 & 67



Anthracite Angled Wheelhead & Lockshield

Bronze Angled

Pipe Centers For angled valves allow an extra 105mm in total	Valve Height 130mm	Please Note Vienna TRV valves are not Bi-directional
--	------------------------------	--

Model	Description	Bronze Ex VAT	Anthracite Ex VAT	Bronze Inc VAT	Anthracite Inc VAT
VVITRV	Angled or straight	£124.00	£124.00	£148.80	£148.80

Please Note: The Vienna TRV valve is available in 15mm copper and 22mm iron connections, please specify at the time of order.

Accessories Pipe covers & Shrouds

We offer 4 different options for you to choose from;

1. Matching Pipe covers & shrouds available in 6 set colours; White, Chrome, Antique Copper, Nickel, Antique Brass & Black.

Pipe covers and shrouds are the perfect method of creating a neat finish for your radiator, they remove the need to paint copper pipes and hide unsightly holes drilled in the floor or wall for the feed pipe. Available in 6 standard finishes they can be delivered in 3- 5 working days. Each set is supplied with two 160mm covers and two shrouds.



Model	Description	Chrome Ex VAT	Nickel Ex VAT	White Ex VAT	Antique Copper Ex VAT	Antique Brass Ex VAT	Black Ex VAT
AAPIPECOV	Pipe covers	£34.00	£40.00	£34.00	£40.00	£40.00	£40.00

Model	Description	Chrome Inc VAT	Nickel Inc VAT	White Inc VAT	Antique Copper Inc VAT	Antique Brass Inc VAT	Black Inc VAT
AAPIPECOV	Pipe covers	£40.80	£48.00	£40.80	£48.00	£48.00	£48.00

2. Painted Pipe Covers and Shrouds

For a totally co-ordinated look you can order matching pipe covers and shrouds to complete your Ancona, Tornado or Volcano. They can be ordered in the same colour and only at the same time as your chosen radiator in any one of 188 RAL colours and 11 special finishes; see colour group  on page 96.



Mottled Copper Pipe Covers & Shrouds

Textured Black Pipe Covers & Shrouds

Model	Colour Ex VAT	Colour Inc VAT
AAPIPECOV	£54.00	£64.80

Each set is supplied with 2 x 160mm pipe covers 2 shrouds, delivery on coloured pipe covers is 4 weeks.

Please Note: Painted Pipe covers & Shrouds must be ordered at the same time as your radiators & towel rails and in the same colour.

3. Telescopic Pipe Covers and Shrouds

Made from solid Brass these simple to fit, telescopic pipe covers, match perfectly with our range of solid brass valves. The main pipe cover, slides into the bass plate and can be adjusted to fit without the need for cutting. The overall maximum height is 125mm. These pipes and shrouds are only suitable for the following valves; Worcester, Buckingham TRV and TRC valves. Available from stock in 3 - 5 working days. Available in Chrome, Satin Nickel, Brass, Antique Copper and Antique Brass.



Model	Description	Price Ex VAT	Price Inc VAT
AATPC	Telescopic Pipe Covers	£59.00	£70.80

Please specify your chosen finish at time of order; Chrome, Satin Nickel, Brass, Antique Copper & Antique Brass.

4. Radsnaps

This is the most simple and cost effective concept for tackling the age-old problem of decorating visible or exposed pipes. Principally designed to cover pipes from floor to valves, the radsnaps are pre-curved plastic tubes that can be cut to size with scissors. Simply snap on the pipe to give a neat finish. Available from stock in white or chrome.

Model	Description	White Ex VAT	Chrome Ex VAT	White Inc VAT	Chrome Inc VAT
AAPIPES3X1	3 x 100cm	£13.00	£15.00	£15.60	£18.00



White Radsnap

Accessories

All stocked accessories have prices listed in purple and will be delivered in 3 - 5 working days.

Aladdin Automatic Radiator Airvents

Aladdin airvents are designed to save energy, keep radiators hot-to-top, reduce corrosion and system noise, to help provide maintenance free radiators.

The innovative Hygroseal™ technology (patent pending) provides a cost-effective solution to automatic radiator venting. The valves are fully automatic, requiring no manual adjustment and installing the valves is a simple job that does not require the system to be drained.

The range is available in 2 versions; HV30c with changeable cartridge and the Micro; all guaranteed for 3 years. The HV30c can also be provided with a matching blanking plug.



Aladdin automatic airvent shown in chrome.



Performance tested for leak free, automatic venting.

Model	Description	Brass Ex VAT	Chrome Ex VAT	Brass Inc VAT	Chrome Inc VAT
AAAUTVALHV30C	Airvent Only	£8.60	£8.60	£10.32	£10.32
AAAUTVALHV30CX12	Box of 12 Airvent Only	£97.03	£97.03	£116.44	£116.44
AAAUTVALHV30CBP	Airvent & Blanking Plug	£10.04	£10.04	£12.05	£12.05
AAAUTVALHV30CBPX12	Box of 12 Airvent & Blanking Plug	£113.29	£113.29	£135.95	£135.95
AAAUTVALMICROC	Micro Airvent Only	N/A	£8.60	N/A	£10.32
AAAUTVALMICROCX12	Box of 12 Micro Airvent Only	N/A	£97.03	N/A	£116.44



HV30C Airvent in chrome



Micro airvent; fits 1/8" and 1/4" BSP + 5, 6 and 7mm threads

Micro airvent

Please note spare replacement airvent cartridges are available if required.

Model	Description	Brass Ex VAT	Chrome Ex VAT	Brass Inc VAT	Chrome Inc VAT
AAAUTVALCART	Airvent Cartridge	£2.48	£2.48	£2.98	£2.98
AAAUTVALCARTX12	Box of 12 Airvent Cartridge	£27.92	£27.92	£33.50	£33.50

Manual Brass Airvents

As an alternative, why not order Ancona manual brass airvent.

Model	Description	Ex VAT	Inc VAT
PPSSAV01B	Brass airvent	£3.00	£3.60

1 airvent is needed per Ancona radiator; please specify at time of order. This airvent will not fit other radiators or towel rails.



Ancona Towel Bars

Made from brass with a chrome finish the new Ancona towel bars can be added to any (new or existing) Ancona to provide useful hanging space in kitchens or bathrooms.

Model	Description	Price Ex VAT	Price Inc VAT
ANCOTB8C	To fit 8 sections or more	£51.00	£61.20
ANCOTB12C	To fit 12 sections or more	£60.00	£72.00
ANCOTB16C	To fit 16 sections or more	£68.00	£81.60



690mm; 16 sections or more



506mm; 12 sections or more



322mm; 8 sections or more

Towel Bars and Pegs

These towel bars and hanging pegs are designed to fit the majority of ladder style rails and vertical tube radiators. Ideal for providing additional hanging space to air towels or hang bathrobes, they are available from stock in white or chrome.

Towel Bars

Model	Length	White Ex VAT	Chrome Ex VAT	White Inc VAT	Chrome Inc VAT
AAHBAR360	360mm	£31.00	£36.00	£37.20	£43.20
AAHBAR560	560mm	£32.00	£37.00	£38.40	£44.40



White Towel Bar



Chrome Towel Bar



White Hanging Peg



Chrome Hanging Peg

Hanging Pegs

Model	White Ex VAT	Chrome Ex VAT	White Inc VAT	Chrome Inc VAT
AAHPEGPAIR	£19.00	£23.00	£22.80	£27.60

Accessories for Aluminium Radiators

End Panels

These end panels are designed to fit the Vip and Oscar models and create a clean end profile.

Vip End Panels

Model	Height (mm)	White Ex VAT	White Inc VAT
VIPEP44	440	£38.00	£45.60
VIPEP59	590	£42.00	£50.40
VIPEP69	690	£45.00	£54.00
VIPEP79	790	£47.00	£56.40
VIPEP89	890	£50.00	£60.00

Price is per pair



Vip End Panel

Oscar End Panels

Model	Height (mm)	White Ex VAT	White Inc VAT
OSCAEP10	1020	£61.00	£73.20
OSCAEP12	1220	£64.00	£76.80
OSCAEP14	1420	£68.00	£81.60
OSCAEP16	1620	£79.00	£94.80
OSCAEP18	1820	£82.00	£98.40
OSCAEP20	2020	£85.00	£102.00

Price is per pair



Oscar End Panel

Aluminium Pegs & Bars

These towel bars and pegs are designed to fit all our sectional aluminium range. Ideal for providing additional hanging space to air towels or hang bathrobes.

Model	Description / Suitable for	White Ex VAT	Chrome Ex VAT	White Inc VAT	Chrome Inc VAT
AAHPEG01	Peg / Vip, Mix, Vox, Klass	£15.00	£18.00	£18.00	£21.60
AAHPEG02	Peg / Oscar	£15.00	£18.00	£18.00	£21.60
AAHPEG03	Peg / Ekos & Extra	£13.00	£16.00	£15.60	£19.20
AAHBAR01	Bar 480mm / Vip, Mix, Vox, Klass	£47.00	£54.00	£56.40	£64.80
AAHBAR02	Bar 320mm / Vip, Mix, Vox, Klass	£47.00	£54.00	£56.40	£64.80
AAHBAR03	Bar 480mm / Oscar	£47.00	£54.00	£56.40	£64.80
AAHBAR04	Bar 320mm / Oscar	£47.00	£54.00	£56.40	£64.80
AAHBAR05	Bar 480mm / Ekos & Extra	£47.00	£54.00	£56.40	£64.80
AAHBAR06	Bar 320mm / Ekos & Extra	£47.00	£54.00	£56.40	£64.80



White Hanging Peg



Chrome Hanging Peg



White Towel Bar



Chrome Towel Bar

Radiator Brushes

These brushes are perfect for quickly and easily cleaning tricky, hard to reach places in sectional aluminium radiators or between the bars of tubular radiators and towel rails. Available from stock.

Model	Description	Ex VAT	Inc VAT
AABRUSHM	Multi Brush	£35.00	£42.00
AABRUSHS	Single Brush	£27.00	£32.40



Multi Brush



Single Brush

Accessories

All stocked accessories have prices listed in purple and will be delivered in 3 - 5 working days.

Dual Application Kits

Dual application is a great way to warm your towels during the summer months when the main heating system is turned off. Adapting your towel rail to dual fuel is easy to achieve; a separate 'T-piece' or Dual Application valve is used to allow the installation of an electric element alongside the standard water feed pipe.

Follow these simple stages to select the correct Dual Application Kit for your towel rail.

1. Valve Configurations

The pictures opposite show a Poll Chrome with three valve options, two showing the addition of an electric element; note the positions of the valve tail for the water pipe, in each option.

All radiators will require a valve, select either a T-piece or a Dual Application valve to suit your installation.



2. Types of Element

There are three types of electric element to choose from;

A) **Basic;** this element has basic functionality, it maintains a constant heat and is either on or off. Control is via a switched fused spur the neon light indicates if the element is on.

B) **Manual Thermostatic;** these elements monitor the temperature of the towel rail and activate the element as required. They have a range of set temperature options which can be selected manually.

C) **Digital thermostatic;** an element with the facility to set desired temperature and operational periods. Fully programmable with digital control panel & display.



Round head
white & chrome
200, 300, 400, 600,
800 & 1000 watts.



Thermostatic element
white & chrome 300,
600 & 1000 watts



Round head Thermostatic element
white, chrome & silver
200, 300, 400, 600,
800 & 1000 watts.



Square element
white & silver 200,
300, 600, 800
& 1000 watts.

3. How to choose your Element

It is important to select the correct size element for your towel rail. Too small and it will not provide enough heat, too large and it can burn out.

The chart opposite will help you choose the right size element; we have listed the towel rail output in watts and the corresponding recommended size of element.

Towel Rail output in watts	Electric Elements
Up to 359	200w
360 - 479	300w
480 - 719	400w
720 - 959	600w
960 - 1199	800w
1200 plus	1000w

Accessories

All stocked accessories have prices listed in purple and will be delivered in 3 - 5 working days.

Dual Application Kits continued

Once you have chosen the size of element you need for your towel rail, please choose one of the kits below that suits both the output and the design you need. You can choose any of our valves to work with your dual application kit, (however we would NOT recommend a thermostatic valve) or select the dual application valve for a neater finish. Please note dual application kits do not work with 50mm connections or valves.

All kits are supplied with a 50mm T-piece as standard; 75mm T-pieces are available as an optional extra, see below.

Dual Application Kit price chart

Model	Description	Output	IP Rating	White Ex VAT	Silver Ex VAT	Chrome Ex VAT	White Inc VAT	Silver Inc VAT	Chrome Inc VAT
AAELE	Round head element	200, 300, 400, 600, 800 & 1000 watts	IP 55	£57.00	N/A	£62.00	£68.40	N/A	£74.40
AARHTELE	Round head thermostatic element	200, 300, 400, 600, 800 & 1000 watts	IP 55	£83.00	£86.00	£97.00	£99.60	£103.20	£116.40
AATELE	Thermostatic element	300, 600, 1000 watt	IP 54	£91.00	N/A	£98.00	£109.20	N/A	£117.60
AASQDELE	Digital Square Element	200, 300, 600, 800 & 1000 watts	IP 65	£107.00	£110.00	N/A	£128.40	£132.00	N/A

Please specify white, chrome or silver at time of order. All elements come with a 2 year warranty.

75mm T-Piece

75mm T-Pieces are available as an optional extra, if you need additional length to match your pipe centres or you would like a different aesthetic finish.

Model	Description	Price Ex VAT	Price Inc VAT
AATPIECE75	Chrome T-Piece 75mm	£4.00	£4.80
AATPIECE75	White T-Piece 75mm	£4.00	£4.80
AATPIECE75	Brushed Nickel T-Piece 75mm	£4.00	£4.80



Dual Application Valve

All towel rails that use the central heating system to heat up require valves; the Dual Application Valve has been specifically designed for use with electric elements. Combining the role of the valve and T piece it has an entry point for the element; this creates a neater finish and keeps pipe centres in line with the collector preventing major changes in pipe work.

Model	Description	White Ex VAT	Chrome Ex VAT	White Inc VAT	Chrome Inc VAT
WCOMB	Dual Application valve	£116.00	£116.00	£139.20	£139.20



Metacrylic shown on page 6



Model	Height A (mm)	Width B (mm)	Description	Watts At 50°C	Btu's At 50°C	Price Ex VAT	Price Inc VAT
METAV1256CB	1220	560	Clear on black	623	2126	£2,043.00	£2,451.80
METAV1856CB	1820	560	Clear on black	924	3154	£2,215.00	£2,658.00
METAV2056CB	2020	560	Clear on black	1028	3509	£2,348.00	£2,817.60
METAV1256CS	1220	560	Clear on satinato	623	2126	£2,229.00	£2,674.80
METAV1856CS	1820	560	Clear on satinato	924	3154	£2,401.00	£2,881.20
METAV2056CS	2020	560	Clear on satinato	1028	3509	£2,547.00	£3,056.40
METAV1256BW	1220	560	Black on white	623	2126	£1,924.00	£2,308.80
METAV1856BW	1820	560	Black on white	924	3154	£2,096.00	£2,515.20
METAV2056BW	2020	560	Black on white	1028	3509	£2,229.00	£2,674.80
METAV1256BS	1220	560	Black on satinato	623	2126	£2,229.00	£2,674.80
METAV1856BS	1820	560	Black on satinato	924	3154	£2,401.00	£2,881.20
METAV2056BS	2020	560	Black on satinato	1028	3509	£2,547.00	£3,056.40
METAV1256VW	1220	560	Verde on white	623	2126	£1,924.00	£2,308.80
METAV1856VW	1820	560	Verde on white	924	3154	£2,096.00	£2,515.20
METAV2056VW	2020	560	Verde on white	1028	3509	£2,229.00	£2,674.80
METAV1256RS	1220	560	Red on satinato	623	2126	£2,229.00	£2,674.80
METAV1856RS	1820	560	Red on satinato	924	3154	£2,401.00	£2,881.20
METAV2056RS	2020	560	Red on satinato	1028	3509	£2,547.00	£3,056.40
METAV1256RW	1220	560	Red on White	623	2126	£1,924.00	£2,308.80
METAV1856RW	1820	560	Red on White	924	3154	£2,096.00	£2,515.20
METAV2056RW	2020	560	Red on White	1028	3509	£2,229.00	£2,674.80

To order your Metacrylic radiator please;

1. Select your preferred design (Wall, Scuba, Flora or Rain) from page 6 or see below.
2. Choose from one of our 7 colour options which are; Black on White, Verde on White, Black on Satinato, Clear on Satinato, Clear on Black, Red on Satinato and Red on White. See page 6.
3. Choose the required size from the table opposite.
4. Place your order specifying design, size & colour option.

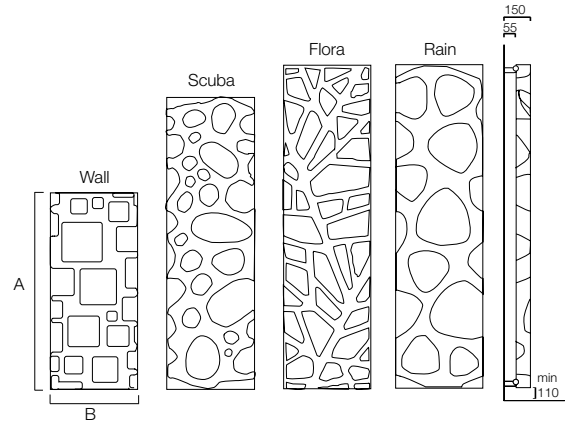

Metacrylic	Pipe centres left to right	Pipe centres from wall	Depth from wall
Metacrylic	width - 30mm + valves	55mm	150mm
Automatic bleed valve included with these radiators			

Underneath Connections	Ex VAT	Inc VAT
B2CONN	£91.00	£109.20
Underneath Connections must be specified at time of order.		
Underneath Connections pipe centres = width - 75mm		

Shine shown on page 7



Model	Height A (mm)	Width B (mm)	Watts At 50°C	Btu's At 50°C	Price Ex VAT	Price Inc VAT
SHIN1859	1820	590	924	3154	£2,777.00	£3,332.40

Please specify Black or White radiator with clear acrylic cover at time of order.

Shine	Pipe centres left to right	Pipe centres from wall	Depth from wall
Shine	width - 30mm + valves	70mm	165mm
Automatic bleed valve included with these radiators			

Underneath Connections	Ex VAT	Inc VAT
B2CONN	£91.00	£109.20
Underneath Connections must be specified at time of order.		
Underneath Connections pipe centres = width - 75mm		

Important Note:

The Shine has built in, dimmable, LED lighting which operates using a 12v transformer (provided), it is important therefore that a suitable plug socket is located close to the final position of the radiator. The connection socket and dimmer control are positioned on the right hand side of the radiator.

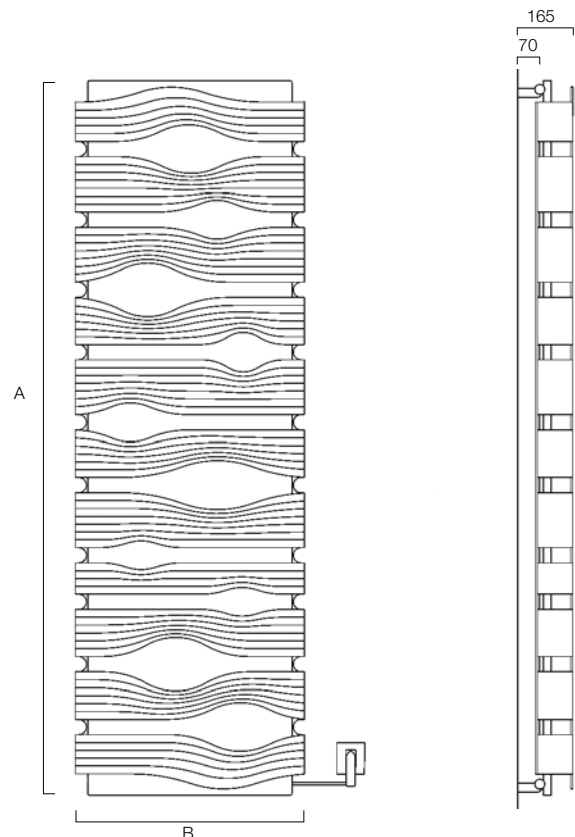



Flat Single Horizontal

Model	Height A (mm)	Width B (mm)	Watts Δt 50°C	Btu's Δt 50°C	White Ex VAT	Colours Ex VAT	White Inc VAT	Colours Inc VAT
FLATSH3717	375	1725	1050	3584	£849.00	£1,062.00	£1,018.80	£1,274.40
FLATSH4917	495	1725	1421	4850	£971.00	£1,214.00	£1,165.20	£1,456.80
FLATSH6617	663	1725	1920	6553	£1,093.00	£1,366.00	£1,311.60	£1,639.20
FLATSH3720	375	2025	1236	4218	£890.00	£1,112.00	£1,068.00	£1,334.40
FLATSH4920	495	2025	1672	5707	£1,027.00	£1,284.00	£1,232.40	£1,540.80
FLATSH6620	663	2025	2259	7710	£1,165.00	£1,456.00	£1,398.00	£1,747.20

horizontal single
88

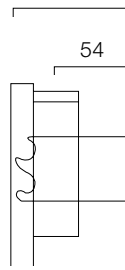

horizontal double
88

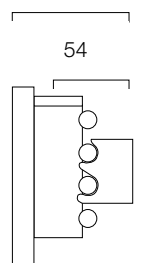

Flat Double Horizontal

Model	Height A (mm)	Width B (mm)	Watts Δt 50°C	Btu's Δt 50°C	White Ex VAT	Colours Ex VAT	White Inc VAT	Colours Inc VAT
FLATDH3717	375	1725	1782	6082	£1,123.00	£1,403.00	£1,347.60	£1,683.60
FLATDH4917	495	1725	2331	7956	£1,354.00	£1,692.00	£1,624.80	£2,030.40
FLATDH6617	663	1725	3062	10451	£1,583.00	£1,979.00	£1,899.60	£2,374.80
FLATDH3720	375	2025	1992	6799	£1,198.00	£1,498.00	£1,437.60	£1,797.60
FLATDH4920	495	2025	2605	8891	£1,459.00	£1,824.00	£1,750.80	£2,188.80
FLATDH6620	663	2025	3422	11679	£1,722.00	£2,153.00	£2,066.40	£2,583.60

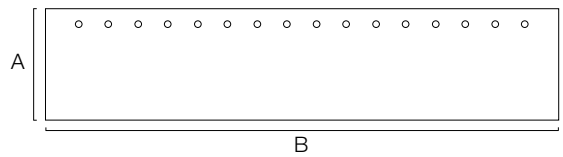

Flat horizontal	Pipe centres left to right	Pipe centres from wall	Depth from wall
Flat horizontal	width - 65mm	54mm	88mm
Automatic bleed valve included with these radiators			

Flat Single Vertical

Model	Height A (mm)	Width B (mm)	Watts Δt 50°C	Btu's Δt 50°C	White Ex VAT	Colours Ex VAT	White Inc VAT	Colours Inc VAT
FLATSV1737	1725	375	995	3396	£849.00	£1,062.00	£1,018.80	£1,274.40
FLATSV1749	1725	495	1326	4526	£971.00	£1,214.00	£1,165.20	£1,456.80
FLATSV1766	1725	663	1790	6109	£1,093.00	£1,366.00	£1,311.60	£1,639.20
FLATSV2037	2025	375	1151	3928	£890.00	£1,112.00	£1,068.00	£1,334.40
FLATSV2049	2025	495	1534	5236	£1,027.00	£1,284.00	£1,232.40	£1,540.80
FLATSV2066	2025	663	2071	7068	£1,165.00	£1,456.00	£1,398.00	£1,747.20

vertical single
88

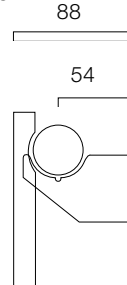

vertical double
88

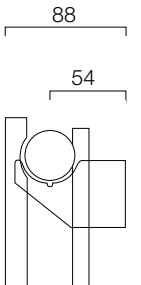

Flat Double Vertical

Model	Height A (mm)	Width B (mm)	Watts Δt 50°C	Btu's Δt 50°C	White Ex VAT	Colours Ex VAT	White Inc VAT	Colours Inc VAT
FLATDV1737	1725	375	1464	4997	£1,123.00	£1,403.00	£1,347.60	£1,683.60
FLATDV1749	1725	495	1953	6666	£1,354.00	£1,692.00	£1,624.80	£2,030.40
FLATDV1766	1725	663	2636	8997	£1,583.00	£1,979.00	£1,899.60	£2,374.80
FLATDV2037	2025	375	1691	5771	£1,198.00	£1,498.00	£1,437.60	£1,797.60
FLATDV2049	2025	495	2254	7693	£1,459.00	£1,824.00	£1,750.80	£2,188.80
FLATDV2066	2025	663	3043	10386	£1,722.00	£2,153.00	£2,066.40	£2,583.60

A

B

Flat vertical	Pipe centres left to right	Pipe centres from wall	Depth from wall
Flat vertical	width + valves	54mm	88mm
Automatic bleed valve included with these radiators			

Underneath Connections	Ex VAT	Inc VAT
B2CONN	£91.00	£109.20
Underneath Connections must be specified at time of order.		
Underneath Connections pipe centres = width - 65mm		



Ice Inox shown on pages 8 - 9



All stocked radiators have prices listed in purple and will be delivered in 3 - 5 working days.

Ice Inox Single Vertical

Model	Height A (mm)	Width B (mm)	Watts Δt 50°C	Btu's Δt 50°C	Polished Stainless Steel Ex VAT	Brushed Stainless Steel Ex VAT	Polished Stainless Steel Inc VAT	Brushed Stainless Steel Inc VAT
ICEINSV1245	1220	465	400	1365	£964.00	£890.00	£1,156.80	£1,068.00
ICEINSV1260	1220	615	534	1822	£1,100.00	£1,078.00	£1,320.00	£1,293.60
ICEINSV1545	1520	465	497	1696	£1,215.00	£908.00	£1,458.00	£1,089.60
ICEINSV1560	1520	615	662	2259	£1,319.00	£1,117.00	£1,582.80	£1,340.40
ICEINSV1845	1820	465	595	2030	£1,283.00	£983.00	£1,539.60	£1,179.60
ICEINSV1853	1820	540	693	2365	£1,330.00	£1,059.00	£1,596.00	£1,270.80
ICEINSV1860	1820	615	793	2706	£1,399.00	£1,173.00	£1,678.80	£1,407.60

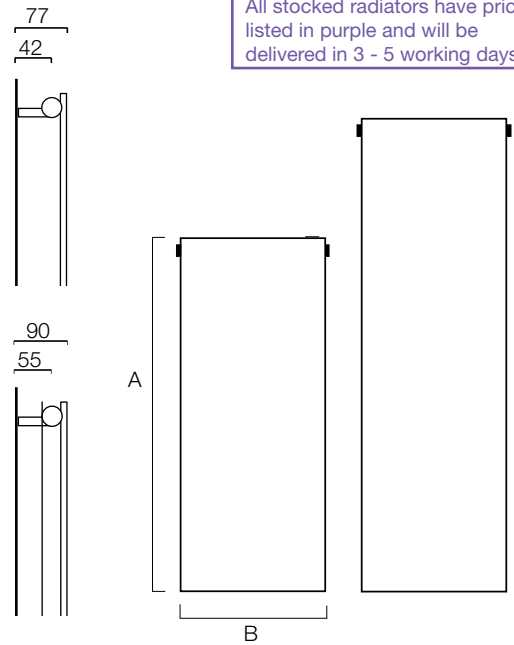

Ice Inox Double Vertical

Model	Height A (mm)	Width B (mm)	Watts Δt 50°C	Btu's Δt 50°C	Polished Stainless Steel Ex VAT	Brushed Stainless Steel Ex VAT	Polished Stainless Steel Inc VAT	Brushed Stainless Steel Inc VAT
ICEINDV1245	1220	465	630	2150	£1,306.00	£1,192.00	£1,567.20	£1,430.40
ICEINDV1260	1220	615	909	3102	£1,445.00	£1,438.00	£1,734.00	£1,725.60
ICEINDV1545	1520	465	839	2863	£1,559.00	£1,210.00	£1,870.80	£1,452.00
ICEINDV1560	1520	615	1118	3815	£1,662.00	£1,495.00	£1,994.40	£1,794.00
ICEINDV1845	1820	465	1003	3422	£1,628.00	£1,304.00	£1,953.60	£1,564.80
ICEINDV1853	1820	540	1080	3685	£1,675.00	£1,400.00	£2,010.00	£1,680.00
ICEINDV1860	1820	615	1337	4562	£1,742.00	£1,571.00	£2,090.40	£1,885.20

Ice Inox vertical	Pipe centres left to right	Pipe centres from wall	Depth from wall
Ice Inox single vertical	width - 10mm + valves	42mm	77mm
Ice Inox double vertical	width - 10mm + valves	55mm	90mm

Automatic bleed valve included with these radiators

Underneath Connections	Ex VAT	Inc VAT
B2CONN	£91.00	£109.20

Underneath Connections are made to order only, stock lines are BOE.
Underneath Connections pipe centres = width - 75mm

Ice Inox Single Horizontal

Model	Height A (mm)	Width B (mm)	Watts Δt 50°C	Btu's Δt 50°C	Polished Stainless Steel Ex VAT	Brushed Stainless Steel Ex VAT	Polished Stainless Steel Inc VAT	Brushed Stainless Steel Inc VAT
ICEINSH4512	465	1220	416	1419	£1,021.00	£952.00	£1,225.20	£1,142.40
ICEINSH6012	615	1220	556	1897	£1,157.00	£1,154.00	£1,388.40	£1,384.80
ICEINSH4515	465	1520	547	1866	£1,283.00	£972.00	£1,539.60	£1,166.40
ICEINSH6015	615	1520	728	2484	£1,399.00	£1,195.00	£1,678.80	£1,434.00
ICEINSH4518	465	1820	661	2255	£1,376.00	£1,055.00	£1,651.20	£1,266.00
ICEINSH5318	540	1820	778	2655	£1,422.00	£1,134.00	£1,706.40	£1,360.80
ICEINSH6018	615	1820	880	3003	£1,502.00	£1,255.00	£1,802.40	£1,506.00

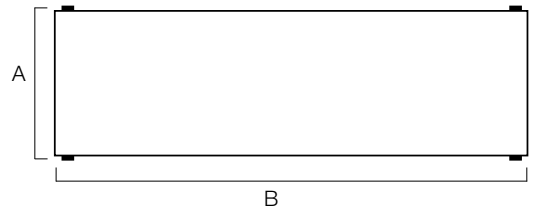

Ice Inox Double Horizontal

Model	Height A (mm)	Width B (mm)	Watts Δt 50°C	Btu's Δt 50°C	Polished Stainless Steel Ex VAT	Brushed Stainless Steel Ex VAT	Polished Stainless Steel Inc VAT	Brushed Stainless Steel Inc VAT
ICEINDH4512	465	1220	710	2423	£1,399.00	£1,276.00	£1,678.80	£1,531.20
ICEINDH6012	615	1220	946	3228	£1,536.00	£1,538.00	£1,843.20	£1,845.60
ICEINDH4515	465	1520	922	3146	£1,651.00	£1,296.00	£1,981.20	£1,555.20
ICEINDH6015	615	1520	1229	4193	£1,766.00	£1,599.00	£2,119.20	£1,918.80
ICEINDH4518	465	1820	1144	3903	£1,742.00	£1,396.00	£2,090.40	£1,675.20
ICEINDH5318	540	1820	1334	4552	£1,788.00	£1,498.00	£2,145.60	£1,797.60
ICEINDH6018	615	1820	1525	5203	£1,868.00	£1,681.00	£2,241.60	£2,017.20

Ice Inox horizontal	Pipe centres left to right	Pipe centres from wall	Depth from wall
Ice Inox single horizontal	width - 60mm	32mm - 42mm	65mm - 75mm
Ice Inox double horizontal	width - 60mm	77mm - 87mm	110mm - 120mm

Automatic bleed valve included with these radiators

Non stock radiators are bespoke & made to order. Delivery times may be extended during factory holiday closures in Jul/Aug & Dec. Delivery times will be confirmed at time of order.



All stocked radiators have prices listed in purple and will be delivered in 3 - 5 working days.

Ice Single Vertical

Model	Height A (mm)	Width B (mm)	Watts Δt 50°C	Btu's Δt 50°C	White Ex VAT	Colours Ex VAT	White Inc VAT	Colours Inc VAT
ICESV1245	1220	465	534	1822	£646.00	£807.00	£775.20	£968.40
ICESV1260	1220	615	712	2429	£785.00	£980.00	£942.00	£1,176.00
ICESV1545	1520	465	663	2262	£660.00	£825.00	£792.00	£990.00
ICESV1560	1520	615	883	3013	£811.00	£1,015.00	£973.20	£1,218.00
ICESV1845	1820	465	793	2706	£715.00	£894.00	£858.00	£1,072.80
ICESV1853	1820	540	924	3153	£770.00	£964.00	£924.00	£1,156.80
ICESV1860	1820	615	1057	3606	£853.00	£1,066.00	£1,023.60	£1,279.20
ICESV2045	2020	465	881	3006	£770.00	£964.00	£924.00	£1,156.80
ICESV2060	2020	615	1175	4009	£894.00	£1,118.00	£1,072.80	£1,341.60

Ice Double Vertical

Model	Height A (mm)	Width B (mm)	Watts Δt 50°C	Btu's Δt 50°C	White Ex VAT	Colours Ex VAT	White Inc VAT	Colours Inc VAT
ICEDV1245	1220	465	801	2733	£866.00	£1,083.00	£1,039.20	£1,299.60
ICEDV1260	1220	615	1070	3651	£1,045.00	£1,306.00	£1,254.00	£1,567.20
ICEDV1545	1520	465	987	3368	£880.00	£1,100.00	£1,056.00	£1,320.00
ICEDV1560	1520	615	1315	4487	£1,086.00	£1,358.00	£1,303.20	£1,629.60
ICEDV1845	1820	465	1180	4026	£949.00	£1,186.00	£1,138.80	£1,423.20
ICEDV1853	1820	540	1377	4698	£1,018.00	£1,273.00	£1,221.60	£1,527.60
ICEDV1860	1820	615	1573	5367	£1,142.00	£1,427.00	£1,370.40	£1,712.40
ICEDV2045	2020	465	1315	4487	£1,031.00	£1,290.00	£1,237.20	£1,548.00
ICEDV2060	2020	615	1753	5981	£1,196.00	£1,497.00	£1,435.20	£1,796.40

Ice Single Horizontal

Model	Height A (mm)	Width B (mm)	Watts Δt 50°C	Btu's Δt 50°C	White Ex VAT	Colours Ex VAT	White Inc VAT	Colours Inc VAT
ICESH4512	465	1220	555	1894	£674.00	£842.00	£808.80	£1,010.40
ICESH6012	615	1220	741	2528	£839.00	£1,048.00	£1,006.80	£1,257.60
ICESH4515	465	1520	730	2491	£701.00	£877.00	£841.20	£1,052.40
ICESH6015	615	1520	971	3313	£865.00	£1,083.00	£1,038.00	£1,299.60
ICESH4518	465	1820	881	3006	£756.00	£946.00	£907.20	£1,135.20
ICESH5318	540	1820	1027	3504	£825.00	£1,031.00	£990.00	£1,237.20
ICESH6018	615	1820	1174	4006	£908.00	£1,134.00	£1,089.60	£1,360.80
ICESH4520	465	2020	979	3340	£825.00	£1,031.00	£990.00	£1,237.20
ICESH6020	615	2020	1305	4453	£949.00	£1,186.00	£1,138.80	£1,423.20

Ice Double Horizontal

Model	Height A (mm)	Width B (mm)	Watts Δt 50°C	Btu's Δt 50°C	White Ex VAT	Colours Ex VAT	White Inc VAT	Colours Inc VAT
ICEDH4512	465	1220	835	2849	£935.00	£1,170.00	£1,122.00	£1,404.00
ICEDH6012	615	1220	1113	3798	£1,115.00	£1,393.00	£1,338.00	£1,671.60
ICEDH4515	465	1520	1085	3702	£949.00	£1,186.00	£1,138.80	£1,423.20
ICEDH6015	615	1520	1446	4934	£1,170.00	£1,461.00	£1,404.00	£1,753.20
ICEDH4518	465	1820	1346	4593	£1,018.00	£1,273.00	£1,221.60	£1,527.60
ICEDH5318	540	1820	1570	5357	£1,086.00	£1,358.00	£1,303.20	£1,629.60
ICEDH6018	615	1820	1794	6121	£1,224.00	£1,531.00	£1,468.80	£1,837.20
ICEDH4520	465	2020	1526	5207	£1,100.00	£1,376.00	£1,320.00	£1,651.20
ICEDH6020	615	2020	2034	6940	£1,279.00	£1,599.00	£1,534.80	£1,918.80

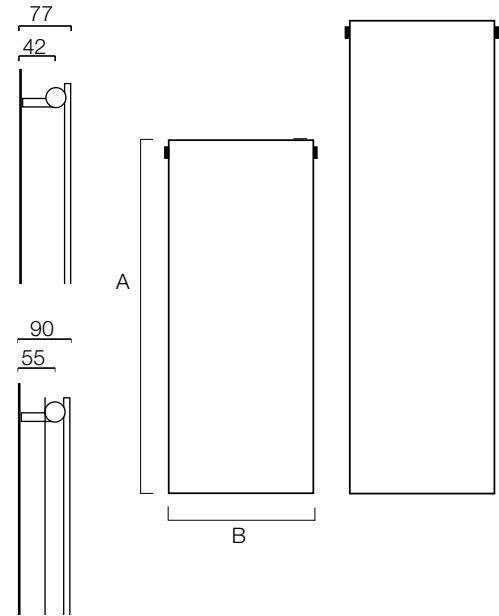

Ice vertical	Pipe centres left to right	Pipe centres from wall	Depth from wall
Ice single vertical	width - 10mm + valves	42mm	77mm
Ice double vertical	width - 10mm + valves	55mm	90mm

Automatic bleed valve included with these radiators

Underneath Connections	Ex VAT	Inc VAT
B2CONN	£91.00	£109.20

Underneath Connections are made to order only, stock lines are BOE.

Underneath Connections pipe centres = width - 75mm

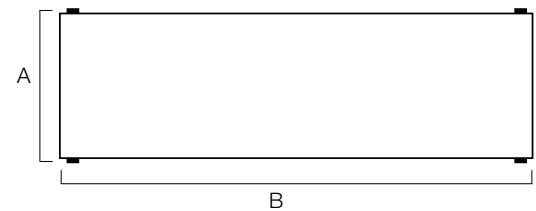

Ice horizontal	Pipe centres left to right	Pipe centres from wall	Depth from wall
Ice single horizontal	width - 60mm	32mm - 42mm	65mm - 75mm
Ice double horizontal	width - 60mm	77mm - 87mm	110mm - 120mm

Automatic bleed valve included with these radiators

For technical details on the Ice Bagno vertical and horizontal towel rails see page 143.



Tif shown on page 11



All stocked radiators have prices listed in purple and will be delivered in 3 - 5 working days.

Tif Horizontal

Model	Height A (mm)	Width B (mm)	Watts Δt 50°C	Btu's Δt 50°C	White Ex VAT	Colours Ex VAT	White Inc VAT	Colours Inc VAT
TIFH3917	398	1730	940	3208	£695.00	£868.00	£834.00	£1,041.60
TIFH5417	542	1730	1317	4495	£793.00	£991.00	£951.60	£1,189.20
TIFH6817	686	1730	1691	5771	£893.00	£1,116.00	£1,071.60	£1,339.20
TIFH3920	398	2030	1107	3778	£741.00	£927.00	£889.20	£1,112.40
TIFH5420	542	2030	1549	5287	£857.00	£1,072.00	£1,028.40	£1,286.40
TIFH6820	686	2030	1990	6792	£971.00	£1,214.00	£1,165.20	£1,456.80

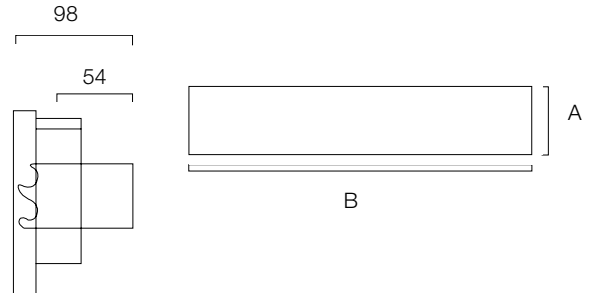

Tif Vertical

Model	Height A (mm)	Width B (mm)	Watts Δt 50°C	Btu's Δt 50°C	White Ex VAT	Colours Ex VAT	White Inc VAT	Colours Inc VAT
TIFV1739	1730	398	925	3157	£708.00	£886.00	£849.60	£1,063.20
TIFV1754	1730	542	1295	4420	£809.00	£1,011.00	£970.80	£1,213.20
TIFV1768	1730	686	1665	5683	£911.00	£1,139.00	£1,093.20	£1,366.80
TIFV2039	2030	398	1074	3666	£741.00	£927.00	£889.20	£1,112.40
TIFV2054	2030	542	1504	5133	£857.00	£1,072.00	£1,028.40	£1,286.40
TIFV2068	2030	686	1934	6601	£971.00	£1,214.00	£1,165.20	£1,456.80

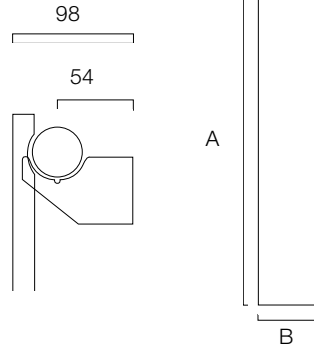

Tif	Pipe centres left to right	Pipe centres from wall	Depth from wall
Tif horizontal	width - 65mm	54mm	98mm
Tif vertical	width + valves	54mm	98mm

Automatic bleed valve included with these radiators

Underneath Connections	Ex VAT	Inc VAT
B2CONN	£91.00	£109.20

Underneath Connections are made to order only, stock lines are BOE.
Underneath Connections pipe centres = width - 110mm

Blade shown on page 13



Blade Vertical

Model	Height A (mm)	Width B (mm)	Watts Δt 50°C	Btu's Δt 50°C	White Ex VAT	Colours Ex VAT	White Inc VAT	Colours Inc VAT
BLADV1725	1700	250	402	1372	£1,495.00	£1,869.00	£1,794.00	£2,242.80

Blade Horizontal

Model	Height A (mm)	Width B (mm)	Watts Δt 50°C	Btu's Δt 50°C	White Ex VAT	Colours Ex VAT	White Inc VAT	Colours Inc VAT
BLADH2517	250	1700	402	1372	£1,495.00	£1,869.00	£1,794.00	£2,242.80

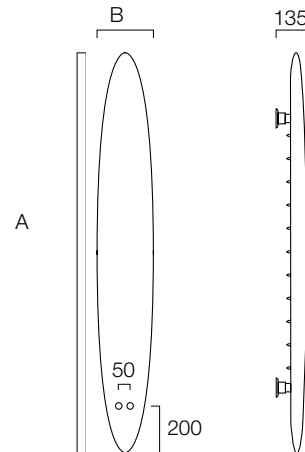

Blade	Pipe centres left to right	Depth from wall
Blade Vertical / Horizontal	50mm	135mm

Automatic bleed valve included with these radiators

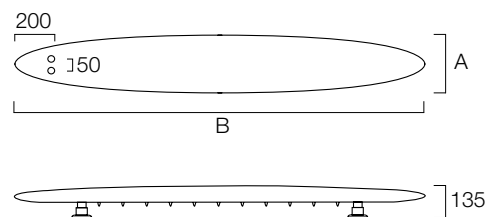

Non stock radiators are bespoke & made to order. Delivery times may be extended during factory holiday closures in Jul/Aug & Dec. Delivery times will be confirmed at time of order.



Model	Height A (mm)	Width B (mm)	Watts Δt 50°C	Btu's Δt 50°C	White Ex VAT	Colours Ex VAT	White Inc VAT	Colours Inc VAT
LOFTV1520	1500	200	336	1147	£825.00	£1,031.00	£990.00	£1,237.20
LOFTV1540	1500	403	672	2294	£1,139.00	£1,424.00	£1,366.80	£1,708.80
LOFTV1560	1500	606	1008	3440	£1,348.00	£1,685.00	£1,617.60	£2,022.00
LOFTV1720	1700	200	373	1273	£878.00	£1,097.00	£1,053.60	£1,316.40
LOFTV1740	1700	403	746	2546	£1,192.00	£1,490.00	£1,430.40	£1,788.00
LOFTV1760	1700	606	1120	3823	£1,400.00	£1,751.00	£1,680.00	£2,101.20
LOFTV2020	2000	200	439	1498	£930.00	£1,163.00	£1,116.00	£1,395.60
LOFTV2040	2000	403	878	2997	£1,244.00	£1,554.00	£1,492.80	£1,864.80
LOFTV2060	2000	606	1317	4495	£1,453.00	£1,816.00	£1,743.60	£2,179.20

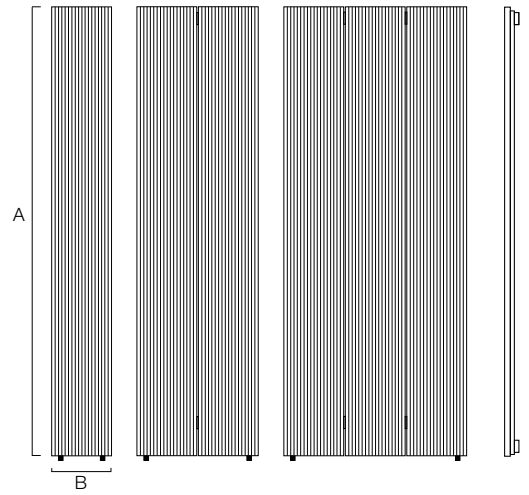

Loft Horizontal

Model	Height A (mm)	Width B (mm)	Watts Δt 50°C	Btu's Δt 50°C	White Ex VAT	Colours Ex VAT	White Inc VAT	Colours Inc VAT
LOFTH2015	200	1500	336	1147	£888.00	£1,111.00	£1,065.60	£1,333.20
LOFTH4015	403	1500	672	2294	£1,202.00	£1,502.00	£1,442.40	£1,802.40
LOFTH6015	606	1500	1008	3440	£1,411.00	£1,764.00	£1,693.20	£2,116.80
LOFTH2017	200	1700	373	1273	£972.00	£1,215.00	£1,166.40	£1,458.00
LOFTH4017	403	1700	746	2546	£1,285.00	£1,607.00	£1,542.00	£1,928.40
LOFTH6017	606	1700	1120	3823	£1,494.00	£1,868.00	£1,792.80	£2,241.60
LOFTH2020	200	2000	439	1498	£1,024.00	£1,280.00	£1,228.80	£1,536.00
LOFTH4020	403	2000	878	2997	£1,337.00	£1,672.00	£1,604.40	£2,006.40
LOFTH6020	606	2000	1317	4495	£1,546.00	£1,933.00	£1,855.20	£2,319.60

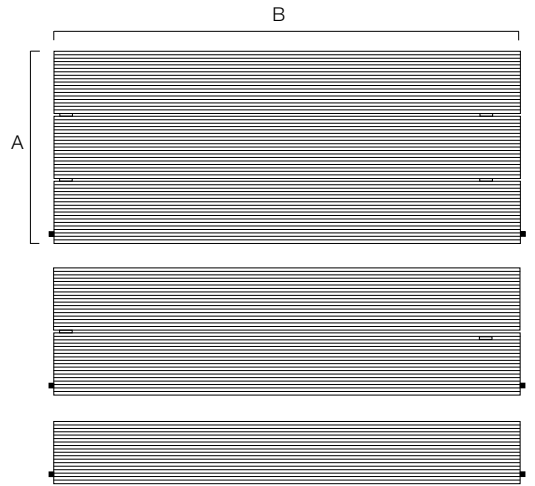

Loft	Pipe centres left to right	Pipe centres from wall	Depth from wall
Loft vertical	width - 150mm	46mm	65mm
Loft horizontal	width - 22mm + valves	46mm	65mm
Automatic bleed valve included with these radiators			



Volcano Horizontal shown on pages 14 - 15



All stocked radiators have prices listed in purple and will be delivered in 3 - 5 working days.

Volcano Single Horizontal

Model	Height A (mm)	Width B (mm)	Watts Δt 50°C	Btu's Δt 50°C	White Ex VAT	Colours Ex VAT	White Inc VAT	Colours Inc VAT
VOLCSH3257	320	571	345	1177	£207.00	£259.00	£248.40	£310.80
VOLCSH4057	400	571	430	1468	£243.00	£303.00	£291.60	£363.60
VOLCSH5257	520	571	552	1884	£258.00	£323.00	£309.60	£387.60
VOLCSH3272	320	721	424	1447	£237.00	£296.00	£284.40	£355.20
VOLCSH4072	400	721	529	1805	£275.00	£344.00	£330.00	£412.80
VOLCSH5272	520	721	695	2372	£305.00	£381.00	£366.00	£457.20
VOLCSH6072	600	721	792	2703	£331.00	£413.00	£397.20	£495.60
VOLCSH3297	320	971	552	1884	£271.00	£338.00	£325.20	£405.60
VOLCSH4097	400	971	687	2345	£322.00	£402.00	£386.40	£482.40
VOLCSH5297	520	971	896	3058	£356.00	£445.00	£427.20	£534.00
VOLCSH6097	600	971	1040	3550	£394.00	£492.00	£472.80	£590.40
VOLCSH7297	720	971	1289	4399	£441.00	£551.00	£529.20	£661.20
VOLCSH8097	800	971	1457	4973	£508.00	£635.00	£609.60	£762.00
VOLCSH3214	320	1471	803	2741	£317.00	£397.00	£380.40	£476.40
VOLCSH4014	400	1471	1008	3440	£377.00	£471.00	£452.40	£565.20
VOLCSH5214	520	1471	1317	4495	£462.00	£578.00	£554.40	£693.60
VOLCSH6014	600	1471	1510	5154	£539.00	£673.00	£646.80	£807.60
VOLCSH7214	720	1471	1947	6645	£569.00	£712.00	£682.80	£854.40
VOLCSH4017	400	1771	1195	4079	£437.00	£546.00	£524.40	£655.20
VOLCSH5217	520	1771	1610	5495	£551.00	£689.00	£661.20	£826.80
VOLCSH6017	600	1771	1908	6512	£662.00	£826.00	£794.40	£991.20
VOLCSH8017	800	1771	2400	8191	£727.00	£908.00	£872.40	£1,089.60
VOLCSH4019	400	1971	1323	4515	£479.00	£599.00	£574.80	£718.80
VOLCSH5219	520	1971	1805	6160	£572.00	£715.00	£686.40	£858.00
VOLCSH8019	800	1971	2640	9010	£773.00	£966.00	£927.60	£1,159.20

Volcano Double Horizontal

Model	Height A (mm)	Width B (mm)	Watts Δt 50°C	Btu's Δt 50°C	White Ex VAT	Colours Ex VAT	White Inc VAT	Colours Inc VAT
VOLCDH3257	320	571	577	1969	£221.00	£275.00	£265.20	£330.00
VOLCDH4057	400	571	720	2457	£273.00	£341.00	£327.60	£409.20
VOLCDH5257	520	571	922	3147	£305.00	£381.00	£366.00	£457.20
VOLCDH3272	320	721	708	2416	£279.00	£350.00	£334.80	£420.00
VOLCDH4072	400	721	881	3007	£335.00	£419.00	£402.00	£502.80
VOLCDH5272	520	721	1159	3956	£385.00	£482.00	£462.00	£578.40
VOLCDH6072	600	721	1320	4505	£441.00	£551.00	£529.20	£661.20
VOLCDH3297	320	971	920	3140	£354.00	£442.00	£424.80	£530.40
VOLCDH4097	400	971	1145	3908	£437.00	£546.00	£524.40	£655.20
VOLCDH5297	520	971	1494	5099	£512.00	£642.00	£614.40	£770.40
VOLCDH6097	600	971	1735	5922	£585.00	£732.00	£702.00	£878.40
VOLCDH7297	720	971	2150	7338	£674.00	£843.00	£808.80	£1,011.60
VOLCDH8097	800	971	2428	8287	£759.00	£949.00	£910.80	£1,138.80
VOLCDH3214	320	1471	1339	4570	£406.00	£508.00	£487.20	£609.60
VOLCDH4014	400	1471	1680	5734	£500.00	£626.00	£600.00	£751.20
VOLCDH5214	520	1471	2196	7495	£645.00	£805.00	£774.00	£966.00
VOLCDH6014	600	1471	2517	8591	£772.00	£965.00	£926.40	£1,158.00
VOLCDH7214	720	1471	3006	10259	£817.00	£1,022.00	£980.40	£1,226.40
VOLCDH4017	400	1771	1991	6795	£614.00	£769.00	£736.80	£922.80
VOLCDH5217	520	1771	2685	9164	£810.00	£1,012.00	£972.00	£1,214.40
VOLCDH6017	600	1771	3180	10853	£959.00	£1,198.00	£1,150.80	£1,437.60
VOLCDH8017	800	1771	4339	14809	£1,079.00	£1,350.00	£1,294.80	£1,620.00
VOLCDH4019	400	1971	2204	7522	£691.00	£864.00	£829.20	£1,036.80
VOLCDH5219	520	1971	3009	10270	£832.00	£1,040.00	£998.40	£1,248.00
VOLCDH8019	800	1971	4825	16468	£1,158.00	£1,448.00	£1,389.60	£1,737.60

Volcano horizontal	Pipe centres left to right	Pipe centres from wall	Depth from wall
Volcano horizontal single	width - 36mm	70mm - 75mm	107mm - 112mm
Volcano horizontal double	width - 36mm	52mm	90mm

Automatic bleed valve included with these radiators

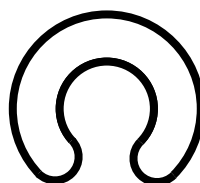

Actual tube size 26mm

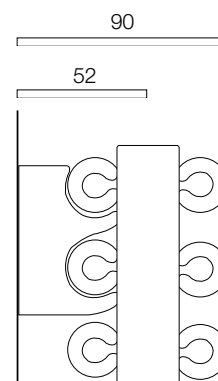
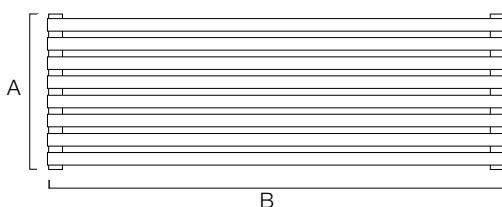
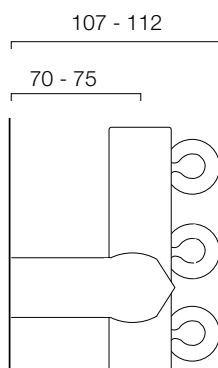

Volcano Vertical shown on pages 14 - 15



All stocked radiators have prices listed in purple and will be delivered in 3 - 5 working days.

Volcano Single Vertical

Model	Height A (mm)	Width B (mm)	Watts Δt 50°C	Btu's Δt 50°C	White Ex VAT	Colours Ex VAT	White Inc VAT	Colours Inc VAT
VOLCSV5732	571	320	345	1177	£207.00	£259.00	£248.40	£310.80
VOLCSV5740	571	400	430	1468	£238.00	£298.00	£285.60	£357.60
VOLCSV5752	571	520	552	1884	£258.00	£323.00	£309.60	£387.60
VOLCSV7232	721	320	424	1447	£237.00	£296.00	£284.40	£355.20
VOLCSV7240	721	400	529	1805	£275.00	£344.00	£330.00	£412.80
VOLCSV7252	721	520	695	2372	£305.00	£381.00	£366.00	£457.20
VOLCSV7260	721	600	792	2703	£331.00	£413.00	£397.20	£495.60
VOLCSV9732	971	320	550	1877	£267.00	£333.00	£320.40	£399.60
VOLCSV9740	971	400	687	2345	£322.00	£402.00	£386.40	£482.40
VOLCSV9752	971	520	896	3058	£356.00	£445.00	£427.20	£534.00
VOLCSV9760	971	600	1040	3550	£394.00	£492.00	£472.80	£590.40
VOLCSV9772	971	720	1289	4399	£441.00	£551.00	£529.20	£661.20
VOLCSV9780	971	800	1457	4973	£508.00	£635.00	£609.60	£762.00
VOLCSV1432	1471	320	803	2741	£317.00	£397.00	£380.40	£476.40
VOLCSV1440	1471	400	1008	3440	£377.00	£471.00	£452.40	£565.20
VOLCSV1452	1471	520	1317	4495	£462.00	£578.00	£554.40	£693.60
VOLCSV1460	1471	600	1510	5154	£539.00	£673.00	£646.80	£807.60
VOLCSV1472	1471	720	1947	6645	£565.00	£707.00	£678.00	£848.40
VOLCSV1732	1771	320	957	3266	£377.00	£471.00	£452.40	£565.20
VOLCSV1740	1771	400	1195	4079	£437.00	£546.00	£524.40	£655.20
VOLCSV1752	1771	520	1610	5495	£551.00	£689.00	£661.20	£826.80
VOLCSV1760	1771	600	1908	6512	£662.00	£826.00	£794.40	£991.20
VOLCSV1772	1771	720	2313	7894	£716.00	£896.00	£859.20	£1,075.20
VOLCSV1780	1771	800	2603	8884	£722.00	£903.00	£866.40	£1,083.60
VOLCSV1932	1971	320	1059	3614	£415.00	£519.00	£498.00	£622.80
VOLCSV1940	1971	400	1323	4515	£479.00	£599.00	£574.80	£718.80
VOLCSV1952	1971	520	1805	6160	£572.00	£715.00	£686.40	£858.00
VOLCSV1960	1971	600	2077	7089	£649.00	£811.00	£778.80	£973.20
VOLCSV1972	1971	720	2580	8806	£759.00	£948.00	£910.80	£1,137.60
VOLCSV1980	1971	800	2895	9881	£769.00	£961.00	£922.80	£1,153.20

Volcano Double Vertical

Model	Height A (mm)	Width B (mm)	Watts Δt 50°C	Btu's Δt 50°C	White Ex VAT	Colours Ex VAT	White Inc VAT	Colours Inc VAT
VOLCDV5732	571	320	577	1969	£221.00	£275.00	£265.20	£330.00
VOLCDV5740	571	400	717	2447	£268.00	£335.00	£321.60	£402.00
VOLCDV5752	571	520	922	3147	£305.00	£381.00	£366.00	£457.20
VOLCDV7232	721	320	708	2416	£279.00	£350.00	£334.80	£420.00
VOLCDV7240	721	400	881	3007	£335.00	£419.00	£402.00	£502.80
VOLCDV7252	721	520	1159	3956	£385.00	£482.00	£462.00	£578.40
VOLCDV7260	721	600	1320	4505	£441.00	£551.00	£529.20	£661.20
VOLCDV9732	971	320	917	3130	£348.00	£435.00	£417.60	£522.00
VOLCDV9740	971	400	1145	3908	£437.00	£546.00	£524.40	£655.20
VOLCDV9752	971	520	1494	5099	£512.00	£642.00	£614.40	£770.40
VOLCDV9760	971	600	1735	5922	£585.00	£732.00	£702.00	£878.40
VOLCDV9772	971	720	2150	7338	£674.00	£843.00	£808.80	£1,011.60
VOLCDV9780	971	800	2428	8287	£759.00	£949.00	£910.80	£1,138.80
VOLCDV1432	1471	320	1339	4570	£406.00	£508.00	£487.20	£609.60
VOLCDV1440	1471	400	1680	5734	£500.00	£626.00	£600.00	£751.20
VOLCDV1452	1471	520	2196	7495	£645.00	£805.00	£774.00	£966.00
VOLCDV1460	1471	600	2517	8591	£772.00	£965.00	£926.40	£1,158.00
VOLCDV1472	1471	720	3246	11079	£812.00	£1,014.00	£974.40	£1,216.80
VOLCDV1732	1771	320	1595	5444	£504.00	£631.00	£604.80	£757.20
VOLCDV1740	1771	400	1991	6795	£614.00	£769.00	£736.80	£922.80
VOLCDV1752	1771	520	2685	9164	£810.00	£1,012.00	£972.00	£1,214.40
VOLCDV1760	1771	600	3180	10853	£959.00	£1,198.00	£1,150.80	£1,437.60
VOLCDV1772	1771	720	3854	13154	£1,065.00	£1,330.00	£1,278.00	£1,596.00
VOLCDV1780	1771	800	4339	14809	£1,260.00	£1,575.00	£1,512.00	£1,890.00
VOLCDV1932	1971	320	1766	6027	£568.00	£710.00	£681.60	£852.00
VOLCDV1940	1971	400	2204	7522	£691.00	£864.00	£829.20	£1,036.80
VOLCDV1952	1971	520	3009	10270	£832.00	£1,040.00	£998.40	£1,248.00
VOLCDV1960	1971	600	3461	11812	£954.00	£1,193.00	£1,144.80	£1,431.60
VOLCDV1972	1971	720	4301	14679	£1,141.00	£1,426.00	£1,369.20	£1,711.20
VOLCDV1980	1971	800	4825	16468	£1,153.00	£1,441.00	£1,383.60	£1,729.20

Volcano vertical	Pipe centres left to right	Pipe centres from wall	Depth from wall
Volcano vertical single	width + valves	55mm	98mm
Volcano vertical double	width + valves	55mm	98mm

Automatic bleed valve included with these radiators

Underneath Connections	Ex VAT	Inc VAT
B2CONN	£91.00	£109.20

Underneath Connections are made to order only, stock lines are BOE.
Underneath Connections pipe centres = width - 82mm

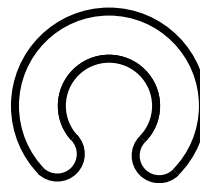

Actual tube size 26mm

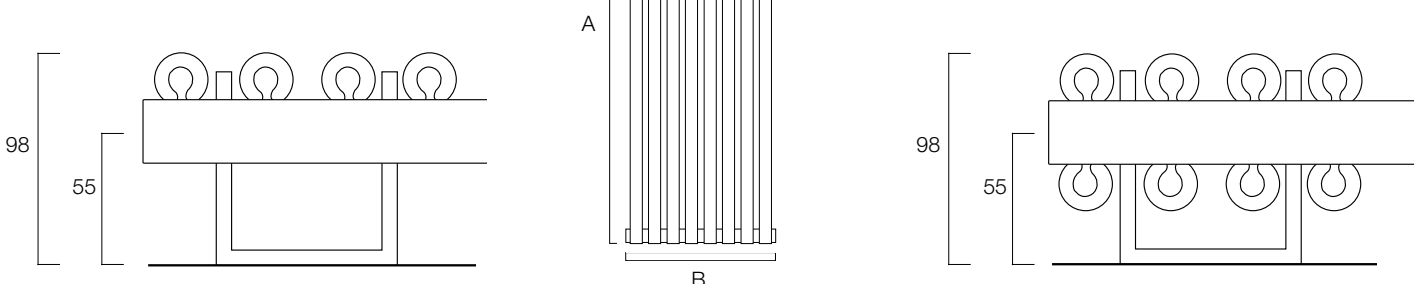

TRC 13 Horizontal shown on page 16



All stocked radiators have prices listed in purple and will be delivered in 3 - 5 working days.

TRC 13 Single Horizontal

Model	Height A (mm)	Width B (mm)	Watts Δt 50°C	Btu's Δt 50°C	White Ex VAT	Colours Ex VAT	White Inc VAT	Colours Inc VAT
TR13SH4410	440	1000	577	1969	£247.00	£309.00	£296.40	£370.80
TR13SH5110	512	1000	676	2307	£276.00	£345.00	£331.20	£414.00
TR13SH5810	584	1000	774	2642	£286.00	£358.00	£343.20	£429.60
TR13SH4414	440	1400	808	2758	£323.00	£404.00	£387.60	£484.80
TR13SH5114	512	1400	947	3232	£360.00	£451.00	£432.00	£541.20
TR13SH5814	584	1400	1083	3696	£375.00	£469.00	£450.00	£562.80
TR13SH5118	512	1800	1217	4154	£451.00	£564.00	£541.20	£676.80
TR13SH5818	584	1800	1387	4734	£465.00	£627.00	£558.00	£752.40
TR13SH4420	440	2000	1156	3945	£435.00	£544.00	£522.00	£652.80
TR13SH5120	512	2000	1352	4614	£487.00	£608.00	£584.40	£729.60
TR13SH5820	584	2000	1547	5280	£504.00	£631.00	£604.80	£757.20

TRC 13 Double Horizontal

Model	Height A (mm)	Width B (mm)	Watts Δt 50°C	Btu's Δt 50°C	White Ex VAT	Colours Ex VAT	White Inc VAT	Colours Inc VAT
TR13DH4410	440	1000	957	3266	£488.00	£610.00	£585.60	£732.00
TR13DH5110	512	1000	1103	3765	£546.00	£683.00	£655.20	£819.60
TR13DH5810	584	1000	1247	4256	£624.00	£780.00	£748.80	£936.00
TR13DH4414	440	1400	1339	4570	£640.00	£801.00	£768.00	£961.20
TR13DH5114	512	1400	1544	5270	£716.00	£896.00	£859.20	£1,075.20
TR13DH5814	584	1400	1745	5956	£818.00	£1,023.00	£981.60	£1,227.60
TR13DH5118	512	1800	1985	6775	£896.00	£1,120.00	£1,075.20	£1,344.00
TR13DH5818	584	1800	2244	7659	£954.00	£1,193.00	£1,144.80	£1,431.60
TR13DH4420	440	2000	1913	6529	£804.00	£1,004.00	£964.80	£1,204.80
TR13DH5120	512	2000	2206	7529	£964.00	£1,205.00	£1,156.80	£1,446.00
TR13DH5820	584	2000	2493	8509	£1,102.00	£1,377.00	£1,322.40	£1,652.40

TRC 13 Single Horizontal, Chrome / Nickel

Model	Height A (mm)	Width B (mm)	Watts Δt 50°C	Btu's Δt 50°C	Chrome/Nickel Ex VAT	Chrome/Nickel Inc VAT
TR13SH3910C/N	392	1000	453	1546	£1,027.00	£1,232.40
TR13SH4810C/N	488	1000	572	1952	£1,101.00	£1,321.20
TR13SH5810C/N	584	1000	689	2352	£1,120.00	£1,344.00
TR13SH3915C/N	392	1500	680	2321	£1,407.00	£1,688.40
TR13SH4815C/N	488	1500	858	2928	£1,510.00	£1,812.00
TR13SH5815C/N	584	1500	1033	3526	£1,535.00	£1,842.00
TR13SH3920C/N	392	2000	907	3096	£1,810.00	£2,172.00
TR13SH4820C/N	488	2000	1145	3908	£1,938.00	£2,325.60
TR13SH5820C/N	584	2000	1377	4700	£1,971.00	£2,365.20

TRC 13 horizontal	Pipe centres left to right	Pipe centres from wall	Depth from wall
TRC 13 single horizontal	width - 40mm	54mm	80mm
TRC 13 double horizontal	width - 40mm	54mm	80mm

Automatic bleed valve included with these radiators

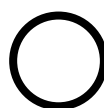

Actual tube size 13mm

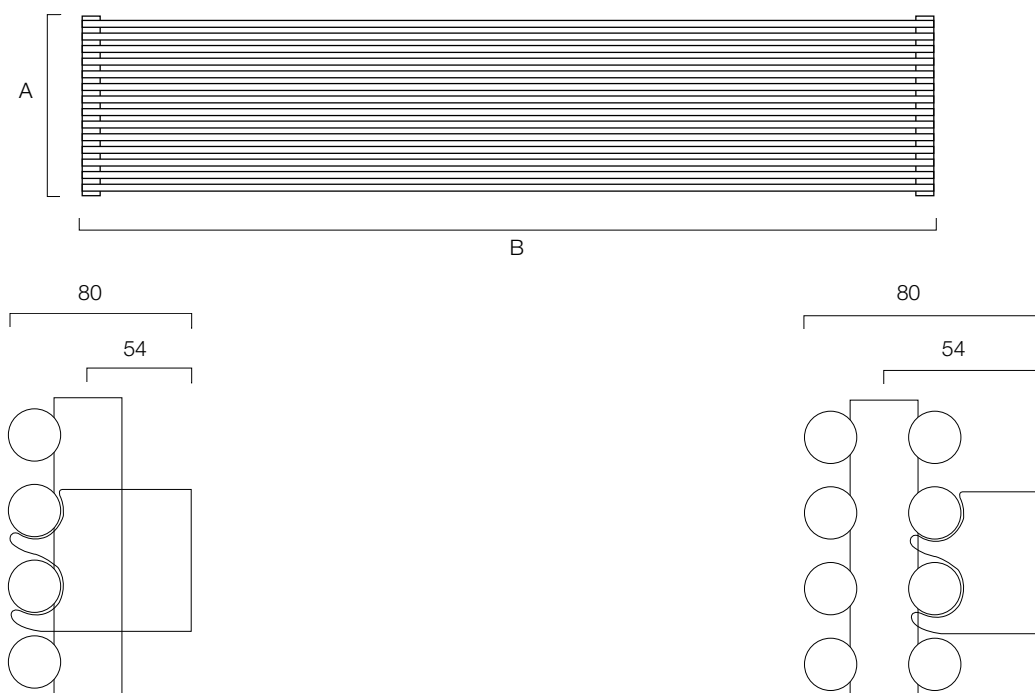

Non stock radiators are bespoke & made to order. Delivery times may be extended during factory holiday closures in Jul/Aug & Dec. Delivery times will be confirmed at time of order.

TRC 13 Vertical shown on page 16



All stocked radiators have prices listed in purple and will be delivered in 3 - 5 working days.

TRC 13 Single Vertical

Model	Height A (mm)	Width B (mm)	Watts Δt 50°C	Btu's Δt 50°C	White Ex VAT	Colours Ex VAT	White Inc VAT	Colours Inc VAT
TR13SV1044	1000	440	571	1949	£247.00	£309.00	£296.40	£370.80
TR13SV1051	1000	512	667	2276	£276.00	£345.00	£331.20	£414.00
TR13SV1058	1000	584	762	2601	£286.00	£358.00	£343.20	£429.60
TR13SV1244	1200	440	670	2287	£292.00	£366.00	£350.40	£439.20
TR13SV1251	1200	512	781	2666	£326.00	£408.00	£391.20	£489.60
TR13SV1258	1200	584	893	3048	£339.00	£424.00	£406.80	£508.80
TR13SV1544	1500	440	820	2799	£338.00	£422.00	£405.60	£506.40
TR13SV1551	1500	512	957	3266	£378.00	£473.00	£453.60	£567.60
TR13SV1558	1500	584	1094	3734	£393.00	£491.00	£471.60	£589.20
TR13SV1844	1800	440	967	3300	£404.00	£505.00	£484.80	£606.00
TR13SV1851	1800	512	1128	3850	£451.00	£564.00	£541.20	£676.80
TR13SV1858	1800	584	1289	4399	£465.00	£627.00	£558.00	£752.40
TR13SV2044	2000	440	1063	3628	£435.00	£544.00	£522.00	£662.80
TR13SV2051	2000	512	1240	4232	£487.00	£608.00	£584.40	£729.60
TR13SV2058	2000	584	1418	4840	£504.00	£631.00	£604.80	£757.20

TRC 13 Double Vertical

Model	Height A (mm)	Width B (mm)	Watts Δt 50°C	Btu's Δt 50°C	White Ex VAT	Colours Ex VAT	White Inc VAT	Colours Inc VAT
TR13DV1044	1000	440	837	2857	£459.00	£574.00	£550.80	£688.80
TR13DV1051	1000	512	977	3335	£546.00	£683.00	£655.20	£819.60
TR13DV1058	1000	584	1116	3809	£624.00	£780.00	£748.80	£936.00
TR13DV1244	1200	440	988	3372	£582.00	£728.00	£698.40	£873.60
TR13DV1251	1200	512	1153	3935	£652.00	£815.00	£782.40	£978.00
TR13DV1258	1200	584	1317	4495	£744.00	£930.00	£892.80	£1,116.00
TR13DV1544	1500	440	1208	4123	£671.00	£839.00	£805.20	£1,006.80
TR13DV1551	1500	512	1409	4809	£750.00	£938.00	£900.00	£1,125.60
TR13DV1558	1500	584	1610	5495	£857.00	£1,072.00	£1,028.40	£1,286.40
TR13DV1844	1800	440	1421	4850	£801.00	£1,001.00	£961.20	£1,201.20
TR13DV1851	1800	512	1658	5659	£896.00	£1,120.00	£1,075.20	£1,344.00
TR13DV1858	1800	584	1895	6468	£954.00	£1,193.00	£1,144.80	£1,431.60
TR13DV2044	2000	440	1561	5328	£862.00	£1,078.00	£1,034.40	£1,293.60
TR13DV2051	2000	512	1822	6218	£964.00	£1,205.00	£1,156.80	£1,446.00
TR13DV2058	2000	584	2082	7106	£1,102.00	£1,377.00	£1,322.40	£1,652.40

TRC 13 Single Vertical, Chrome / Nickel

Model	Height A (mm)	Width B (mm)	Watts Δt 50°C	Btu's Δt 50°C	Chrome/Nickel Ex VAT	Chrome/Nickel Inc VAT
TR13SV1039C/N	1000	392	452	1543	£1,027.00	£1,232.40
TR13SV1048C/N	1000	488	565	1928	£1,101.00	£1,321.20
TR13SV1058C/N	1000	584	678	2314	£1,120.00	£1,344.00
TR13SV1539C/N	1500	392	649	2215	£1,407.00	£1,688.40
TR13SV1548C/N	1500	488	811	2768	£1,510.00	£1,812.00
TR13SV1558C/N	1500	584	974	3324	£1,535.00	£1,842.00
TR13SV2039C/N	2000	392	841	2870	£1,810.00	£2,172.00
TR13SV2048C/N	2000	488	1051	3587	£1,938.00	£2,325.60
TR13SV2058C/N	2000	584	1262	4307	£1,971.00	£2,365.20

TRC 13 vertical	Pipe centres left to right	Pipe centres from wall	Depth from wall
TRC 13 single vertical	width + valves	54mm	80mm
TRC 13 double vertical	width + valves	54mm	80mm

Automatic bleed valve included with these radiators

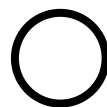

Actual tube size 13mm

Underneath Connections	Ex VAT	Inc VAT
B2CONN	£91.00	£109.20

Underneath Connections are made to order only, stock lines are BOE.

Underneath Connections pipe centres = width - 58mm

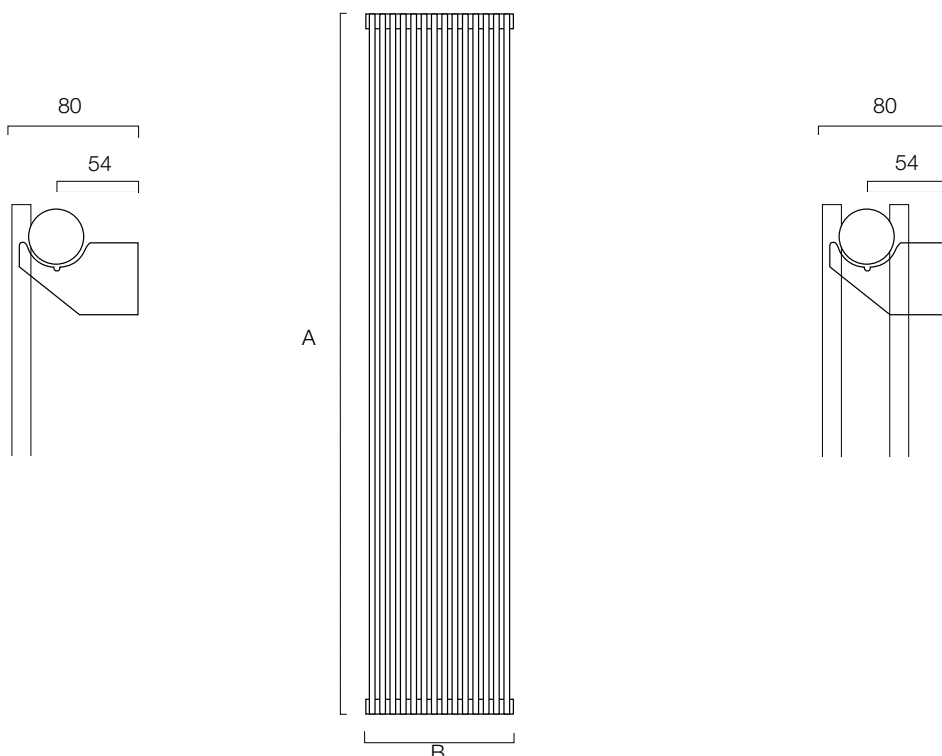

TRC 16 Horizontal shown on page 17



All stocked radiators have prices listed in purple and will be delivered in 3 - 5 working days.

TRC 16 Single Horizontal

Model	Height A (mm)	Width B (mm)	Watts At 50°C	Btu's At 50°C	White Ex VAT	Colours Ex VAT	White Inc VAT	Colours Inc VAT
TR16SH2771	278	710	267	911	£211.00	£285.00	£253.20	£342.00
TR16SH4571	453	710	437	1491	£242.00	£326.00	£290.40	£391.20
TR16SH5571	553	710	534	1822	£273.00	£368.00	£327.60	£441.60
TR16SH2710	278	1010	377	1286	£230.00	£311.00	£276.00	£373.20
TR16SH4510	453	1010	617	2105	£257.00	£347.00	£308.40	£416.40
TR16SH5510	553	1010	754	2573	£291.00	£393.00	£349.20	£471.60
TR16SH2712	278	1210	452	1542	£246.00	£333.00	£295.20	£399.60
TR16SH4512	453	1210	740	2525	£284.00	£383.00	£340.80	£459.60
TR16SH5512	553	1210	905	3088	£329.00	£444.00	£394.80	£532.80
TR16SH2218	228	1810	554	1891	£319.00	£433.00	£382.80	£519.60
TR16SH2718	278	1810	677	2310	£329.00	£445.00	£394.80	£534.00
TR16SH3218	328	1810	800	2730	£351.00	£474.00	£421.20	£568.80
TR16SH4518	453	1810	1108	3780	£378.00	£510.00	£453.60	£612.00
TR16SH5518	553	1810	1354	4620	£441.00	£595.00	£529.20	£714.00
TR16SH2720	278	2010	752	2566	£346.00	£467.00	£415.20	£560.40
TR16SH4520	453	2010	1230	4197	£405.00	£547.00	£486.00	£656.40
TR16SH5520	553	2010	1504	5132	£470.00	£634.00	£564.00	£760.80

TRC 16 Double Horizontal

Model	Height A (mm)	Width B (mm)	Watts At 50°C	Btu's At 50°C	White Ex VAT	Colours Ex VAT	White Inc VAT	Colours Inc VAT
TR16DH2771	278	710	443	1512	£407.00	£550.00	£488.40	£660.00
TR16DH4571	453	710	725	2474	£465.00	£628.00	£558.00	£753.60
TR16DH5571	553	710	886	3023	£524.00	£707.00	£628.80	£848.40
TR16DH2710	278	1010	627	2139	£447.00	£603.00	£536.40	£723.60
TR16DH4510	453	1010	1026	3501	£494.00	£668.00	£592.80	£801.60
TR16DH5510	553	1010	1254	4279	£561.00	£757.00	£673.20	£908.40
TR16DH2712	278	1210	752	2566	£476.00	£643.00	£571.20	£771.60
TR16DH4512	453	1210	1231	4200	£546.00	£738.00	£655.20	£885.60
TR16DH5512	553	1210	1505	5135	£633.00	£855.00	£759.60	£1,026.00
TR16DH2218	228	1810	919	3137	£611.00	£824.00	£733.20	£988.80
TR16DH2718	278	1810	1124	3835	£635.00	£858.00	£762.00	£1,029.60
TR16DH3218	328	1810	1328	4532	£668.00	£901.00	£801.60	£1,081.20
TR16DH4518	453	1810	1839	6275	£728.00	£982.00	£873.60	£1,178.40
TR16DH5518	553	1810	2248	7670	£848.00	£1,145.00	£1,017.60	£1,374.00
TR16DH2720	278	2010	1251	4268	£667.00	£900.00	£800.40	£1,080.00
TR16DH4520	453	2010	2047	6984	£780.00	£1,053.00	£936.00	£1,263.60
TR16DH5520	553	2010	2501	8533	£903.00	£1,220.00	£1,083.60	£1,464.00

TRC 16 horizontal	Pipe centres left to right	Pipe centres from wall	Depth from wall
TRC 16 single horizontal	width - 50mm	30mm - 40mm	65mm - 75mm
TRC 16 double horizontal	width - 50mm	80mm - 90mm	111mm - 121mm

Automatic bleed valve included with these radiators

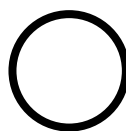

Actual tube size 16mm

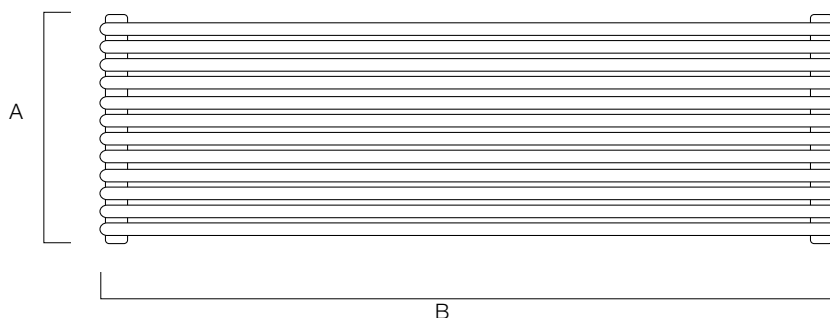
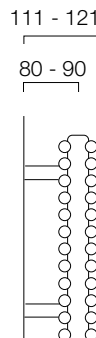
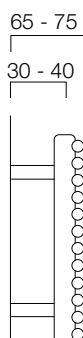

Non stock radiators are bespoke & made to order. Delivery times may be extended during factory holiday closures in Jul/Aug & Dec. Delivery times will be confirmed at time of order.

TRC 16 Vertical shown on page 17



All stocked radiators have prices listed in purple and will be delivered in 3 - 5 working days.

TRC 16 Single Vertical

Model	Height A (mm)	Width B (mm)	Watts Δt 50°C	Btu's Δt 50°C	White Ex VAT	Colours Ex VAT	White Inc VAT	Colours Inc VAT
TR16SV7122	710	228	221	754	£191.00	£258.00	£229.20	£309.60
TR16SV7127	710	278	271	925	£199.00	£269.00	£238.80	£322.80
TR16SV7137	710	378	369	1259	£211.00	£285.00	£253.20	£342.00
TR16SV7145	710	453	443	1512	£227.00	£307.00	£272.40	£368.40
TR16SV7155	710	553	541	1846	£257.00	£347.00	£308.40	£416.40
TR16SV9122	910	228	278	949	£201.00	£272.00	£241.20	£326.40
TR16SV9137	910	378	463	1580	£215.00	£291.00	£258.00	£349.20
TR16SV9145	910	453	556	1897	£236.00	£318.00	£283.20	£381.60
TR16SV9155	910	553	679	2317	£267.00	£361.00	£320.40	£433.20
TR16SV1222	1210	228	361	1232	£231.00	£312.00	£277.20	£374.40
TR16SV1227	1210	278	441	1505	£235.00	£317.00	£282.00	£380.40
TR16SV1237	1210	378	602	2054	£241.00	£326.00	£289.20	£391.20
TR16SV1245	1210	453	722	2463	£248.00	£335.00	£297.60	£402.00
TR16SV1255	1210	553	882	3009	£288.00	£389.00	£345.60	£466.80
TR16SV1822	1810	228	524	1788	£302.00	£408.00	£362.40	£489.60
TR16SV1827	1810	278	640	2184	£309.00	£417.00	£370.80	£500.40
TR16SV1832	1810	328	756	2580	£315.00	£425.00	£378.00	£510.00
TR16SV1837	1810	378	873	2979	£318.00	£429.00	£381.60	£514.80
TR16SV1845	1810	453	1047	3572	£356.00	£480.00	£427.20	£576.00
TR16SV1855	1810	553	1280	4367	£415.00	£560.00	£498.00	£672.00
TR16SV2022	2010	228	577	1969	£316.00	£427.00	£379.20	£512.40
TR16SV2037	2010	378	962	3282	£340.00	£460.00	£408.00	£552.00
TR16SV2045	2010	453	1155	3941	£381.00	£515.00	£457.20	£618.00
TR16SV2055	2010	553	1411	4814	£442.00	£597.00	£530.40	£716.40

TRC 16 Double Vertical

Model	Height A (mm)	Width B (mm)	Watts Δt 50°C	Btu's Δt 50°C	White Ex VAT	Colours Ex VAT	White Inc VAT	Colours Inc VAT
TR16DV7122	710	228	329	1123	£365.00	£492.00	£438.00	£590.40
TR16DV7127	710	278	402	1372	£378.00	£511.00	£453.60	£613.20
TR16DV7137	710	378	548	1870	£400.00	£540.00	£480.00	£648.00
TR16DV7145	710	453	658	2245	£433.00	£584.00	£519.60	£700.80
TR16DV7155	710	553	804	2743	£488.00	£658.00	£585.60	£789.60
TR16DV9122	910	228	412	1406	£384.00	£519.00	£460.80	£622.80
TR16DV9137	910	378	686	2341	£410.00	£554.00	£492.00	£664.80
TR16DV9145	910	453	824	2811	£448.00	£605.00	£537.60	£726.00
TR16DV9155	910	553	1007	3436	£508.00	£686.00	£609.60	£823.20
TR16DV1222	1210	228	535	1825	£422.00	£570.00	£506.40	£684.00
TR16DV1227	1210	278	653	2229	£442.00	£598.00	£530.40	£717.60
TR16DV1237	1210	378	891	3040	£457.00	£617.00	£548.40	£740.40
TR16DV1245	1210	453	1069	3647	£508.00	£686.00	£609.60	£823.20
TR16DV1255	1210	553	1307	4459	£589.00	£795.00	£706.80	£954.00
TR16DV1822	1810	228	778	2655	£572.00	£772.00	£686.40	£926.40
TR16DV1827	1810	278	951	3246	£580.00	£783.00	£696.00	£939.60
TR16DV1832	1810	328	1123	3833	£590.00	£796.00	£708.00	£955.20
TR16DV1837	1810	378	1296	4422	£609.00	£822.00	£730.80	£986.40
TR16DV1845	1810	453	1556	5309	£677.00	£914.00	£812.40	£1,096.80
TR16DV1855	1810	553	1901	6486	£789.00	£1,065.00	£946.80	£1,278.00
TR16DV2022	2010	228	859	2931	£602.00	£813.00	£722.40	£975.60
TR16DV2037	2010	378	1431	4883	£647.00	£874.00	£776.40	£1,048.80
TR16DV2045	2010	453	1718	5862	£725.00	£979.00	£870.00	£1,174.80
TR16DV2055	2010	553	2099	7162	£840.00	£1,134.00	£1,008.00	£1,360.80

TRC 16 vertical	Pipe centres left to right	Pipe centres from wall	Depth from wall
TRC 16 single vertical	width + valves	49mm	82mm
TRC 16 double vertical	width + valves	55mm	86mm

Automatic bleed valve included with these radiators

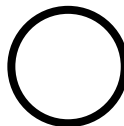

Actual tube size 16mm

Underneath Connections	Ex VAT	Inc VAT
B2CONN	£91.00	£109.20
Underneath Connections are made to order only, stock lines are BOE.		
Underneath Connections pipe centres = width - 75mm		

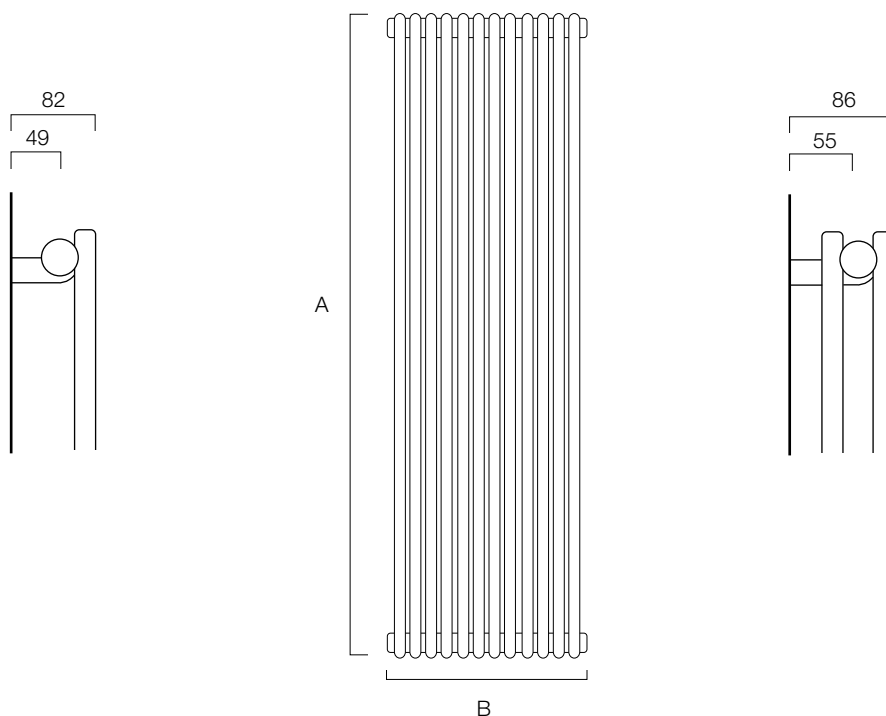

TRC 25 Horizontal shown on pages 18 - 19



All stocked radiators have prices listed in purple and will be delivered in 3 - 5 working days.

TRC 25 Single Horizontal

Model	Height A (mm)	Width B (mm)	Watts Δt 50°C	Btu's Δt 50°C	White Ex VAT	Colours Ex VAT	White Inc VAT	Colours Inc VAT
TR25SH2940	296	400	160	546	£101.00	£127.00	£121.20	£152.40
TR25SH3650	368	500	250	853	£111.00	£139.00	£133.20	£166.80
TR25SH5160	512	600	419	1430	£180.00	£235.00	£216.00	£282.00
TR25SH5860	584	600	479	1635	£201.00	£261.00	£241.20	£313.20
TR25SH6560	656	600	539	1840	£216.00	£281.00	£259.20	£337.20
TR25SH2970	296	700	279	952	£130.00	£163.00	£156.00	£195.60
TR25SH3670	368	700	349	1191	£153.00	£200.00	£183.60	£240.00
TR25SH5170	512	700	489	1669	£193.00	£241.00	£231.60	£289.20
TR25SH4410	440	1000	599	2044	£206.00	£267.00	£247.20	£320.40
TR25SH5110	512	1000	699	2386	£225.00	£293.00	£270.00	£351.60
TR25SH5810	584	1000	798	2724	£249.00	£324.00	£298.80	£388.80
TR25SH6510	656	1000	898	3065	£271.00	£353.00	£325.20	£423.60
TR25SH2912	296	1200	479	1635	£184.00	£230.00	£220.80	£276.00
TR25SH2914	296	1400	559	1908	£208.00	£270.00	£249.60	£324.00
TR25SH3614	368	1400	699	2386	£221.00	£287.00	£265.20	£344.40
TR25SH4414	440	1400	838	2860	£248.00	£323.00	£297.60	£387.60
TR25SH2918	296	1800	679	2317	£247.00	£321.00	£296.40	£385.20
TR25SH3618	368	1800	898	3065	£272.00	£367.00	£326.40	£440.40
TR25SH4418	440	1800	1078	3679	£288.00	£375.00	£345.60	£450.00
TR25SH5118	512	1800	1257	4290	£324.00	£421.00	£388.80	£505.20
TR25SH4420	440	2000	1198	4089	£308.00	£401.00	£369.60	£481.20
TR25SH5120	512	2000	1397	4768	£348.00	£453.00	£417.60	£543.60
TR25SH5820	584	2000	1597	5451	£389.00	£505.00	£466.80	£606.00
TR25SH6520	656	2000	1796	6130	£429.00	£558.00	£514.80	£669.60
TR25SH2922	296	2200	878	2997	£266.00	£332.00	£319.20	£398.40
TR25SH4422	440	2200	1317	4495	£327.00	£425.00	£392.40	£510.00

TRC 25 Double Horizontal

Model	Height A (mm)	Width B (mm)	Watts Δt 50°C	Btu's Δt 50°C	White Ex VAT	Colours Ex VAT	White Inc VAT	Colours Inc VAT
TR25DH2940	296	400	264	901	£155.00	£194.00	£186.00	£232.80
TR25DH3650	368	500	401	1369	£175.00	£219.00	£210.00	£262.80
TR25DH5160	512	600	652	2225	£307.00	£400.00	£368.40	£480.00
TR25DH5860	584	600	742	2532	£342.00	£445.00	£410.40	£534.00
TR25DH6560	656	600	830	2833	£364.00	£474.00	£436.80	£568.80
TR25DH2970	296	700	462	1577	£199.00	£248.00	£238.80	£297.60
TR25DH5170	512	700	760	2594	£326.00	£407.00	£391.20	£488.40
TR25DH3670	368	700	562	1918	£268.00	£335.00	£321.60	£402.00
TR25DH4410	440	1000	946	3229	£348.00	£453.00	£417.60	£543.60
TR25DH5110	512	1000	1086	3707	£382.00	£496.00	£458.40	£595.20
TR25DH5810	584	1000	1236	4218	£421.00	£548.00	£505.20	£657.60
TR25DH6510	656	1000	1383	4720	£461.00	£600.00	£553.20	£720.00
TR25DH2912	296	1200	791	2700	£299.00	£374.00	£358.80	£448.80
TR25DH2914	296	1400	923	3150	£352.00	£457.00	£422.40	£548.40
TR25DH3614	368	1400	1123	3833	£374.00	£487.00	£448.80	£584.40
TR25DH4414	440	1400	1324	4519	£423.00	£550.00	£507.60	£660.00
TR25DH2918	296	1800	1187	4051	£405.00	£527.00	£486.00	£632.40
TR25DH3618	368	1800	1444	4928	£440.00	£594.00	£528.00	£712.80
TR25DH4418	440	1800	1702	5809	£492.00	£640.00	£590.40	£768.00
TR25DH5118	512	1800	1955	6672	£552.00	£718.00	£662.40	£861.60
TR25DH4420	440	2000	1891	6454	£524.00	£682.00	£628.80	£818.40
TR25DH5120	512	2000	2172	7413	£594.00	£772.00	£712.80	£926.40
TR25DH5820	584	2000	2473	8440	£662.00	£861.00	£794.40	£1,033.20
TR25DH6520	656	2000	2766	9440	£730.00	£949.00	£876.00	£1,138.80
TR25DH2922	296	2200	1450	4949	£446.00	£557.00	£535.20	£668.40
TR25DH4422	440	2200	2080	7099	£557.00	£724.00	£668.40	£868.80

TRC 25 horizontal	Pipe centres left to right	Pipe centres from wall	Depth from wall
TRC 25 single horizontal	width - 40mm	54mm	94mm
TRC 25 double horizontal	width - 40mm	54mm	94mm

Automatic bleed valve included with these radiators

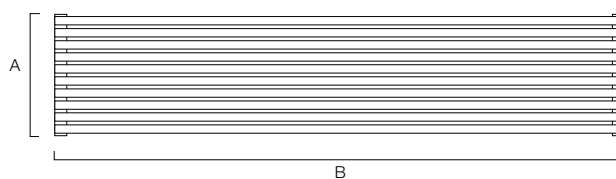
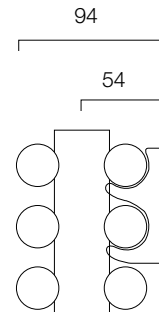
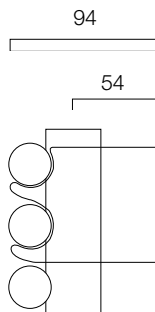
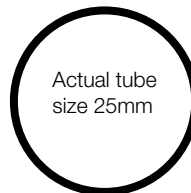

Non stock radiators are bespoke & made to order. Delivery times may be extended during factory holiday closures in Jul/Aug & Dec. Delivery times will be confirmed at time of order.

TRC 25 Vertical shown on pages 18 - 19



All stocked radiators have prices listed in purple and will be delivered in 3 - 5 working days.

TRC 25 Single Vertical

Model	Height A (mm)	Width B (mm)	Watts Δt 50°C	Btu's Δt 50°C	White Ex VAT	Colours Ex VAT	White Inc VAT	Colours Inc VAT
TR25SV4029	400	296	175	597	£101.00	£127.00	£121.20	£152.40
TR25SV5036	500	368	265	904	£106.00	£132.00	£127.20	£158.40
TR25SV5044	500	440	318	1085	£152.00	£198.00	£182.40	£237.60
TR25SV7029	700	296	286	976	£130.00	£163.00	£156.00	£195.60
TR25SV7036	700	368	358	1222	£155.00	£202.00	£186.00	£242.40
TR25SV7051	700	512	501	1710	£181.00	£227.00	£217.20	£272.40
TR25SV7058	700	584	573	1956	£209.00	£271.00	£250.80	£325.20
TR25SV1044	1000	440	593	2024	£206.00	£267.00	£247.20	£320.40
TR25SV1065	1000	656	889	3034	£268.00	£336.22	£321.60	£403.46
TR25SV1222	1200	224	350	1195	£167.00	£209.00	£200.40	£250.80
TR25SV1229	1200	296	467	1594	£184.00	£230.00	£220.80	£276.00
TR25SV1236	1200	368	584	1993	£200.00	£260.00	£240.00	£312.00
TR25SV1244	1200	440	701	2393	£228.00	£297.00	£273.60	£356.40
TR25SV1251	1200	512	818	2792	£253.00	£329.00	£303.60	£394.80
TR25SV1258	1200	584	934	3188	£281.00	£365.00	£337.20	£438.00
TR25SV1522	1500	224	419	1430	£181.00	£227.00	£217.20	£272.40
TR25SV1529	1500	296	558	1904	£216.00	£281.00	£259.20	£337.20
TR25SV1536	1500	368	698	2382	£228.00	£297.00	£273.60	£356.40
TR25SV1544	1500	440	838	2860	£259.00	£337.00	£310.80	£404.40
TR25SV1822	1800	224	481	1642	£216.00	£281.00	£259.20	£337.20
TR25SV1829	1800	296	641	2188	£239.00	£310.00	£286.80	£372.00
TR25SV1836	1800	368	801	2734	£253.00	£329.00	£303.60	£394.80
TR25SV1844	1800	440	961	3280	£288.00	£375.00	£345.60	£450.00
TR25SV1851	1800	512	1121	3826	£319.00	£415.00	£382.80	£498.00
TR25SV1858	1800	584	1282	4375	£351.00	£457.00	£421.20	£548.40
TR25SV2029	2000	296	706	2410	£251.00	£327.00	£301.20	£392.40
TR25SV2036	2000	368	883	3014	£270.00	£351.00	£324.00	£421.20
TR25SV2044	2000	440	1060	3618	£308.00	£401.00	£369.60	£481.20
TR25SV2051	2000	512	1236	4218	£348.00	£453.00	£417.60	£543.60
TR25SV2058	2000	584	1413	4823	£389.00	£505.00	£466.80	£606.00
TR25SV2065	2000	656	1589	5423	£422.00	£549.00	£506.40	£658.80
TR25SV2229	2200	296	772	2635	£266.00	£332.00	£319.20	£398.40
TR25SV2236	2200	368	965	3294	£277.00	£347.00	£332.40	£416.40
TR25SV2251	2200	512	1351	4611	£369.00	£480.00	£442.80	£576.00

TRC 25 Double Vertical

Model	Height A (mm)	Width B (mm)	Watts Δt 50°C	Btu's Δt 50°C	White Ex VAT	Colours Ex VAT	White Inc VAT	Colours Inc VAT
TR25DV4029	400	296	269	918	£155.00	£194.00	£186.00	£232.80
TR25DV5036	500	368	416	1420	£175.00	£219.00	£210.00	£262.80
TR25DV5044	500	440	499	1703	£258.00	£335.00	£309.60	£402.00
TR25DV7029	700	296	443	1512	£199.00	£248.00	£238.80	£297.60
TR25DV7036	700	368	544	1857	£268.00	£348.00	£321.60	£417.60
TR25DV7051	700	512	776	2648	£310.00	£418.00	£372.00	£501.60
TR25DV7058	700	584	886	3024	£355.00	£461.00	£426.00	£553.20
TR25DV1044	1000	440	899	3068	£348.00	£453.00	£417.60	£543.60
TR25DV1065	1000	656	1348	4601	£440.00	£550.00	£528.00	£660.00
TR25DV1222	1200	224	524	1788	£293.00	£367.00	£351.60	£440.40
TR25DV1229	1200	296	699	2386	£315.00	£425.00	£378.00	£510.00
TR25DV1236	1200	368	874	2983	£341.00	£443.00	£409.20	£531.60
TR25DV1244	1200	440	1049	3580	£389.00	£505.00	£466.80	£606.00
TR25DV1251	1200	512	1224	4178	£429.00	£558.00	£514.80	£669.60
TR25DV1258	1200	584	1398	4771	£478.00	£621.00	£573.60	£745.20
TR25DV1522	1500	224	633	2160	£316.00	£396.00	£379.20	£475.20
TR25DV1529	1500	296	844	2881	£367.00	£478.00	£440.40	£573.60
TR25DV1536	1500	368	1055	3601	£389.00	£505.00	£466.80	£606.00
TR25DV1544	1500	440	1266	4321	£442.00	£574.00	£530.40	£688.80
TR25DV1822	1800	224	703	2399	£383.00	£498.00	£459.60	£597.60
TR25DV1829	1800	296	1006	3433	£405.00	£527.00	£486.00	£632.40
TR25DV1836	1800	368	1258	4294	£430.00	£559.00	£516.00	£670.80
TR25DV1844	1800	440	1510	5154	£455.00	£592.00	£546.00	£710.40
TR25DV1851	1800	512	1761	6010	£479.00	£623.00	£574.80	£747.60
TR25DV1858	1800	584	2013	6870	£505.00	£656.00	£606.00	£787.20
TR25DV2029	2000	296	1074	3666	£427.00	£556.00	£512.40	£667.20
TR25DV2036	2000	368	1343	4584	£457.00	£594.00	£548.40	£712.80
TR25DV2044	2000	440	1612	5502	£524.00	£682.00	£628.80	£818.40
TR25DV2051	2000	512	1880	6416	£594.00	£772.00	£712.80	£926.40
TR25DV2058	2000	584	2149	7335	£662.00	£861.00	£794.40	£1,033.20
TR25DV2065	2000	656	2417	8249	£730.00	£949.00	£876.00	£1,138.80
TR25DV2229	2200	296	1163	3969	£446.00	£557.00	£535.20	£668.40
TR25DV2236	2200	368	1454	4963	£479.00	£599.00	£574.80	£718.80
TR25DV2251	2200	512	2036	6949	£628.00	£816.00	£753.60	£979.20

TRC 25 vertical	Pipe centres left to right	Pipe centres from wall	Depth from wall
TRC 25 single vertical	width + valves	54mm	94mm
TRC 25 double vertical	width + valves	54mm	94mm

Automatic bleed valve included with these radiators

Underneath Connections	Ex VAT	Inc VAT
B2CONN	£91.00	£109.20

Underneath Connections are made to order only, stock lines are BOE.
Underneath Connections pipe centres = width - 80mm

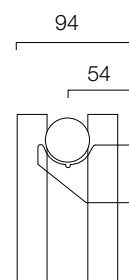
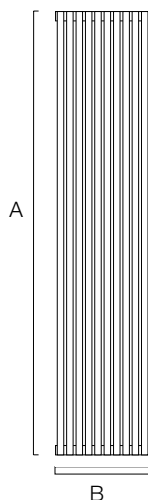
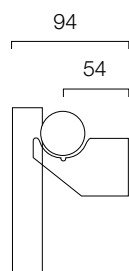
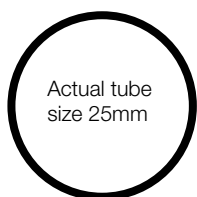

Vision 25 shown on page 20



All stocked radiators have prices listed in purple and will be delivered in 3 - 5 working days.

Vision 25 Single

Model	Height A (mm)	Width B (mm)	Watts Δt 50°C	Btu's Δt 50°C	White Ex VAT	Colours Ex VAT	White Inc VAT	Colours Inc VAT
VI25S1744	1700	440	1078	3679	£755.00	£944.00	£906.00	£1,132.80
VI25S1751	1700	512	1257	4290	£809.00	£1,011.00	£970.80	£1,213.20
VI25S1758	1700	584	1437	4904	£843.00	£1,053.00	£1,011.60	£1,263.60
VI25S1765	1700	656	1616	5515	£895.00	£1,118.00	£1,074.00	£1,341.60
VI25S2044	2000	440	1252	4273	£796.00	£995.00	£955.20	£1,194.00
VI25S2051	2000	512	1460	4983	£859.00	£1,074.00	£1,030.80	£1,288.80
VI25S2058	2000	584	1669	5696	£896.00	£1,121.00	£1,075.20	£1,345.20
VI25S2065	2000	656	1877	6406	£956.00	£1,195.00	£1,147.20	£1,434.00

Vision 25	Pipe centres left to right	Pipe centres from wall	Depth from wall
Vision 25 single	width + valves	54mm	94mm
Vision 25 double	width + valves	54mm	94mm
Automatic bleed valve included with these radiators			

Vision 25 Double

Model	Height A (mm)	Width B (mm)	Watts Δt 50°C	Btu's Δt 50°C	White Ex VAT	Colours Ex VAT	White Inc VAT	Colours Inc VAT
VI25D1744	1700	440	1637	5587	£977.00	£1,222.00	£1,172.40	£1,466.40
VI25D1751	1700	512	1910	6519	£1,040.00	£1,300.00	£1,248.00	£1,560.00
VI25D1758	1700	584	2182	7447	£1,101.00	£1,376.00	£1,321.20	£1,651.20
VI25D1765	1700	656	2455	8379	£1,185.00	£1,482.00	£1,422.00	£1,778.40
VI25D2044	2000	440	1884	6430	£1,047.00	£1,309.00	£1,256.40	£1,570.80
VI25D2051	2000	512	2198	7502	£1,117.00	£1,397.00	£1,340.40	£1,676.40
VI25D2058	2000	584	2512	8573	£1,185.00	£1,482.00	£1,422.00	£1,778.40
VI25D2065	2000	656	2826	9645	£1,279.00	£1,598.00	£1,534.80	£1,917.60

Underneath Connections	Ex VAT	Inc VAT
B2CONN	£91.00	£109.20
Underneath Connections must be specified at time of order.		
Underneath Connections pipe centres = width - 80mm		

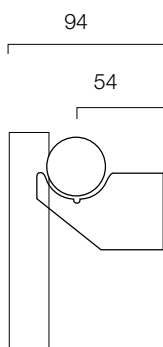

Mirrors

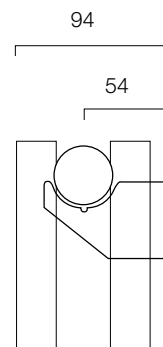
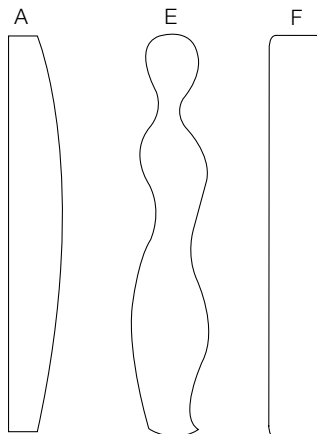

TRC 25 Chrome shown on pages 18 - 19



Model	Height A (mm)	Width B (mm)	Watts Δt 50°C	Btu's Δt 50°C	Chrome Ex VAT	Chrome Inc VAT
TR25SV1240C	1200	400	391	1335	£593.00	£711.60
TR25SV1248C	1200	480	470	1603	£683.00	£819.60
TR25SV1256C	1200	560	548	1871	£796.00	£955.20
TR25SV1540C	1500	400	468	1596	£647.00	£776.40
TR25SV1548C	1500	480	561	1916	£742.00	£890.40
TR25SV1556C	1500	560	655	2234	£868.00	£1,041.60
TR25SV1564C	1500	640	748	2554	£944.00	£1,132.80
TR25SV1832C	1800	320	429	1466	£679.00	£814.80
TR25SV1840C	1800	400	537	1832	£737.00	£884.40
TR25SV1848C	1800	480	644	2198	£845.00	£1,014.00
TR25SV1856C	1800	560	751	2563	£984.00	£1,180.80
TR25SV1864C	1800	640	859	2932	£1,074.00	£1,288.80
TR25SV2040C	2000	400	592	2019	£800.00	£960.00
TR25SV2052C	2000	520	769	2625	£998.00	£1,197.60
TR25SV2060C	2000	600	888	3030	£1,151.00	£1,381.20

TRC 25 Chrome	Pipe centres left to right	Pipe centres from wall	Depth from wall
TRC 25 Chrome	width + valves	54mm	94mm
Underneath Connections must be specified at time of order.			
Automatic bleed valve included with these radiators			

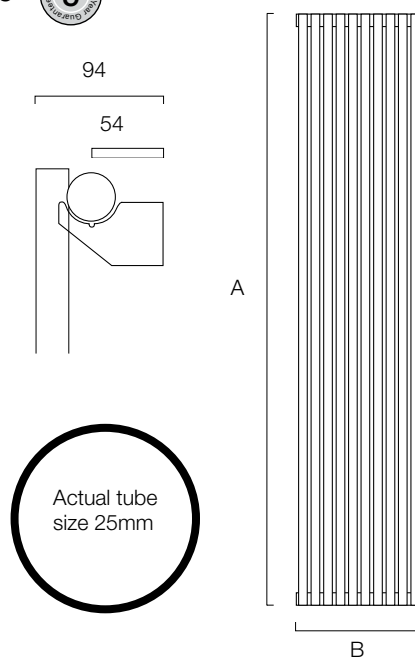

Underneath Connections	Ex VAT	Inc VAT
B2CONN	£91.00	£109.20
Underneath Connections are made to order only, stock lines are BOE.		
Underneath Connections pipe centres = width - 80mm		

Vivid shown on page 23



All stocked radiators have prices listed in purple and will be delivered in 3 - 5 working days.

Model	Height A (mm)	Width B (mm)	Watts Δt 50°C	Btu's Δt 50°C	White Ex VAT	Colours Ex VAT	White Inc VAT	Colours Inc VAT
VVIS6169	610	690	812	2771	£378.00	£473.00	£453.60	£567.60
VVIS6183	610	830	974	3324	£433.00	£542.00	£519.60	£650.40
VVIS6197	610	970	1137	3881	£490.00	£612.00	£588.00	£734.40
VVIS1234	1210	340	737	2515	£344.00	£430.00	£412.80	£516.00
VVIS1241	1210	410	884	3017	£392.00	£490.00	£470.40	£588.00
VVIS1248	1210	480	1032	3522	£440.00	£551.00	£528.00	£661.20
VVIS1255	1210	550	1179	4024	£489.00	£611.00	£586.80	£733.20
VVIS1527	1510	270	726	2478	£340.00	£425.00	£408.00	£510.00
VVIS1534	1510	340	907	3096	£403.00	£504.00	£483.60	£604.80
VVIS1541	1510	410	1088	3713	£461.00	£576.00	£553.20	£691.20
VVIS1827	1810	270	866	2956	£368.00	£460.00	£441.60	£552.00
VVIS1834	1810	340	1082	3693	£437.00	£547.00	£524.40	£656.40
VVIS1841	1810	410	1298	4430	£506.00	£632.00	£607.20	£758.40
VVIS1848	1810	480	1515	5171	£574.00	£718.00	£688.80	£861.60
VVIS1855	1810	550	1731	5908	£645.00	£806.00	£774.00	£967.20
VVIS2027	2010	270	962	3283	£409.00	£512.00	£490.80	£614.40
VVIS2034	2010	340	1203	4106	£489.00	£611.00	£586.80	£733.20
VVIS2041	2010	410	1444	4928	£561.00	£701.00	£673.20	£841.20
VVIS2048	2010	480	1684	5747	£641.00	£801.00	£769.20	£961.20
VVIS2055	2010	550	1925	6570	£719.00	£899.00	£862.80	£1,078.80

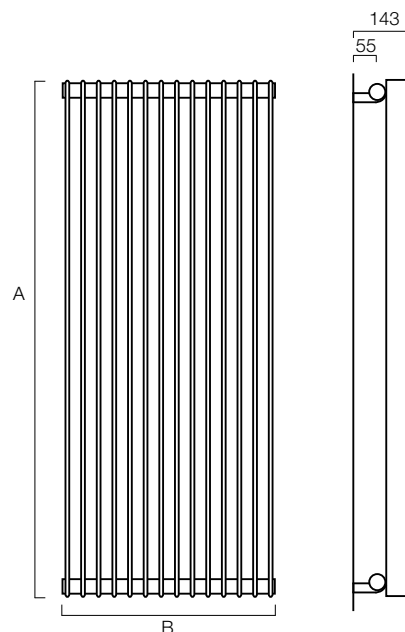

Vivid	Pipe centres left to right	Pipe centres from wall	Depth from wall
Vivid	width + valves	55mm	143mm
Automatic bleed valve included with these radiators			

Underneath Connections	Ex VAT	Inc VAT
B2CONN	£91.00	£109.20
Underneath Connections must be specified at time of order.		
Underneath Connections pipe centres = width - 75mm		

Water Lily shown on page 22



Model	Height A (mm)	Width B (mm)	Watts Δt 50°C	Btu's Δt 50°C	White Ex VAT	Colours Ex VAT	White Inc VAT	Colours Inc VAT
WLIL2015	2010	155	326	1112	£216.00	£270.00	£259.20	£324.00
WLIL2023	2010	230	489	1668	£240.00	£300.00	£288.00	£360.00
WLIL2030	2010	305	653	2228	£263.00	£329.00	£315.60	£394.80
WLIL2038	2010	380	816	2784	£293.00	£367.00	£351.60	£440.40
WLIL2045	2010	455	979	3341	£322.00	£402.00	£386.40	£482.40

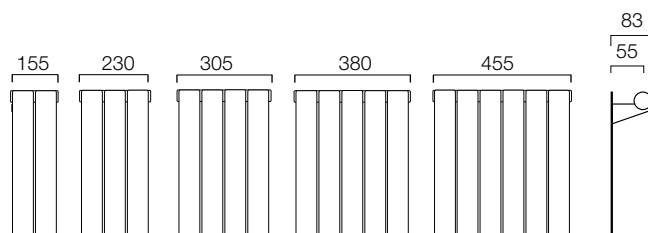

Water Lily	Pipe centres left to right	Pipe centres from wall	Depth from wall
Water Lily	width - 60mm	55mm	83mm
Please Note underneath connections only			
Automatic bleed valve included with these radiators			



TRC 35 shown on page 21



All stocked radiators have prices listed in purple and will be delivered in 3 - 5 working days.

TRC 35 Single Horizontal

Model	Height A (mm)	Width B (mm)	Watts Δt 50°C	Btu's Δt 50°C	White Ex VAT	Colours Ex VAT	White Inc VAT	Colours Inc VAT
TR35SH3415	344	1500	610	2082	£288.00	£360.00	£345.60	£432.00
TR35SH3417	344	1700	691	2358	£314.00	£393.00	£376.80	£471.60
TR35SH3419	344	1900	773	2638	£332.00	£415.00	£398.40	£498.00
TR35SH3915	392	1500	697	2379	£313.00	£391.00	£375.60	£469.20
TR35SH3917	392	1700	790	2696	£343.00	£429.00	£411.60	£514.80
TR35SH3919	392	1900	883	3014	£363.00	£454.00	£435.60	£544.80
TR35SH4815	488	1500	872	2976	£364.00	£455.00	£436.80	£546.00
TR35SH4817	488	1700	988	3372	£402.00	£503.00	£482.40	£603.60
TR35SH4819	488	1900	1104	3768	£427.00	£534.00	£512.40	£640.80
TR35SH5315	536	1500	959	3273	£391.00	£488.00	£469.20	£585.60
TR35SH5317	536	1700	1086	3707	£432.00	£540.00	£518.40	£648.00
TR35SH5319	536	1900	1214	4143	£460.00	£575.00	£552.00	£690.00

TRC 35	Pipe centres left to right	Pipe centres from wall	Depth from wall
TRC 35 single horizontal	width - 35mm	54mm	105mm
TRC 35 single vertical	width + valves	54mm	105 mm

Automatic bleed valve included with these radiators

single horizontal

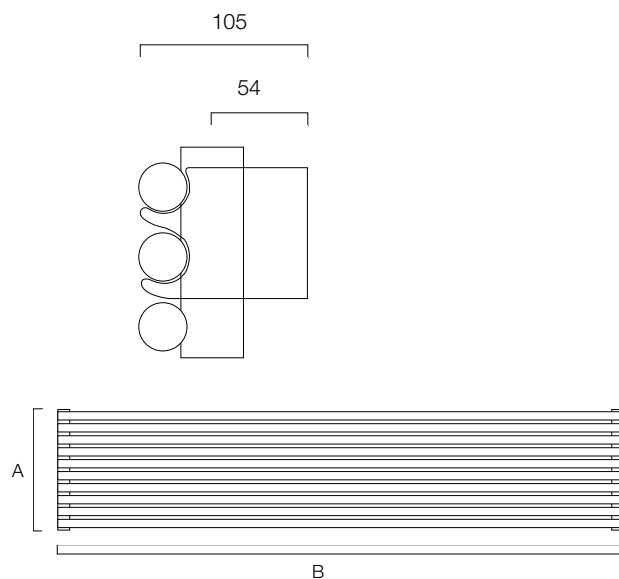

TRC 35 Single Vertical

Model	Height A (mm)	Width B (mm)	Watts Δt 50°C	Btu's Δt 50°C	White Ex VAT	Colours Ex VAT	White Inc VAT	Colours Inc VAT
TR35SV1534	1500	344	635	2167	£250.00	£312.00	£300.00	£374.40
TR35SV1539	1500	392	725	2474	£275.00	£344.00	£330.00	£412.80
TR35SV1548	1500	488	906	3092	£327.00	£408.00	£392.40	£489.60
TR35SV1553	1500	536	997	3403	£353.00	£441.00	£423.60	£529.20
TR35SV1734	1700	344	691	2358	£276.00	£345.00	£331.20	£414.00
TR35SV1739	1700	392	790	2696	£305.00	£382.00	£366.00	£458.40
TR35SV1748	1700	488	987	3369	£364.00	£455.00	£436.80	£546.00
TR35SV1753	1700	536	1086	3707	£394.00	£493.00	£472.80	£591.60
TR35SV1934	1900	344	765	2611	£294.00	£367.00	£352.80	£440.40
TR35SV1939	1900	392	875	2986	£325.00	£407.00	£390.00	£488.40
TR35SV1948	1900	488	1094	3734	£389.00	£487.00	£466.80	£584.40
TR35SV1953	1900	536	1203	4106	£422.00	£528.00	£506.40	£633.60

Underneath Connections	Ex VAT	Inc VAT
B2CONN	£91.00	£109.20
Underneath Connections are made to order only, stock lines are BOE.		
Underneath Connections pipe centres = width - 100mm		

single vertical

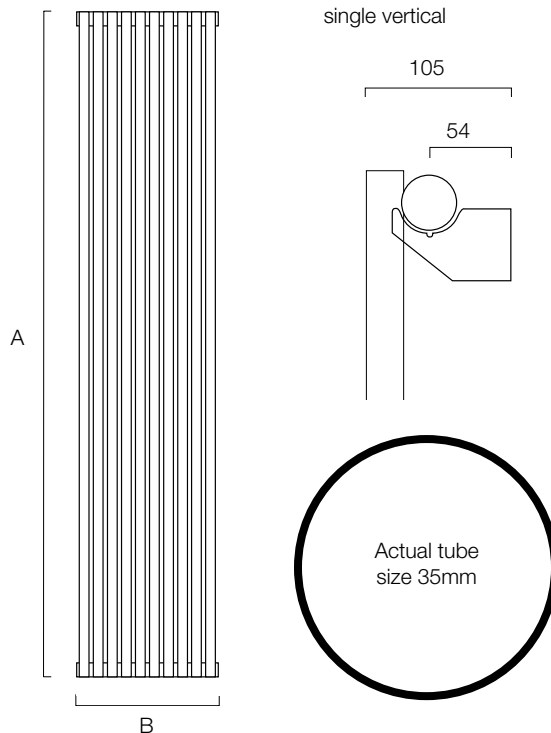



All stocked radiators have prices listed in purple and will be delivered in 3 - 5 working days.

Tornado Single Horizontal

Model	Height A (mm)	Width B (mm)	Watts At 50°C	Btu's At 50°C	White Ex VAT	Colours Ex VAT	White Inc VAT	Colours Inc VAT
TORNSH4597	456	971	486	1659	£351.00	£438.00	£421.20	£525.60
TORNSH6097	606	971	648	2218	£419.00	£523.00	£502.80	£627.60
TORNSH7597	756	971	810	2768	£516.00	£645.00	£619.20	£774.00
TORNSH4511	456	1166	588	2010	£379.00	£475.00	£454.80	£570.00
TORNSH6011	606	1166	784	2672	£458.00	£572.00	£549.60	£686.40
TORNSH7511	756	1166	980	3338	£545.00	£681.00	£654.00	£817.20
TORNSH4514	456	1471	738	2512	£458.00	£572.00	£549.60	£686.40
TORNSH6014	606	1471	984	3355	£530.00	£664.00	£636.00	£796.80
TORNSH7514	756	1471	1230	4188	£633.00	£792.00	£759.60	£950.40
TORNSH4517	456	1771	888	3038	£482.00	£603.00	£578.40	£723.60
TORNSH6017	606	1771	1184	4055	£574.00	£718.00	£688.80	£861.60
TORNSH7517	756	1771	1480	5068	£676.00	£846.00	£811.20	£1,015.20
TORNSH4519	456	1971	996	3386	£521.00	£651.00	£625.20	£781.20
TORNSH6019	606	1971	1328	4519	£525.00	£785.00	£630.00	£942.00
TORNSH7519	756	1971	1660	5645	£750.00	£938.00	£900.00	£1,125.60

Tornado Single Vertical

Model	Height A (mm)	Width B (mm)	Watts At 50°C	Btu's At 50°C	White Ex VAT	Colours Ex VAT	White Inc VAT	Colours Inc VAT
TORNSV9745	971	456	486	1659	£351.00	£438.00	£421.20	£525.60
TORNSV9760	971	606	648	2218	£419.00	£523.00	£502.80	£627.60
TORNSV9775	971	756	810	2768	£516.00	£645.00	£619.20	£774.00
TORNSV1145	1166	456	588	2010	£379.00	£475.00	£454.80	£570.00
TORNSV1160	1166	606	784	2672	£458.00	£572.00	£549.60	£686.40
TORNSV1175	1166	756	980	3338	£545.00	£681.00	£654.00	£817.20
TORNSV1445	1471	456	738	2512	£458.00	£572.00	£549.60	£686.40
TORNSV1460	1471	606	984	3355	£530.00	£664.00	£636.00	£796.80
TORNSV1475	1471	756	1230	4188	£633.00	£792.00	£759.60	£950.40
TORNSV1745	1771	456	888	3038	£482.00	£603.00	£578.40	£723.60
TORNSV1760	1771	606	1184	4055	£574.00	£718.00	£688.80	£861.60
TORNSV1775	1771	756	1480	5068	£676.00	£846.00	£811.20	£1,015.20
TORNSV1945	1971	456	996	3386	£521.00	£651.00	£625.20	£781.20
TORNSV1960	1971	606	1328	4519	£628.00	£785.00	£753.60	£942.00
TORNSV1975	1971	756	1660	5645	£750.00	£938.00	£900.00	£1,125.60

Tornado Double Horizontal

Model	Height A (mm)	Width B (mm)	Watts At 50°C	Btu's At 50°C	White Ex VAT	Colours Ex VAT	White Inc VAT	Colours Inc VAT
TORNDH4597	456	971	786	2683	£560.00	£700.00	£672.00	£840.00
TORNDH6097	606	971	1048	3580	£667.00	£834.00	£800.40	£1,000.80
TORNDH7597	756	971	1310	4471	£827.00	£1,035.00	£992.40	£1,242.00
TORNDH4511	456	1166	942	3218	£604.00	£755.00	£724.80	£906.00
TORNDH6011	606	1166	1256	4294	£735.00	£919.00	£882.00	£1,102.80
TORNDH7511	756	1166	1570	5375	£872.00	£1,090.00	£1,046.40	£1,308.00
TORNDH4514	456	1471	1182	4038	£731.00	£914.00	£877.20	£1,096.80
TORNDH6014	606	1471	1578	5389	£847.00	£1,059.00	£1,016.40	£1,270.80
TORNDH7514	756	1471	1970	6737	£1,013.00	£1,266.00	£1,215.60	£1,519.20
TORNDH4517	456	1771	1428	4887	£774.00	£968.00	£928.80	£1,161.60
TORNDH6017	606	1771	1904	6519	£916.00	£1,145.00	£1,099.20	£1,374.00
TORNDH7517	756	1771	2380	8150	£1,086.00	£1,358.00	£1,303.20	£1,629.60
TORNDH4519	456	1971	1590	5433	£813.00	£1,016.00	£975.60	£1,219.20
TORNDH6019	606	1971	2120	7236	£1,003.00	£1,254.00	£1,203.60	£1,504.80
TORNDH7519	756	1971	2650	9051	£1,198.00	£1,497.00	£1,437.60	£1,796.40

Tornado Double Vertical

Model	Height A (mm)	Width B (mm)	Watts At 50°C	Btu's At 50°C	White Ex VAT	Colours Ex VAT	White Inc VAT	Colours Inc VAT
TORNDV9745	971	456	786	2683	£560.00	£700.00	£672.00	£840.00
TORNDV9760	971	606	1048	3580	£667.00	£834.00	£800.40	£1,000.80
TORNDV9775	971	756	1310	4471	£827.00	£1,035.00	£992.40	£1,242.00
TORNDV1145	1166	456	942	3218	£604.00	£755.00	£724.80	£906.00
TORNDV1160	1166	606	1256	4294	£735.00	£919.00	£882.00	£1,102.80
TORNDV1175	1166	756	1570	5375	£872.00	£1,090.00	£1,046.40	£1,308.00
TORNDV1445	1471	456	1182	4038	£731.00	£914.00	£877.20	£1,096.80
TORNDV1460	1471	606	1578	5389	£847.00	£1,059.00	£1,016.40	£1,270.80
TORNDV1475	1471	756	1970	6737	£1,013.00	£1,266.00	£1,215.60	£1,519.20
TORNDV1745	1771	456	1428	4887	£774.00	£968.00	£928.80	£1,161.60
TORNDV1760	1771	606	1904	6519	£916.00	£1,145.00	£1,099.20	£1,374.00
TORNDV1775	1771	756	2380	8150	£1,086.00	£1,358.00	£1,303.20	£1,629.60
TORNDV1945	1971	456	1590	5433	£813.00	£1,016.00	£975.60	£1,219.20
TORNDV1960	1971	606	2120	7236	£1,003.00	£1,254.00	£1,203.60	£1,504.80
TORNDV1975	1971	756	2650	9051	£1,198.00	£1,497.00	£1,437.60	£1,796.40

Tornado	Pipe centres left to right	Pipe centres from wall	Depth from wall
Tornado single horizontal	width - 36mm	70mm - 75mm	103mm - 108mm
Tornado double horizontal	width - 36mm	80mm	110mm
Tornado single vertical	width + valves	56mm	87mm
Tornado double vertical	width + valves	56mm	87mm

Automatic bleed valve included with these radiators

Underneath Connections	Ex VAT	Inc VAT
B2CONN	£91.00	£109.20
Underneath Connections are made to order only, stock lines are BOE.		
Underneath Connections pipe centres = width - 82mm		

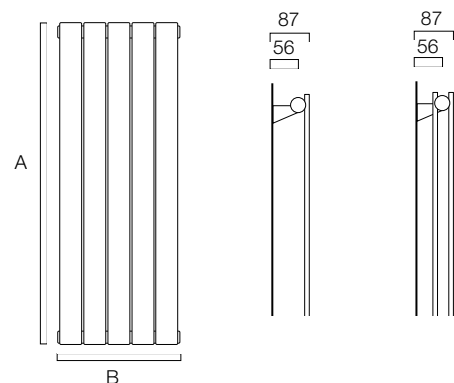
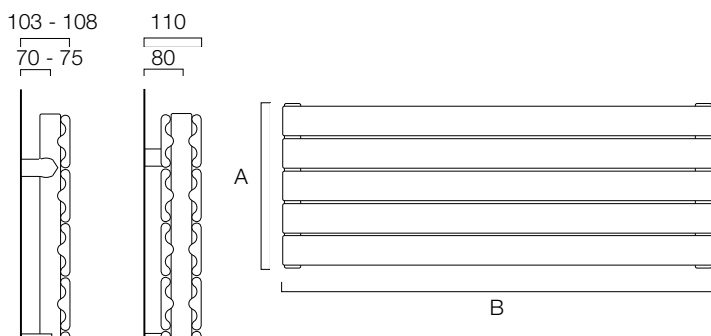

Camino Horizontal shown on pages 26 - 27



All stocked radiators have prices listed in purple and will be delivered in 3 - 5 working days.

Camino Single Horizontal

Model	Height A (mm)	Width B (mm)	Watts At 50°C	Btu's At 50°C	White Ex VAT	Colours Ex VAT	White Inc VAT	Colours Inc VAT
CAMISH3261	325	610	202	689	£258.00	£336.00	£309.60	£403.20
CAMISH4861	485	610	302	1031	£295.00	£384.00	£354.00	£460.80
CAMISH6461	645	610	403	1375	£388.00	£505.00	£465.60	£606.00
CAMISH8061	805	610	503	1717	£478.00	£621.00	£573.60	£745.20
CAMISH9661	965	610	604	2061	£564.00	£734.00	£676.80	£880.80
CAMISH3210	325	1010	326	1113	£318.00	£413.00	£381.60	£495.60
CAMISH4810	485	1010	490	1672	£383.00	£498.00	£459.60	£597.60
CAMISH6410	645	1010	654	2232	£469.00	£610.00	£562.80	£732.00
CAMISH8010	805	1010	817	2788	£580.00	£754.00	£696.00	£904.80
CAMISH9610	965	1010	981	3348	£686.00	£892.00	£823.20	£1,070.40
CAMISH3215	325	1510	482	1645	£377.00	£490.00	£452.40	£588.00
CAMISH4815	485	1510	724	2471	£474.00	£616.00	£568.80	£739.20
CAMISH6415	645	1510	965	3294	£567.00	£737.00	£680.40	£884.40
CAMISH8015	805	1510	1207	4119	£702.00	£913.00	£842.40	£1,095.60
CAMISH9615	965	1510	1449	4945	£827.00	£1,076.00	£992.40	£1,291.20
CAMISH3218	325	1810	573	1956	£399.00	£519.00	£478.80	£622.80
CAMISH4818	485	1810	859	2932	£503.00	£654.00	£603.60	£784.80
CAMISH6418	645	1810	1146	3911	£608.00	£791.00	£729.60	£949.20
CAMISH3220	325	2010	643	2195	£454.00	£590.00	£544.80	£708.00
CAMISH4820	485	2010	966	3297	£543.00	£706.00	£651.60	£847.20
CAMISH6420	645	2010	1290	4403	£671.00	£872.00	£805.20	£1,046.40

Camino Double Horizontal

Model	Height A (mm)	Width B (mm)	Watts At 50°C	Btu's At 50°C	White Ex VAT	Colours Ex VAT	White Inc VAT	Colours Inc VAT
CAMIDH3261	325	610	391	1334	£449.00	£584.00	£538.80	£700.80
CAMIDH4861	485	610	585	1997	£545.00	£709.00	£654.00	£850.80
CAMIDH6461	645	610	779	2659	£676.00	£879.00	£811.20	£1,054.80
CAMIDH8061	805	610	974	3324	£832.00	£1,081.00	£998.40	£1,297.20
CAMIDH9661	965	610	1168	3986	£982.00	£1,277.00	£1,178.40	£1,532.40
CAMIDH3210	325	1010	632	2157	£553.00	£719.00	£663.60	£862.80
CAMIDH4810	485	1010	949	3239	£667.00	£867.00	£800.40	£1,040.40
CAMIDH6410	645	1010	1265	4317	£817.00	£1,063.00	£980.40	£1,275.60
CAMIDH8010	805	1010	1582	5399	£1,010.00	£1,313.00	£1,212.00	£1,575.60
CAMIDH9610	965	1010	1899	6481	£1,194.00	£1,552.00	£1,432.80	£1,862.40
CAMIDH3215	325	1510	932	3181	£656.00	£853.00	£787.20	£1,023.60
CAMIDH4815	485	1510	1400	4778	£825.00	£1,072.00	£990.00	£1,286.40
CAMIDH6415	645	1510	1868	6375	£987.00	£1,283.00	£1,184.40	£1,539.60
CAMIDH8015	805	1510	2336	7973	£1,222.00	£1,589.00	£1,466.40	£1,906.80
CAMIDH9615	965	1510	2804	9570	£1,440.00	£1,872.00	£1,728.00	£2,246.40
CAMIDH3218	325	1810	1109	3785	£695.00	£903.00	£834.00	£1,083.60
CAMIDH4818	485	1810	1663	5676	£876.00	£1,139.00	£1,051.20	£1,366.80
CAMIDH6418	645	1810	2218	7570	£1,059.00	£1,377.00	£1,270.80	£1,652.40
CAMIDH3220	325	2010	1244	4246	£790.00	£1,027.00	£948.00	£1,232.40
CAMIDH4820	485	2010	1870	6382	£945.00	£1,229.00	£1,134.00	£1,474.80
CAMIDH6420	645	2010	2497	8522	£1,168.00	£1,518.00	£1,401.60	£1,821.60

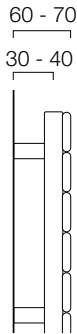

Camino horizontal	Pipe centres left to right	Pipe centres from wall	Depth from wall
Camino single horizontal	width - 50mm	30mm - 40mm	60mm - 70mm
Camino double horizontal	width - 50mm	77mm - 87mm	105mm - 115mm

Automatic bleed valve included with these radiators

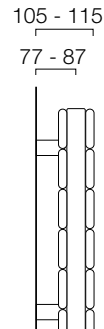

Optional side panels for double horizontal models

Model	Description	White Ex VAT	Colours Ex VAT	White Inc VAT	Colours Inc VAT
CAMIDHSP	Side Panel	£50.00	£68.00	£60.00	£81.60

Camino Triple Horizontal



shown on pages 26 - 27

Model	Height A (mm)	Width B (mm)	Watts At 50°C	Btu's At 50°C	White Ex VAT	Colours Ex VAT	White Inc VAT	Colours Inc VAT
CAMITH3610	363	1010	1130	3857	£1,134.00	£1,474.00	£1,360.80	£1,768.80
CAMITH4410	443	1010	1414	4826	£1,205.00	£1,566.00	£1,446.00	£1,879.20
CAMITH6410	643	1010	2122	7242	£1,583.00	£2,058.00	£1,899.60	£2,469.60
CAMITH3612	363	1210	1323	4515	£1,186.00	£1,541.00	£1,423.20	£1,849.20
CAMITH4412	443	1210	1652	5638	£1,256.00	£1,633.00	£1,507.20	£1,959.60
CAMITH6412	643	1210	2473	8440	£1,639.00	£2,131.00	£1,966.80	£2,557.20
CAMITH3615	363	1510	1668	5693	£1,345.00	£1,749.00	£1,614.00	£2,098.80
CAMITH4415	443	1510	2087	7123	£1,412.00	£1,836.00	£1,694.40	£2,203.20
CAMITH6415	643	1510	3133	10693	£1,901.00	£2,471.00	£2,281.20	£2,965.20
CAMITH3618	363	1810	1984	6771	£1,424.00	£1,851.00	£1,708.80	£2,221.20
CAMITH4418	443	1810	2479	8461	£1,496.00	£1,945.00	£1,795.20	£2,334.00
CAMITH6418	643	1810	3719	12693	£2,046.00	£2,660.00	£2,455.20	£3,192.00
CAMITH3620	363	2010	2225	7594	£1,619.00	£2,105.00	£1,942.80	£2,526.00
CAMITH4420	443	2010	2785	9505	£1,694.00	£2,203.00	£2,032.80	£2,643.60
CAMITH6420	643	2010	4186	14287	£2,247.00	£2,921.00	£2,696.40	£3,505.20

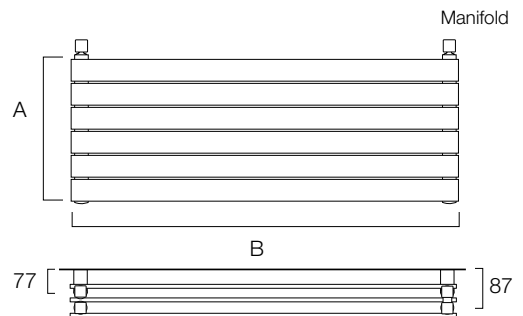

Please note height does not include manifold; add 40mm for overall height.

Camino triple	Pipe centres left to right	Pipe centre for flow	Pipe centres for return	Depth from wall
triple horizontal	width - 50mm	77mm	87mm	150mm

Please note: Manifold extends 40mm beyond radiator height

Automatic bleed valve included with these radiators

Optional side panels for triple horizontal models

Model	Description	White Ex VAT	Colours Ex VAT	White Inc VAT	Colours Inc VAT
CAMITHSP	Side Panel	£100.00	£136.00	£120.00	£163.20

Camino Vertical shown on pages 26 - 27



All stocked radiators have prices listed in purple and will be delivered in 3 - 5 working days.

Camino Single Vertical

Model	Height A (mm)	Width B (mm)	Watts Δt 50°C	Btu's Δt 50°C	White Ex VAT	Colours Ex VAT	White Inc VAT	Colours Inc VAT
CAMISV6132	610	325	246	840	£241.00	£314.00	£289.20	£376.80
CAMISV6148	610	485	368	1256	£293.00	£380.00	£351.60	£456.00
CAMISV6164	610	645	491	1676	£363.00	£472.00	£435.60	£566.40
CAMISV6180	610	805	614	2096	£446.00	£581.00	£535.20	£697.20
CAMISV6196	610	965	737	2515	£527.00	£686.00	£632.40	£823.20
CAMISV1032	1010	325	383	1307	£297.00	£386.00	£356.40	£463.20
CAMISV1048	1010	485	575	1962	£358.00	£465.00	£429.60	£558.00
CAMISV1064	1010	645	766	2614	£439.00	£571.00	£526.80	£685.20
CAMISV1080	1010	805	958	3270	£542.00	£705.00	£650.40	£846.00
CAMISV1096	1010	965	1150	3925	£641.00	£833.00	£769.20	£999.60
CAMISV1532	1510	325	552	1884	£352.00	£458.00	£422.40	£549.60
CAMISV1548	1510	485	828	2826	£443.00	£576.00	£531.60	£691.20
CAMISV1564	1510	645	1104	3768	£530.00	£689.00	£636.00	£826.80
CAMISV1580	1510	805	1380	4710	£656.00	£853.00	£787.20	£1,023.60
CAMISV1596	1510	965	1656	5652	£773.00	£1,005.00	£927.60	£1,206.00
CAMISV1832	1810	325	653	2229	£373.00	£485.00	£447.60	£582.00
CAMISV1848	1810	485	979	3341	£470.00	£611.00	£564.00	£733.20
CAMISV1864	1810	645	1306	4457	£569.00	£739.00	£682.80	£886.80
CAMISV2032	2010	325	721	2461	£424.00	£552.00	£508.80	£662.40
CAMISV2048	2010	485	1081	3689	£508.00	£660.00	£609.60	£792.00
CAMISV2064	2010	645	1442	4922	£627.00	£815.00	£752.40	£978.00

Camino Double Vertical

Model	Height A (mm)	Width B (mm)	Watts Δt 50°C	Btu's Δt 50°C	White Ex VAT	Colours Ex VAT	White Inc VAT	Colours Inc VAT
CAMIDV6132	610	325	370	1263	£420.00	£546.00	£504.00	£655.20
CAMIDV6148	610	485	556	1898	£509.00	£662.00	£610.80	£794.40
CAMIDV6164	610	645	741	2529	£632.00	£822.00	£758.40	£986.40
CAMIDV6180	610	805	926	3160	£777.00	£1,011.00	£932.40	£1,213.20
CAMIDV6196	610	965	1111	3792	£918.00	£1,194.00	£1,101.60	£1,432.80
CAMIDV1032	1010	325	572	1952	£516.00	£671.00	£619.20	£805.20
CAMIDV1048	1010	485	858	2928	£623.00	£810.00	£747.60	£972.00
CAMIDV1064	1010	645	1144	3904	£764.00	£993.00	£916.80	£1,191.60
CAMIDV1080	1010	805	1430	4881	£944.00	£1,227.00	£1,132.80	£1,472.40
CAMIDV1096	1010	965	1716	5857	£1,115.00	£1,450.00	£1,338.00	£1,740.00
CAMIDV1532	1510	325	813	2775	£613.00	£798.00	£735.60	£957.60
CAMIDV1548	1510	485	1219	4160	£771.00	£1,002.00	£925.20	£1,202.40
CAMIDV1564	1510	645	1626	5550	£922.00	£1,199.00	£1,106.40	£1,438.80
CAMIDV1580	1510	805	2032	6935	£1,142.00	£1,485.00	£1,370.40	£1,782.00
CAMIDV1596	1510	965	2438	8321	£1,346.00	£1,749.00	£1,615.20	£2,098.80
CAMIDV1832	1810	325	955	3259	£649.00	£844.00	£778.80	£1,012.80
CAMIDV1848	1810	485	1433	4891	£819.00	£1,064.00	£982.80	£1,276.80
CAMIDV1864	1810	645	1910	6519	£990.00	£1,287.00	£1,188.00	£1,544.40
CAMIDV2032	2010	325	1050	3584	£649.00	£844.00	£778.80	£1,012.80
CAMIDV2048	2010	485	1574	5372	£884.00	£1,149.00	£1,060.80	£1,378.80
CAMIDV2064	2010	645	2099	7164	£1,092.00	£1,419.00	£1,310.40	£1,702.80

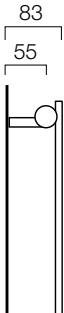

Camino	Pipe centres left to right	Pipe centres from wall	Depth from wall
Camino single vertical	width + valves	55mm	83mm
Camino double vertical	width + valves	55mm	83mm

Automatic bleed valve included with these radiators

Underneath Connections	Ex VAT	Inc VAT
B2CONN	£91.00	£109.20

Underneath Connections are made to order only, stock lines are BOE.
Underneath Connections pipe centres = width - 75mm

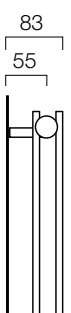

Optional side panels for double vertical models

Model	Description	White Ex VAT	Colours Ex VAT	White Inc VAT	Colours Inc VAT
CAMIDVSP	Side Panel	£95.00	£128.00	£114.00	£153.60

Camino Triple Vertical



shown on pages 26 - 27

Model	Height A (mm)	Width B (mm)	Watts Δt 50°C	Btu's Δt 50°C	White Ex VAT	Colours Ex VAT	White Inc VAT	Colours Inc VAT
CAMITV1036	1010	363	769	2625	£1,043.00	£1,355.00	£1,251.60	£1,626.00
CAMITV1044	1010	443	961	3280	£1,109.00	£1,442.00	£1,330.80	£1,730.40
CAMITV1064	1010	643	1443	4925	£1,462.00	£1,901.00	£1,754.40	£2,281.20
CAMITV1236	1210	363	900	3072	£1,088.00	£1,415.00	£1,305.60	£1,698.00
CAMITV1244	1210	443	1123	3833	£1,156.00	£1,503.00	£1,387.20	£1,803.60
CAMITV1264	1210	643	1682	5741	£1,515.00	£1,970.00	£1,818.00	£2,364.00
CAMITV1536	1510	363	1134	3870	£1,177.00	£1,530.00	£1,412.40	£1,836.00
CAMITV1544	1510	443	1419	4843	£1,242.00	£1,615.00	£1,490.40	£1,938.00
CAMITV1564	1510	643	2131	7273	£1,641.00	£2,134.00	£1,969.20	£2,560.80
CAMITV1836	1810	363	1349	4604	£1,299.00	£1,689.00	£1,558.80	£2,026.80
CAMITV1844	1810	443	1686	5754	£1,364.00	£1,773.00	£1,636.80	£2,127.60
CAMITV1864	1810	643	2529	8631	£1,848.00	£2,402.00	£2,217.60	£2,882.40
CAMITV2036	2010	363	1513	5164	£1,414.00	£1,839.00	£1,696.80	£2,206.80
CAMITV2044	2010	443	1894	6464	£1,483.00	£1,929.00	£1,779.60	£2,314.80
CAMITV2064	2010	643	2847	9717	£2,004.00	£2,606.00	£2,404.80	£3,127.20

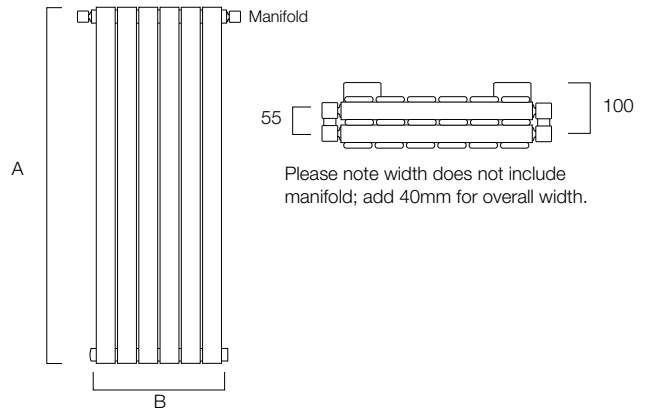

Camino triple	Pipe centres left to right	Pipe centre for flow	Pipe centres for return	Depth from wall
triple vertical	width + valves	55mm	87mm	128mm

Automatic bleed valve included with these radiators

Optional side panels for triple vertical models

Model	Description	White Ex VAT	Colours Ex VAT	White Inc VAT	Colours Inc VAT
CAMITVSP	Side Panel	£190.00	£256.00	£228.00	£307.20



Picchio Horizontal

shown on pages 28 - 29



All stocked radiators have prices listed in purple and will be delivered in 3 - 5 working days.

Picchio Single Horizontal

Model	Height A (mm)	Width B (mm)	Watts Δt 50°C	Btu's Δt 50°C	White Ex VAT	Colours Ex VAT	White Inc VAT	Colours Inc VAT
PICCSH3061	305	610	198	676	£223.00	£311.00	£267.60	£373.20
PICCSH4561	455	610	298	1017	£268.00	£373.00	£321.60	£447.60
PICCSH6061	605	610	397	1355	£333.00	£464.00	£399.60	£556.80
PICCSH7561	755	610	496	1692	£394.00	£549.00	£472.80	£658.80
PICCSH9061	905	610	595	2030	£473.00	£659.00	£567.60	£790.80
PICCSH3010	305	1010	319	1088	£259.00	£362.00	£310.80	£434.40
PICCSH4510	455	1010	479	1634	£317.00	£443.00	£380.40	£531.60
PICCSH6010	605	1010	639	2180	£381.00	£530.00	£457.20	£636.00
PICCSH7510	755	1010	798	2723	£470.00	£655.00	£564.00	£786.00
PICCSH9010	905	1010	958	3269	£564.00	£787.00	£676.80	£944.40
PICCSH1010	1055	1010	1118	3816	£699.00	£973.00	£838.80	£1,167.60
PICCSH3015	305	1510	469	1601	£317.00	£443.00	£380.40	£531.60
PICCSH4515	455	1510	703	2399	£415.00	£578.00	£498.00	£693.60
PICCSH6015	605	1510	937	3198	£484.00	£673.00	£580.80	£807.60
PICCSH7515	755	1510	1172	4000	£578.00	£805.00	£693.60	£966.00
PICCSH9015	905	1510	1406	4799	£694.00	£966.00	£832.80	£1,159.20
PICCSH3018	305	1810	555	1894	£333.00	£465.00	£399.60	£558.00
PICCSH4518	455	1810	833	2843	£441.00	£614.00	£529.20	£736.80
PICCSH6018	605	1810	1111	3792	£523.00	£728.00	£627.60	£873.60
PICCSH3020	305	2010	614	2096	£369.00	£514.00	£442.80	£616.80
PICCSH4520	455	2010	921	3143	£476.00	£663.00	£571.20	£795.60
PICCSH6020	605	2010	1228	4191	£573.00	£798.00	£687.60	£957.60

Picchio Double Horizontal

Model	Height A (mm)	Width B (mm)	Watts Δt 50°C	Btu's Δt 50°C	White Ex VAT	Colours Ex VAT	White Inc VAT	Colours Inc VAT
PICCDH3061	305	610	279	952	£357.00	£498.00	£428.40	£597.60
PICCDH4561	455	610	418	1427	£428.00	£597.00	£513.60	£716.40
PICCDH6061	605	610	557	1901	£533.00	£742.00	£639.60	£890.40
PICCDH7561	755	610	697	2379	£630.00	£877.00	£756.00	£1,052.40
PICCDH9061	905	610	836	2853	£756.00	£1,054.00	£907.20	£1,264.80
PICCDH3010	305	1010	500	1707	£417.00	£580.00	£500.40	£696.00
PICCDH4510	455	1010	751	2563	£507.00	£707.00	£608.40	£848.40
PICCDH6010	605	1010	1001	3416	£609.00	£848.00	£730.80	£1,017.60
PICCDH7510	755	1010	1251	4270	£751.00	£1,047.00	£901.20	£1,256.40
PICCDH9010	905	1010	1501	5123	£903.00	£1,258.00	£1,083.60	£1,509.60
PICCDH1010	1055	1010	1751	5976	£1,118.00	£1,557.00	£1,341.60	£1,868.40
PICCDH3015	305	1510	803	2741	£509.00	£709.00	£610.80	£850.80
PICCDH4515	455	1510	1205	4113	£664.00	£925.00	£796.80	£1,110.00
PICCDH6015	605	1510	1606	5481	£772.00	£1,076.00	£926.40	£1,291.20
PICCDH7515	755	1510	2008	6853	£924.00	£1,288.00	£1,108.80	£1,545.60
PICCDH9015	905	1510	2409	8222	£1,110.00	£1,545.00	£1,332.00	£1,854.00
PICCDH3018	305	1810	997	3403	£534.00	£744.00	£640.80	£892.80
PICCDH4518	455	1810	1495	5102	£706.00	£983.00	£847.20	£1,179.60
PICCDH6018	605	1810	1993	6802	£835.00	£1,163.00	£1,002.00	£1,395.60
PICCDH3020	305	2010	1130	3857	£582.00	£810.00	£698.40	£972.00
PICCDH4520	455	2010	1695	5785	£741.00	£1,033.00	£889.20	£1,239.60
PICCDH6020	605	2010	2260	7713	£916.00	£1,275.00	£1,099.20	£1,530.00

60 - 70
30 - 40

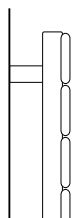

Picchio horizontal	Pipe centres left to right	Pipe centres from wall	Depth from wall
Picchio single horizontal	width - 50mm	30mm - 40mm	60mm - 70mm
Picchio double horizontal	width - 50mm	77mm - 87mm	105mm - 115mm

Automatic bleed valve included with these radiators

105 - 115
77 - 87

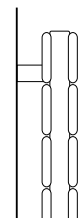

Optional side panels for double horizontal models

Model	Description	White Ex VAT	Colours Ex VAT	White Inc VAT	Colours Inc VAT
PICCDHSP	Side Panel	£50.00	£68.00	£60.00	£81.60

Picchio Triple

Picchio Triple Horizontal

Model	Height A (mm)	Width B (mm)	Watts Δt 50°C	Btu's Δt 50°C	White Ex VAT	Colours Ex VAT	White Inc VAT	Colours Inc VAT
PICCTH3410	343	1010	720	2457	£740.00	£925.00	£888.00	£1,110.00
PICCTH4910	493	1010	1080	3685	£905.00	£1,131.00	£1,086.00	£1,357.20
PICCTH6410	643	1010	1440	4913	£1,084.00	£1,355.00	£1,300.80	£1,626.00
PICCTH3412	343	1210	872	2975	£875.00	£1,094.00	£1,050.00	£1,312.80
PICCTH4912	493	1210	1308	4463	£1,061.00	£1,327.00	£1,273.20	£1,592.40
PICCTH6412	643	1210	1744	5951	£1,288.00	£1,610.00	£1,545.60	£1,932.00
PICCTH3415	343	1510	1094	3733	£980.00	£1,225.00	£1,176.00	£1,470.00
PICCTH4915	493	1510	1642	5603	£1,280.00	£1,600.00	£1,536.00	£1,920.00
PICCTH6415	643	1510	2189	7469	£1,491.00	£1,863.00	£1,789.20	£2,235.60
PICCTH3418	343	1810	1315	4487	£1,029.00	£1,286.00	£1,234.80	£1,543.20
PICCTH4918	493	1810	1973	6732	£1,361.00	£1,701.00	£1,633.20	£2,041.20
PICCTH6418	643	1810	2630	8974	£1,612.00	£2,015.00	£1,934.40	£2,418.00
PICCTH3420	343	2010	1461	4985	£1,213.00	£1,516.00	£1,455.60	£1,819.20
PICCTH4920	493	2010	2191	7476	£1,556.00	£1,945.00	£1,867.20	£2,334.00
PICCTH6420	643	2010	2921	9966	£1,902.00	£2,378.00	£2,282.40	£2,853.60

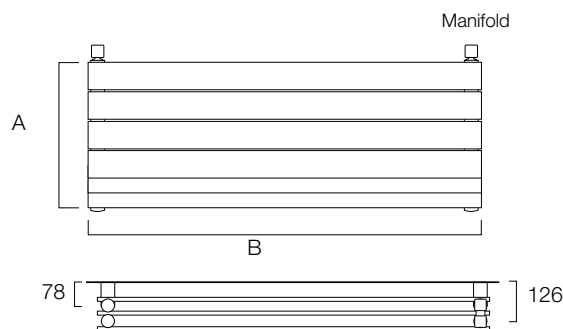

Please note height does not include manifold; add 40mm for overall height.

Picchio Triple	Pipe centres left to right	Pipe centre for flow	Pipe centres for return	Depth from wall
Triple horizontal	width - 50mm	78mm	126mm	151mm

Please note: Manifold extends 40mm beyond radiator width / height

Automatic bleed valve included with these radiators

Optional side panels for triple horizontal models

Model	Description	White Ex VAT	Colours Ex VAT	White Inc VAT	Colours Inc VAT
PICCTHSP	Side Panel	£100.00	£136.00	£120.00	£163.20

Picchio Vertical

shown on pages 28 - 29



All stocked radiators have prices listed in purple and will be delivered in 3 - 5 working days.

Picchio Single Vertical

Model	Height A (mm)	Width B (mm)	Watts Δt 50°C	Btu's Δt 50°C	White Ex VAT	Colours Ex VAT	White Inc VAT	Colours Inc VAT
PICCSV6130	610	305	207	706	£223.00	£311.00	£267.60	£373.20
PICCSV6145	610	455	311	1061	£268.00	£373.00	£321.60	£447.60
PICCSV6160	610	605	415	1416	£333.00	£464.00	£399.60	£556.80
PICCSV6175	610	755	519	1771	£394.00	£549.00	£472.80	£658.80
PICCSV6190	610	905	662	2122	£473.00	£659.00	£567.60	£790.80
PICCSV6115	610	1505	1037	3539	£836.00	£1,164.00	£1,003.20	£1,396.80
PICCSV1030	1010	305	333	1136	£259.00	£362.00	£310.80	£434.40
PICCSV1045	1010	455	499	1703	£317.00	£443.00	£380.40	£531.60
PICCSV1060	1010	605	665	2269	£381.00	£530.00	£457.20	£636.00
PICCSV1075	1010	755	832	2839	£470.00	£655.00	£564.00	£786.00
PICCSV1090	1010	905	998	3405	£564.00	£787.00	£676.80	£944.40
PICCSV1010	1010	1055	1164	3973	£699.00	£973.00	£838.80	£1,167.60
PICCSV1012	1010	1205	1331	4543	£799.00	£1,113.00	£958.80	£1,335.60
PICCSV1530	1510	305	491	1675	£317.00	£443.00	£380.40	£531.60
PICCSV1545	1510	455	736	2511	£415.00	£578.00	£498.00	£693.60
PICCSV1560	1510	605	981	3347	£484.00	£673.00	£580.80	£807.60
PICCSV1575	1510	755	1226	4183	£578.00	£805.00	£693.60	£966.00
PICCSV1590	1510	905	1472	5022	£694.00	£966.00	£832.80	£1,159.20
PICCSV1510	1510	1055	1717	5858	£809.00	£1,127.00	£970.80	£1,352.40
PICCSV1830	1810	305	587	2003	£333.00	£465.00	£399.60	£558.00
PICCSV1845	1810	455	881	3006	£441.00	£614.00	£529.20	£736.80
PICCSV1860	1810	605	1174	4006	£523.00	£728.00	£627.60	£873.60
PICCSV2030	2010	305	653	2228	£369.00	£514.00	£442.80	£616.80
PICCSV2045	2010	455	979	3340	£476.00	£663.00	£571.20	£795.60
PICCSV2060	2010	605	1305	4453	£573.00	£798.00	£687.60	£957.60

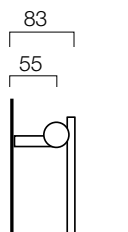

Picchio vertical	Pipe centres left to right	Pipe centres from wall	Depth from wall
Picchio single vertical	width + valves	55mm	83mm
Picchio double vertical	width + valves	55mm	83mm

Automatic bleed valve included with these radiators

Picchio Double Vertical

Model	Height A (mm)	Width B (mm)	Watts Δt 50°C	Btu's Δt 50°C	White Ex VAT	Colours Ex VAT	White Inc VAT	Colours Inc VAT
PICCDV6130	610	305	332	1133	£357.00	£498.00	£428.40	£597.60
PICCDV6145	610	455	498	1699	£428.00	£597.00	£513.60	£716.40
PICCDV6160	610	605	664	2266	£533.00	£742.00	£639.60	£890.40
PICCDV6175	610	755	830	2832	£630.00	£877.00	£756.00	£1,052.40
PICCDV6190	610	905	996	3398	£756.00	£1,054.00	£907.20	£1,264.80
PICCDV6115	610	1505	1660	5666	£1,337.00	£1,862.00	£1,604.40	£2,234.40
PICCDV1030	1010	305	506	1726	£417.00	£580.00	£500.40	£696.00
PICCDV1045	1010	455	758	2586	£507.00	£707.00	£608.40	£848.40
PICCDV1060	1010	605	1011	3450	£609.00	£848.00	£730.80	£1,017.60
PICCDV1075	1010	755	1264	4313	£751.00	£1,047.00	£901.20	£1,256.40
PICCDV1090	1010	905	1517	5176	£903.00	£1,258.00	£1,083.60	£1,509.60
PICCDV1010	1010	1055	1770	6041	£1,118.00	£1,557.00	£1,341.60	£1,868.40
PICCDV1012	1010	1205	2022	6901	£1,279.00	£1,782.00	£1,534.80	£2,138.40
PICCDV1530	1510	305	731	2494	£509.00	£709.00	£610.80	£850.80
PICCDV1545	1510	455	1096	3740	£664.00	£925.00	£796.80	£1,110.00
PICCDV1560	1510	605	1491	4985	£772.00	£1,076.00	£926.40	£1,291.20
PICCDV1575	1510	755	1827	6234	£924.00	£1,288.00	£1,108.80	£1,545.60
PICCDV1590	1510	905	2192	7479	£1,110.00	£1,502.00	£1,332.00	£1,802.40
PICCDV1510	1510	1055	2557	8724	£1,294.00	£1,802.00	£1,552.80	£2,162.40
PICCDV1830	1810	305	874	2982	£534.00	£744.00	£640.80	£892.80
PICCDV1845	1810	455	1311	4473	£706.00	£983.00	£847.20	£1,179.60
PICCDV1860	1810	605	1748	5964	£835.00	£1,163.00	£1,002.00	£1,395.60
PICCDV2030	2010	305	974	3323	£582.00	£810.00	£698.40	£972.00
PICCDV2045	2010	455	1461	4985	£741.00	£1,033.00	£889.20	£1,239.60
PICCDV2060	2010	605	1948	6647	£916.00	£1,275.00	£1,099.20	£1,530.00

Underneath Connections	Ex VAT	Inc VAT
B2CONN	£91.00	£109.20

Underneath Connections are made to order only, stock lines are BOE.
Underneath Connections pipe centres = width - 75mm

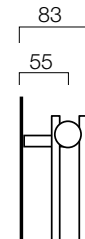

Optional side panels for double vertical models

Model	Description	White Ex VAT	Colours Ex VAT	White Inc VAT	Colours Inc VAT
PICCDVSP	Side Panel	£95.00	£128.00	£114.00	£153.60

Picchio Triple

shown on page 30



Picchio Triple Vertical

Model	Height A (mm)	Width B (mm)	Watts Δt 50°C	Btu's Δt 50°C	White Ex VAT	Colours Ex VAT	White Inc VAT	Colours Inc VAT
PICCTV1034	1010	343	736	2511	£740.00	£925.00	£888.00	£1,110.00
PICCTV1049	1010	493	1105	3770	£905.00	£1,131.00	£1,086.00	£1,357.20
PICCTV1064	1010	643	1473	5026	£1,084.00	£1,355.00	£1,300.80	£1,626.00
PICCTV1234	1210	343	863	2945	£875.00	£1,094.00	£1,050.00	£1,312.80
PICCTV1249	1210	493	1295	4419	£1,061.00	£1,327.00	£1,273.20	£1,592.40
PICCTV1264	1210	643	1726	5889	£1,288.00	£1,610.00	£1,545.60	£1,932.00
PICCTV1534	1510	343	1051	3586	£980.00	£1,225.00	£1,176.00	£1,470.00
PICCTV1549	1510	493	1576	5377	£1,280.00	£1,600.00	£1,536.00	£1,920.00
PICCTV1564	1510	643	2102	7172	£1,491.00	£1,863.00	£1,789.20	£2,235.60
PICCTV1834	1810	343	1238	4224	£1,029.00	£1,286.00	£1,234.80	£1,543.20
PICCTV1849	1810	493	1857	6336	£1,361.00	£1,701.00	£1,633.20	£2,041.20
PICCTV1864	1810	643	2477	8452	£1,612.00	£2,015.00	£1,934.40	£2,418.00
PICCTV2034	2010	343	1362	4647	£1,213.00	£1,516.00	£1,455.60	£1,819.20
PICCTV2049	2010	493	2044	6974	£1,556.00	£1,945.00	£1,867.20	£2,334.00
PICCTV2064	2010	643	2725	9298	£1,902.00	£2,378.00	£2,282.40	£2,853.60

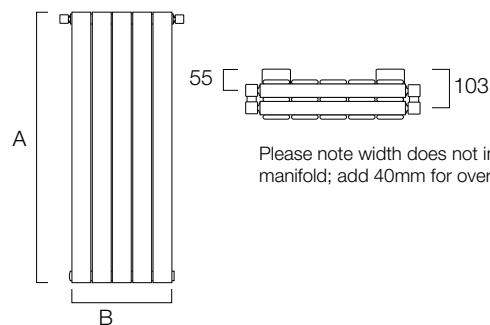

Please note width does not include manifold; add 40mm for overall width.

Picchio Triple	Pipe centres left to right	Pipe centre for flow	Pipe centres for return	Depth from wall
Triple vertical	width + valves	55mm	103mm	132mm

Please note: Manifold extends 40mm beyond radiator width / height
Automatic bleed valve included with these radiators

Optional side panels for triple vertical models

Model	Description	White Ex VAT	Colours Ex VAT	White Inc VAT	Colours Inc VAT
PICCTVSP	Side Panel	£190.00	£256.00	£228.00	£307.20



Picchio Chrome

shown on page 28 - 29



All stocked radiators have prices listed in purple and will be delivered in 3 - 5 working days.

Picchio Chrome Horizontal

Model	Height A (mm)	Width B (mm)	Watts Δt 50°C	Btu's Δt 50°C	Chrome Ex VAT	Chrome Inc VAT
PICCSH3010C	305	1010	250	853	£753.00	£903.60
PICCSH4510C	455	1010	374	1276	£921.00	£1,105.20
PICCSH6010C	605	1010	499	1703	£1,103.00	£1,323.60
PICCSH3015C	305	1510	368	1256	£921.00	£1,105.20
PICCSH4515C	455	1510	552	1884	£1,202.00	£1,442.40
PICCSH6015C	605	1510	736	2512	£1,400.00	£1,680.00
PICCSH3018C	305	1810	440	1502	£966.00	£1,159.20
PICCSH4518C	455	1810	661	2256	£1,278.00	£1,533.60
PICCSH6018C	605	1810	881	3007	£1,514.00	£1,816.80

Picchio Chrome horizontal	Pipe centres left to right	Pipe centres from wall	Depth from wall
Picchio Chrome horizontal	width - 50mm	32mm	60mm
Automatic bleed valve included with these radiators			

Please Note: For Picchio Chrome horizontal drawings please see page 126

Picchio Chrome Vertical

Model	Height A (mm)	Width B (mm)	Watts Δt 50°C	Btu's Δt 50°C	Chrome Ex VAT	Chrome Inc VAT
PICCSV1030C	1010	305	250	853	£753.00	£903.60
PICCSV1045C	1010	455	374	1276	£921.00	£1,105.20
PICCSV1530C	1510	305	368	1256	£921.00	£1,105.20
PICCSV1545C	1510	455	552	1883	£1,202.00	£1,442.40
PICCSV1830C	1810	305	440	1501	£966.00	£1,159.20
PICCSV1845C	1810	455	661	2255	£1,278.00	£1,533.60
PICCSV1860C	1810	605	881	3006	£1,514.00	£1,816.80
PICCSV2030C	2010	305	486	1658	£1,069.00	£1,282.80
PICCSV2045C	2010	455	731	2494	£1,381.00	£1,657.20

Picchio Chrome vertical	Pipe centres left to right	Pipe centres from wall	Depth from wall
Picchio Chrome vertical	width + valves	53mm	84mm
Automatic bleed valve included with these radiators			

Please Note: For Picchio Chrome vertical drawings please see page 127

Stanza

shown on page 31



Stanza Vertical

Model	Height A (mm)	Width B (mm)	Watts Δt 50°C	Btu's Δt 50°C	White Ex VAT	Colours Ex VAT	White Inc VAT	Colours Inc VAT
STANV9038	900	380	594	2027	£369.00	£480.00	£442.80	£576.00
STANV9048	900	480	743	2536	£418.00	£542.00	£501.60	£650.40
STANV9058	900	580	892	3044	£461.00	£585.00	£553.20	£702.00
STANV9068	900	680	1023	3491	£508.00	£659.00	£609.60	£790.80
STANV1338	1300	380	838	2860	£418.00	£542.00	£501.60	£650.40
STANV1348	1300	480	1047	3573	£475.00	£618.00	£570.00	£741.60
STANV1358	1300	580	1235	4215	£530.00	£690.00	£636.00	£828.00
STANV1368	1300	680	1441	4918	£585.00	£761.00	£702.00	£913.20
STANV1738	1700	380	1033	3526	£464.00	£605.00	£556.80	£726.00
STANV1748	1700	480	1267	4324	£534.00	£694.00	£640.80	£832.80
STANV1758	1700	580	1521	5191	£588.00	£760.00	£705.60	£912.00
STANV1768	1700	680	1741	5942	£662.00	£861.00	£794.40	£1,033.20

Stanza Horizontal

Model	Height A (mm)	Width B (mm)	Watts Δt 50°C	Btu's Δt 50°C	White Ex VAT	Colours Ex VAT	White Inc VAT	Colours Inc VAT
STANH5648	560	480	469	1601	£375.00	£487.00	£450.00	£584.40
STANH5668	560	680	646	2205	£459.00	£597.00	£550.80	£716.40
STANH5688	560	880	816	2785	£541.00	£705.00	£649.20	£846.00
STANH5610	560	1080	998	3406	£622.00	£809.00	£746.40	£970.80
STANH5612	560	1280	1158	3952	£675.00	£878.00	£810.00	£1,053.60
STANH6148	610	480	509	1737	£394.00	£511.00	£472.80	£613.20
STANH6168	610	680	701	2393	£495.00	£642.00	£594.00	£770.40
STANH6188	610	880	886	3024	£597.00	£774.00	£716.40	£928.80
STANH6110	610	1080	1083	3696	£696.00	£902.00	£835.20	£1,082.40
STANH6112	610	1280	1275	4352	£767.00	£994.00	£920.40	£1,192.80

Stanza	Pipe centres left to right	Pipe centres from wall	Depth from wall
Stanza	width + valves	62mm - 70mm	84mm - 92mm

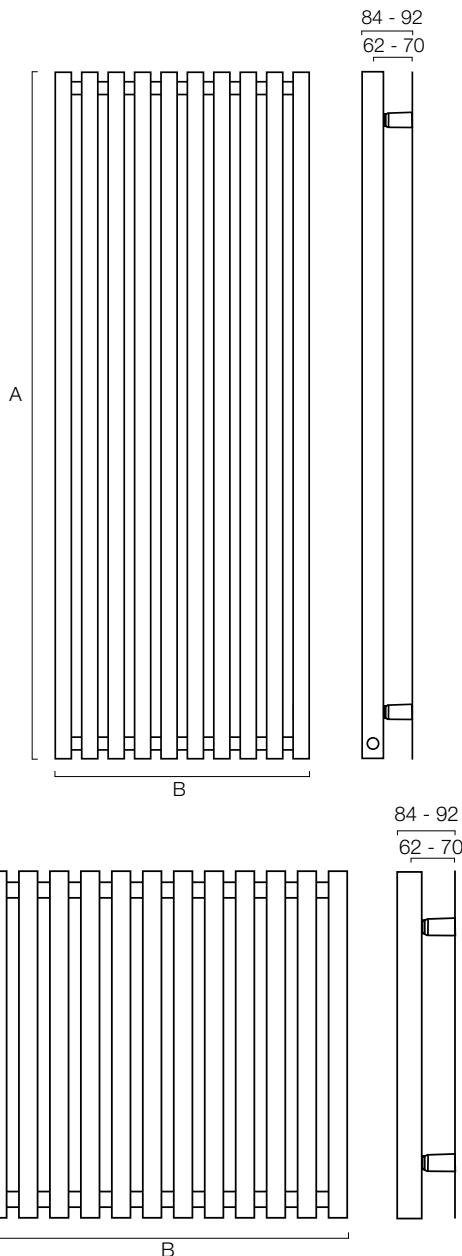



All stocked radiators have prices listed in purple and will be delivered in 3 - 5 working days.

Trim Single Horizontal

Model	Height A (mm)	Width B (mm)	Watts Δt 50°C	Btu's Δt 50°C	White Ex VAT	Colours Ex VAT	White Inc VAT	Colours Inc VAT
TRIMSH3460	344	600	312	1065	£464.00	£580.00	£556.80	£696.00
TRIMSH4460	440	600	401	1369	£505.00	£631.00	£606.00	£757.20
TRIMSH3412	344	1200	623	2126	£508.00	£635.00	£609.60	£762.00
TRIMSH4812	488	1200	890	3038	£565.00	£706.00	£678.00	£847.20
TRIMSH5812	584	1200	1068	3645	£631.00	£789.00	£757.20	£946.80
TRIMSH3416	344	1600	831	2836	£569.00	£711.00	£682.80	£853.20
TRIMSH4816	488	1600	1187	4051	£646.00	£808.00	£775.20	£969.60
TRIMSH5816	584	1600	1425	4864	£712.00	£890.00	£854.40	£1,068.00
TRIMSH3418	344	1800	935	3191	£582.00	£727.00	£698.40	£872.40
TRIMSH3918	392	1800	1068	3645	£610.00	£763.00	£732.00	£915.60
TRIMSH4818	488	1800	1336	4560	£667.00	£834.00	£800.40	£1,000.80
TRIMSH5818	584	1800	1603	5471	£738.00	£922.00	£885.60	£1,106.40
TRIMSH3420	344	2000	1039	3546	£596.00	£745.00	£715.20	£894.00
TRIMSH3920	392	2000	1187	4051	£628.00	£786.00	£753.60	£943.20
TRIMSH4820	488	2000	1484	5065	£687.00	£859.00	£824.40	£1,030.80
TRIMSH5820	584	2000	1781	6079	£760.00	£951.00	£912.00	£1,141.20

Trim Double Horizontal

Model	Height A (mm)	Width B (mm)	Watts Δt 50°C	Btu's Δt 50°C	White Ex VAT	Colours Ex VAT	White Inc VAT	Colours Inc VAT
TRIMDH3460	344	600	528	1802	£643.00	£803.00	£771.60	£963.60
TRIMDH4460	440	600	668	2280	£722.00	£903.00	£866.40	£1,083.60
TRIMDH3412	344	1200	1056	3604	£736.00	£920.00	£883.20	£1,104.00
TRIMDH4812	488	1200	1484	5065	£907.00	£1,134.00	£1,088.40	£1,360.80
TRIMDH5812	584	1200	1752	5980	£1,011.00	£1,264.00	£1,213.20	£1,516.80
TRIMDH3416	344	1600	1409	4809	£869.00	£1,086.00	£1,042.80	£1,303.20
TRIMDH4816	488	1600	1979	6754	£1,094.00	£1,368.00	£1,312.80	£1,641.60
TRIMDH5816	584	1600	2335	7969	£1,235.00	£1,544.00	£1,482.00	£1,852.80
TRIMDH3418	344	1800	1585	5410	£901.00	£1,126.00	£1,081.20	£1,351.20
TRIMDH3918	392	1800	1811	6181	£960.00	£1,200.00	£1,152.00	£1,440.00
TRIMDH4818	488	1800	2226	7597	£1,138.00	£1,422.00	£1,365.60	£1,706.40
TRIMDH5818	584	1800	2627	8966	£1,288.00	£1,610.00	£1,545.60	£1,932.00
TRIMDH3420	344	2000	1761	6010	£931.00	£1,164.00	£1,117.20	£1,396.80
TRIMDH3920	392	2000	2012	6867	£994.00	£1,243.00	£1,192.80	£1,491.60
TRIMDH4820	488	2000	2473	8440	£1,184.00	£1,480.00	£1,420.80	£1,776.00
TRIMDH5820	584	2000	2919	9963	£1,342.00	£1,677.00	£1,610.40	£2,012.40

Trim Single Vertical

Model	Height A (mm)	Width B (mm)	Watts Δt 50°C	Btu's Δt 50°C	White Ex VAT	Colours Ex VAT	White Inc VAT	Colours Inc VAT
TRIMSV6034	600	344	309	1055	£430.00	£538.00	£516.00	£645.60
TRIMSV6044	600	440	397	1355	£468.00	£585.00	£561.60	£702.00
TRIMSV1234	1200	344	584	1993	£470.00	£588.00	£564.00	£705.60
TRIMSV1248	1200	488	834	2846	£549.00	£686.00	£658.80	£823.20
TRIMSV1258	1200	584	1001	3416	£613.00	£767.00	£735.60	£920.40
TRIMSV1634	1600	344	760	2594	£527.00	£659.00	£632.40	£790.80
TRIMSV1648	1600	488	1085	3703	£628.00	£786.00	£753.60	£943.20
TRIMSV1658	1600	584	1302	4444	£692.00	£865.00	£830.40	£1,038.00
TRIMSV1834	1800	344	845	2884	£539.00	£674.00	£646.80	£808.80
TRIMSV1839	1800	392	966	3297	£566.00	£708.00	£679.20	£849.60
TRIMSV1848	1800	488	1207	4119	£649.00	£811.00	£778.80	£973.20
TRIMSV1858	1800	584	1448	4942	£716.00	£895.00	£859.20	£1,074.00
TRIMSV2034	2000	344	930	3174	£553.00	£691.00	£663.60	£829.20
TRIMSV2039	2000	392	1063	3628	£582.00	£728.00	£698.40	£873.60
TRIMSV2048	2000	488	1329	4536	£667.00	£834.00	£800.40	£1,000.80
TRIMSV2058	2000	584	1594	5440	£739.00	£924.00	£886.80	£1,108.80

Trim Double Vertical

Model	Height A (mm)	Width B (mm)	Watts Δt 50°C	Btu's Δt 50°C	White Ex VAT	Colours Ex VAT	White Inc VAT	Colours Inc VAT
TRIMDV6034	600	344	467	1594	£596.00	£745.00	£715.20	£894.00
TRIMDV6044	600	440	600	2048	£670.00	£838.00	£804.00	£1,005.60
TRIMDV1234	1200	344	877	2993	£682.00	£853.00	£818.40	£1,023.60
TRIMDV1248	1200	488	1253	4276	£840.00	£1,050.00	£1,008.00	£1,260.00
TRIMDV1258	1200	584	1503	5130	£937.00	£1,172.00	£1,124.40	£1,406.40
TRIMDV1634	1600	344	1139	3887	£805.00	£1,006.00	£966.00	£1,207.20
TRIMDV1648	1600	488	1628	5556	£1,014.00	£1,268.00	£1,216.80	£1,521.60
TRIMDV1658	1600	584	1953	6666	£1,145.00	£1,432.00	£1,374.00	£1,718.40
TRIMDV1834	1800	344	1266	4321	£835.00	£1,044.00	£1,002.00	£1,252.80
TRIMDV1839	1800	392	1447	4939	£890.00	£1,113.00	£1,068.00	£1,335.60
TRIMDV1848	1800	488	1809	6174	£1,055.00	£1,319.00	£1,266.00	£1,582.80
TRIMDV1858	1800	584	2171	7410	£1,194.00	£1,492.00	£1,432.80	£1,790.40
TRIMDV2034	2000	344	1392	4751	£863.00	£1,079.00	£1,035.60	£1,294.80
TRIMDV2039	2000	392	1591	5430	£921.00	£1,152.00	£1,105.20	£1,382.40
TRIMDV2048	2000	488	1989	6788	£1,098.00	£1,373.00	£1,317.60	£1,647.60
TRIMDV2058	2000	584	2386	8143	£1,244.00	£1,555.00	£1,492.80	£1,866.00

Trim	Pipe centres left to right	Pipe centres from wall	Depth from wall
single/double horizontal	width - 40mm	54mm	91mm
single/double vertical	width + valves	54mm	91mm

Automatic bleed valve included with these radiators

Underneath Connections	Ex VAT	Inc VAT
B2CONN	£91.00	£109.20

Underneath Connections must be specified at time of order

Underneath Connections pipe centres = width - 58mm

single horizontal

double horizontal

single vertical

double vertical

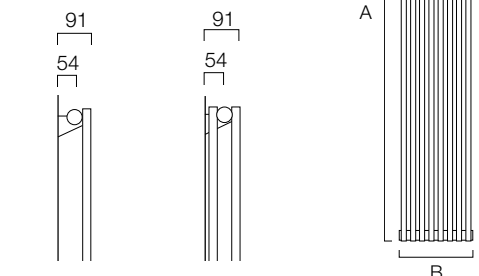
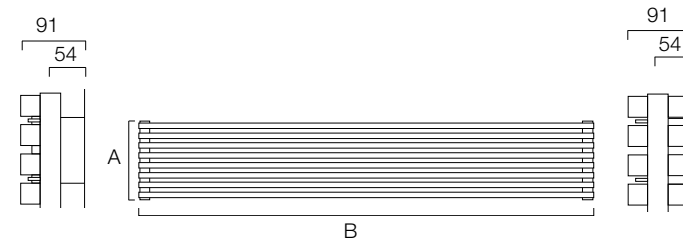

Volcano Cubed shown on pages 34 - 35



All stocked radiators have prices listed in purple and will be delivered in 3 - 5 working days.

Volcano Cubed Single Horizontal

Model	Height A (mm)	Width B (mm)	Watts Δt 50°C	Btu's Δt 50°C	White Ex VAT	Colours Ex VAT	White Inc VAT	Colours Inc VAT
CUBESH4072	400	721	604	2061	£382.00	£478.00	£458.40	£573.60
CUBESH5272	520	721	794	2710	£422.00	£527.00	£506.40	£632.40
CUBESH6072	600	721	905	3089	£462.00	£578.00	£554.40	£693.60
CUBESH4097	400	971	785	2679	£452.00	£564.00	£542.40	£676.80
CUBESH5297	520	971	1023	3491	£495.00	£618.00	£594.00	£741.60
CUBESH6097	600	971	1188	4055	£549.00	£687.00	£658.80	£824.40
CUBESH4014	400	1471	1151	3928	£520.00	£650.00	£624.00	£780.00
CUBESH5214	520	1471	1505	5137	£641.00	£800.00	£769.20	£960.00
CUBESH6014	600	1471	1725	5887	£746.00	£932.00	£895.20	£1,118.40
CUBESH4017	400	1771	1365	4659	£539.00	£673.00	£646.80	£807.60
CUBESH5217	520	1771	1839	6277	£684.00	£855.00	£820.80	£1,026.00
CUBESH6017	600	1771	2180	7440	£815.00	£1,020.00	£978.00	£1,224.00
CUBESH4019	400	1971	1511	5157	£593.00	£741.00	£711.60	£889.20
CUBESH5219	520	1971	2062	7038	£706.00	£882.00	£847.20	£1,058.40
CUBESH6019	600	1971	2373	8099	£800.00	£1,001.00	£960.00	£1,201.20

Volcano Cubed Single Vertical

Model	Height A (mm)	Width B (mm)	Watts Δt 50°C	Btu's Δt 50°C	White Ex VAT	Colours Ex VAT	White Inc VAT	Colours Inc VAT
CUBESV7240	721	400	604	2061	£382.00	£478.00	£458.40	£573.60
CUBESV7252	721	520	794	2710	£422.00	£527.00	£506.40	£632.40
CUBESV7260	721	600	905	3089	£462.00	£578.00	£554.40	£693.60
CUBESV9740	971	400	785	2679	£452.00	£564.00	£542.40	£676.80
CUBESV9752	971	520	1023	3491	£495.00	£618.00	£594.00	£741.60
CUBESV9760	971	600	1188	4055	£549.00	£687.00	£658.80	£824.40
CUBESV1440	1471	400	1151	3928	£520.00	£650.00	£624.00	£780.00
CUBESV1452	1471	520	1505	5137	£641.00	£800.00	£769.20	£960.00
CUBESV1460	1471	600	1725	5887	£746.00	£932.00	£895.20	£1,118.40
CUBESV1740	1771	400	1365	4659	£539.00	£673.00	£646.80	£807.60
CUBESV1752	1771	520	1839	6277	£684.00	£855.00	£820.80	£1,026.00
CUBESV1760	1771	600	2180	7440	£815.00	£1,020.00	£978.00	£1,224.00
CUBESV1940	1971	400	1511	5157	£593.00	£741.00	£711.60	£889.20
CUBESV1952	1971	520	2062	7038	£706.00	£882.00	£847.20	£1,058.40
CUBESV1960	1971	600	2373	8099	£800.00	£1,001.00	£960.00	£1,201.20

Volcano Cubed Double Horizontal

Model	Height A (mm)	Width B (mm)	Watts Δt 50°C	Btu's Δt 50°C	White Ex VAT	Colours Ex VAT	White Inc VAT	Colours Inc VAT
CUBEDH4072	400	721	1006	3433	£462.00	£578.00	£554.40	£693.60
CUBEDH5272	520	721	1324	4519	£527.00	£659.00	£632.40	£790.80
CUBEDH6072	600	721	1508	5147	£604.00	£755.00	£724.80	£906.00
CUBEDH4097	400	971	1308	4464	£618.00	£773.00	£741.60	£927.60
CUBEDH5297	520	971	1707	5826	£706.00	£882.00	£847.20	£1,058.40
CUBEDH6097	600	971	1982	6765	£804.00	£1,006.00	£964.80	£1,207.20
CUBEDH4014	400	1471	1919	6550	£688.00	£860.00	£825.60	£1,032.00
CUBEDH5214	520	1471	2509	8563	£884.00	£1,106.00	£1,060.80	£1,327.20
CUBEDH6014	600	1471	2876	9816	£1,059.00	£1,324.00	£1,270.80	£1,588.80
CUBEDH4017	400	1771	2275	7765	£757.00	£946.00	£908.40	£1,135.20
CUBEDH5217	520	1771	3068	10471	£1,005.00	£1,256.00	£1,206.00	£1,507.20
CUBEDH6017	600	1771	3634	12403	£1,183.00	£1,478.00	£1,419.60	£1,773.60
CUBEDH4019	400	1971	2518	8594	£855.00	£1,069.00	£1,026.00	£1,282.80
CUBEDH5219	520	1971	3438	11734	£1,030.00	£1,287.00	£1,236.00	£1,544.40
CUBEDH6019	600	1971	3955	13498	£1,179.00	£1,474.00	£1,414.80	£1,768.80

Volcano Cubed Double Vertical

Model	Height A (mm)	Width B (mm)	Watts Δt 50°C	Btu's Δt 50°C	White Ex VAT	Colours Ex VAT	White Inc VAT	Colours Inc VAT
CUBEDV7240	721	400	1006	3433	£462.00	£578.00	£554.40	£693.60
CUBEDV7252	721	520	1324	4519	£527.00	£659.00	£632.40	£790.80
CUBEDV7260	721	600	1508	5147	£604.00	£755.00	£724.80	£906.00
CUBEDV9740	971	400	1308	4464	£618.00	£773.00	£741.60	£927.60
CUBEDV9752	971	520	1707	5826	£706.00	£882.00	£847.20	£1,058.40
CUBEDV9760	971	600	1982	6765	£804.00	£1,006.00	£964.80	£1,207.20
CUBEDV1440	1471	400	1919	6550	£688.00	£860.00	£825.60	£1,032.00
CUBEDV1452	1471	520	2509	8563	£884.00	£1,106.00	£1,060.80	£1,327.20
CUBEDV1460	1471	600	2876	9816	£1,059.00	£1,324.00	£1,270.80	£1,588.80
CUBEDV1740	1771	400	2275	7765	£757.00	£946.00	£908.40	£1,135.20
CUBEDV1752	1771	520	3068	10471	£1,005.00	£1,256.00	£1,206.00	£1,507.20
CUBEDV1760	1771	600	3634	12403	£1,183.00	£1,478.00	£1,419.60	£1,773.60
CUBEDV1940	1971	400	2518	8594	£855.00	£1,069.00	£1,026.00	£1,282.80
CUBEDV1952	1971	520	3438	11734	£1,030.00	£1,287.00	£1,236.00	£1,544.40
CUBEDV1960	1971	600	3955	13498	£1,179.00	£1,474.00	£1,414.80	£1,768.80

Volcano Cubed horizontal	Pipe centres left to right	Pipe centres from wall	Depth from wall
Volcano Cubed single	width - 36mm	70mm - 75mm	112mm - 117mm
Volcano Cubed double	width - 36mm	56mm	102mm

Automatic bleed valve included with these radiators

Volcano Cubed vertical	Pipe centres left to right	Pipe centres from wall	Depth from wall
Volcano Cubed single	width + valves	56mm	95mm
Volcano Cubed double	width + valves	56mm	95mm

Automatic bleed valve included with these radiators

Underneath Connections	Ex VAT	Inc VAT
B2CONN	£91.00	£109.20
Underneath Connections are made to order only, stock lines are BOE.		
Underneath Connections pipe centres = width - 84mm		

single horizontal

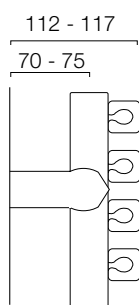

double horizontal

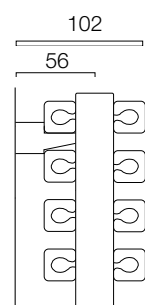

single vertical

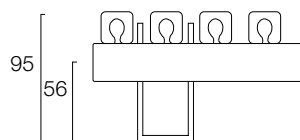

double vertical

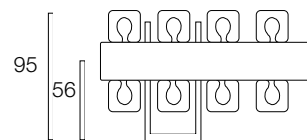

Aluminium shown on pages 36 - 45



All stocked radiators have prices listed in purple and will be delivered in 3 - 5 working days.

The Aluminium range is incredibly versatile with hundreds of possible size options across the range. When selecting the best configuration for your room you can alter the height and number of sections to achieve required BTU output within a fixed space.

- All prices and outputs for Vip and Oscar Royale are given per set size; all others are given by section.
- Royale prices include; plugs bushes, airvent, wall brackets and side panels
- Price per section includes plugs, bushes, air vent and wall brackets

These simple steps will help you choose a product that matches your requirements.

1. Calculate output & number of radiators per room
To find the output you require for each radiator identify the heat output for each room, for a detailed explanation on output see page 160 or visit our website at www.theradiatorcompany.co.uk. You should always check your requirements with your installer.

2. Choose your preferred model option

The Radiator Company Aluminium range is available in set sizes from the Royal ranges or a choice of 8 sectional models.

3. Choose a Height

Decide on a section height that matches the space available, allowing an additional 100mm to 150mm minimum clearance from the floor for pipe work & air flow. Height options in the sectional models vary; Heights up to 890mm select from; Vip, Mix, Vox, Ekos 95, Ekos 130 & Klass. Heights from 946 - 2070 select from; Oscar & Ekos Extra.

4. Calculate the number of sections you require

Listed next to each section, under 'BTUs', will be the output each section gives. Divide your required output by this number to find the total number of sections needed to match the output; e.g. if you have chosen a Mix 590mm high then 6048 BTUs divided by the section output of 420 BTUs = 15 sections.

5. Check the width

Check the number of sections you need will fit into the available space. Our Aluminium sections come in two widths; Vip, Vox, Mix Oscar, Klass = 80mm Ekos 95, Ekos 130 and Ekos Extra = 50mm e.g; 15 section Mix radiator 590 high will equal 15 x 80mm = 1200mm wide, plus 28mm for bushes, plus valves. If this is too wide then, if possible,

increase the height of each section
e.g: Mix 790mm high = 6048 BTUs divided by 549 BTUs per section = 11 sections = 880mm wide; plus bushes, plus valves.

The maximum number of sections that we can deliver in one piece is 20 (10 for Oscar & Ekos Extra). Larger radiators will have to be joined on site by your installer which will require the appropriate tools, available from us with a refundable deposit.

6. Choose any accessories required

You can choose from a selection of accessories to enhance your radiator

- End panels for Vip and Oscar
- Hanging Pegs
- Towel bars
- Multi brush to keep the section free from dust; maximising air flow.

7. Place your order

Place your order quoting the product code of your selected section plus the number of sections required.

Vip & Oscar Royale shown on pages 37 - 39



Available in set sizes only.

Vip Royale

Model	Sections	Height A (mm)	Width B (mm)	Watts Δt 50°C	Btu's Δt 50°C	Price Ex VAT	Price Inc VAT
VIPROY5940	5	590	400	625	2133	£257.00	£308.40
VIPROY5964	8	590	640	1000	3413	£349.00	£418.80
VIPROY5980	10	590	800	1250	4266	£410.00	£492.00
VIPROY5912	16	590	1280	2000	6826	£591.00	£709.20
VIPROY6940	5	690	400	710	2423	£264.00	£316.80
VIPROY6964	8	690	640	1136	3877	£358.00	£429.60
VIPROY6980	10	690	800	1420	4846	£421.00	£505.20
VIPROY6912	16	690	1280	2272	7754	£610.00	£732.00

Oscar Royale

Model	Sections	Height A (mm)	Width B (mm)	Watts Δt 50°C	Btu's Δt 50°C	Price Ex VAT	Price Inc VAT
OSCAROY1624	3	1646	240	816	2785	£448.00	£537.60
OSCAROY1632	4	1646	320	1088	3713	£536.00	£643.20
OSCAROY1648	6	1646	480	1632	5570	£710.00	£852.00
OSCAROY1664	8	1646	640	2176	7427	£885.00	£1,062.00
OSCAROY1824	3	1846	240	891	3041	£466.00	£559.20
OSCAROY1832	4	1846	320	1188	4055	£560.00	£672.00
OSCAROY1848	6	1846	480	1782	6082	£746.00	£895.20
OSCAROY1864	8	1846	640	2376	8109	£932.00	£1,118.40

Please specify colour option at time of order; Textured Light Grey, Black Gold, Polished Silver & Textured Matt Black. Note: Vip & Oscar Royale radiators are supplied with manual airvents only.

Vip shown on page 40



Model	Height A (mm)	Width B (mm)	Watts Δt 50°C	Btu's Δt 50°C	Price Ex VAT	Price Inc VAT
VIP44	440	80	94	321	£23.93	£28.72
VIP59	590	80	123	420	£24.37	£29.24
VIP69	690	80	142	485	£25.24	£30.29
VIP79	790	80	161	549	£28.72	£34.46
VIP89	890	80	180	614	£37.76	£45.31

Price and output are given per section



Oscar shown on page 41



Model	Height A (mm)	Width B (mm)	Watts Δt 50°C	Btu's Δt 50°C	White Ex VAT	White Inc VAT
OSCA94	946	80	175	597	£36.18	£43.42
OSCA10	1046	80	190	648	£40.74	£48.89
OSCA12	1246	80	218	744	£53.06	£63.67
OSCA14	1446	80	245	836	£65.54	£78.65
OSCA16	1646	80	271	925	£72.32	£86.78
OSCA18	1846	80	297	1014	£79.37	£95.24
OSCA20	2046	80	321	1096	£89.19	£107.03

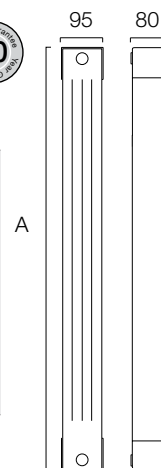

Vip End Panels (price is per pair)

Model	Height A (mm)	White Ex VAT	White Inc VAT
VIPEP44	440	£38.00	£45.60
VIPEP59	590	£42.00	£50.40
VIPEP69	690	£45.00	£54.00
VIPEP79	790	£47.00	£56.40
VIPEP89	890	£50.00	£60.00

Oscar End Panels (price is per pair)

Model	Height A (mm)	White Ex VAT	White Inc VAT
OSCAEP10	1020	£61.00	£73.20
OSCAEP12	1220	£64.00	£76.80
OSCAEP14	1420	£68.00	£81.60
OSCAEP16	1620	£79.00	£94.80
OSCAEP18	1820	£82.00	£98.40
OSCAEP20	2020	£85.00	£102.00



Klass

shown on page 44



Model	Height A (mm)	Width B (mm)	Watts Δt 50°C	Btu's Δt 50°C	White Ex VAT	White Inc VAT
KLAS43	432	80	85	290	£23.03	£27.64
KLAS58	582	80	116	396	£23.40	£28.08
KLAS68	682	80	132	451	£24.11	£28.93
KLAS78	782	80	148	505	£27.53	£33.04
KLAS88	882	80	162	553	£35.94	£43.13

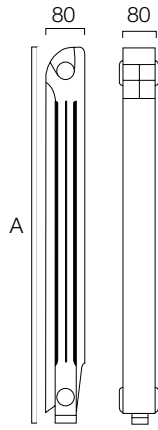

All stocked radiators have prices listed in purple and will be delivered in 3 - 5 working days.

Mix

shown on page 42



Model	Height A (mm)	Width B (mm)	Watts Δt 50°C	Btu's Δt 50°C	White Ex VAT	White Inc VAT
MIX39	390	80	86	294	£23.44	£28.13
MIX44	440	80	94	321	£23.93	£28.72
MIX59	590	80	123	420	£24.37	£29.24
MIX69	690	80	142	485	£25.24	£30.29
MIX79	790	80	161	549	£28.72	£34.46
MIX89	890	80	180	614	£37.76	£45.31

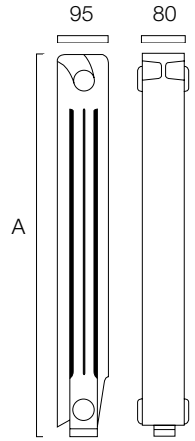

Vox

shown on page 43



Model	Height A (mm)	Width B (mm)	Watts Δt 50°C	Btu's Δt 50°C	White Ex VAT	White Inc VAT
VOX44	440	80	95	324	£23.93	£28.72
VOX59	590	80	127	433	£24.37	£29.24
VOX69	690	80	146	498	£25.24	£30.29
VOX79	790	80	164	560	£28.72	£34.46
VOX89	890	80	181	618	£37.76	£45.31

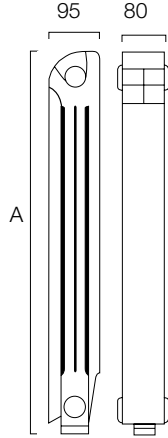

Ekos 95

shown on page 45



Model	Height A (mm)	Width B (mm)	Watts Δt 50°C	Btu's Δt 50°C	White Ex VAT	White Inc VAT
EKOS9556	568	50	61	208	£20.78	£24.94
EKOS9566	668	50	69	235	£21.25	£25.50
EKOS9576	768	50	78	266	£23.24	£27.89
EKOS9586	868	50	87	297	£27.03	£32.44

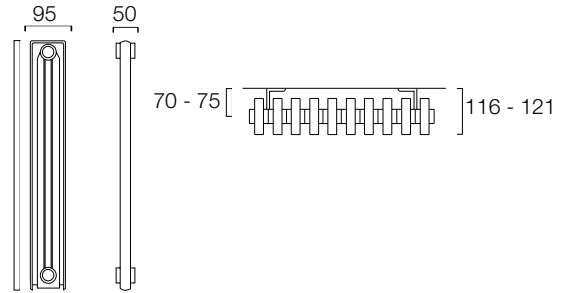

Ekos 130

shown on page 45



Model	Height A (mm)	Width B (mm)	Watts Δt 50°C	Btu's Δt 50°C	White Ex VAT	White Inc VAT
EKOS13068	683	50	87	297	£25.75	£30.90
EKOS13088	883	50	108	369	£32.15	£38.58

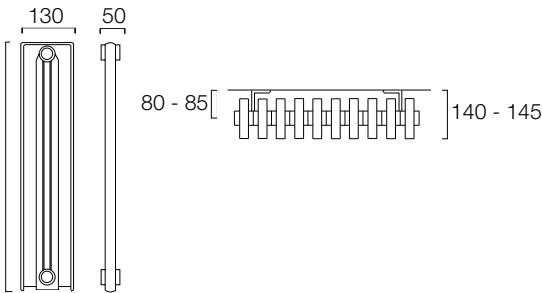

Ekos Extra

shown on page 45



Model	Height A (mm)	Width B (mm)	Watts Δt 50°C	Btu's Δt 50°C	White Ex VAT	White Inc VAT
EKOSE97	970	50	101	345	£32.03	£38.44
EKOSE10	1070	50	109	372	£35.32	£42.38
EKOSE12	1270	50	126	430	£46.71	£56.05
EKOSE14	1470	50	143	488	£57.98	£69.58
EKOSE16	1670	50	160	546	£65.08	£78.10
EKOSE18	1870	50	178	608	£70.25	£84.30
EKOSE20	2070	50	196	669	£78.31	£93.97

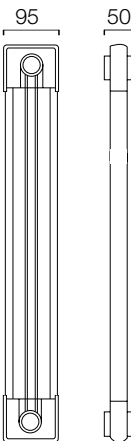

Aluminium pipe centres

Aluminium	Pipe centres left to right	Pipe centres from wall	Depth from wall
Vip	number of sections x 80mm + 28mm bushes + valves	70mm - 75mm	116mm - 121mm
Oscar	number of sections x 80mm + 28mm bushes + valves	70mm - 75mm	116mm - 121mm
Vox	number of sections x 80mm + 28mm bushes + valves	70mm - 75mm	116mm - 121mm
Klass	number of sections x 80mm + 28mm bushes + valves	70mm - 75mm	101mm - 106mm
Mix	number of sections x 80mm + 28mm bushes + valves	70mm - 75mm	116mm - 121mm
Ekos 95	number of sections x 50mm + 28mm bushes + valves	70mm - 75mm	116mm - 121mm
Ekos 130	number of sections x 50mm + 28mm bushes + valves	80mm - 85mm	140mm - 145mm
Ekos Extra	number of sections x 50mm + 28mm bushes + valves	70mm - 75mm	116mm - 121mm

Automatic bleed valve included with these radiators except the Vip and Oscar Royale

Pillar shown on page 50



Model	Height A (mm)	Width B (mm)	Watts Δt 50°C	Btu's Δt 50°C	Brushed Stainless Steel Ex VAT	Brushed Stainless Steel Inc VAT
PILLV1525	1500	250	490	1672	£1,039.00	£1,246.80
PILLV1534	1500	345	713	2435	£1,341.00	£1,609.20
PILLV1544	1500	440	937	3198	£1,642.00	£1,970.40
PILLV1825	1800	250	588	2006	£1,219.00	£1,462.80
PILLV1834	1800	345	860	2936	£1,542.00	£1,850.40
PILLV1844	1800	440	1133	3867	£1,892.00	£2,270.40
PILLV2025	2000	250	653	2229	£1,288.00	£1,545.60
PILLV2034	2000	345	958	3271	£1,673.00	£2,007.60
PILLV2044	2000	440	1264	4313	£2,055.00	£2,466.00

Pillar	Pipe centres left to right	Pipe centres from wall	Depth from wall
Pillar	width + valves	100mm	130mm

Please Note:

These Stainless Steel radiators can be very heavy and require suitable, structural support and at least 2 people to install.

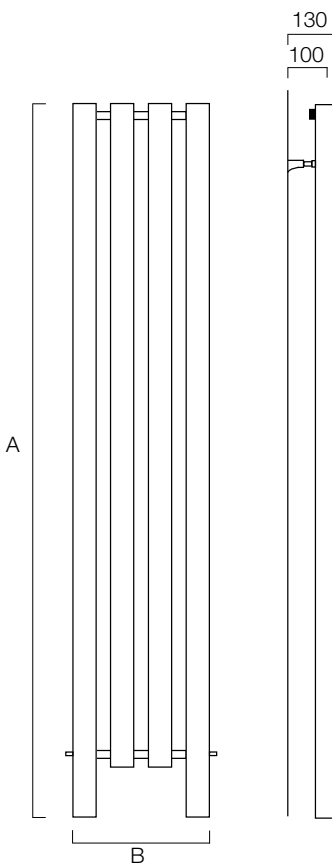

All stocked radiators have prices listed in purple and will be delivered in 3 - 5 working days.

Omega shown on pages 48 - 49



Omega Vertical

Model	Height A (mm)	Width B (mm)	Watts Δt 50°C	Btu's Δt 50°C	Brushed Stainless Steel Ex VAT	Brushed Stainless Steel Inc VAT
OMEGV7050	700	508	702	2396	£981.00	£1,177.20
OMEGV7059	700	598	830	2832	£1,161.00	£1,393.20
OMEGV1550	1500	508	1505	5135	£1,352.00	£1,622.40
OMEGV1559	1500	598	1778	6068	£1,564.00	£1,876.80
OMEGV1841	1800	418	1477	5041	£1,267.00	£1,520.40
OMEGV1850	1800	508	1805	6161	£1,511.00	£1,813.20
OMEGV1859	1800	598	2134	7282	£1,754.00	£2,104.80

Omega Horizontal

Model	Height A (mm)	Width B (mm)	Watts Δt 50°C	Btu's Δt 50°C	Brushed Stainless Steel Ex VAT	Brushed Stainless Steel Inc VAT
OMEGH4510	459	1000	912	3112	£1,044.00	£1,252.80
OMEGH6310	639	1000	1277	4357	£1,373.00	£1,647.60

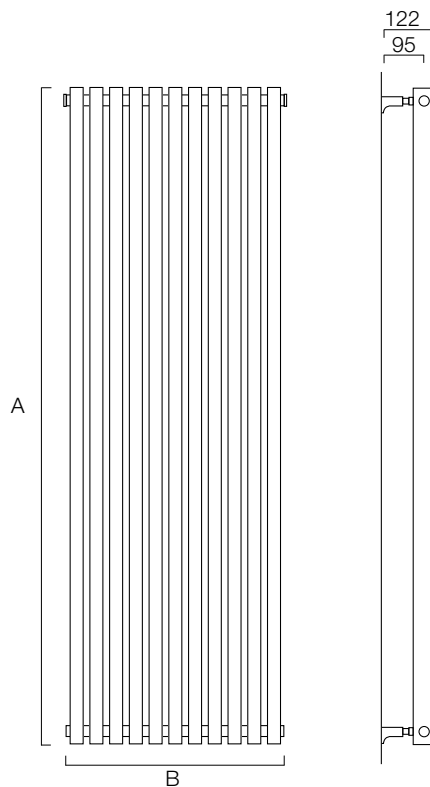
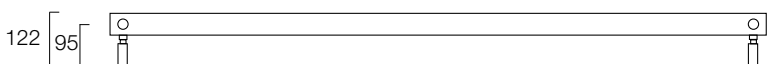
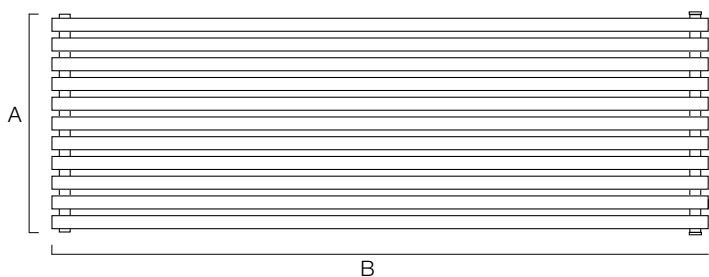

Omega	Pipe centres left to right	Pipe centres from wall	Depth from wall
Omega vertical	width + valves	95mm	122mm
Omega horizontal	width - 60mm	95mm	122mm

Please Note:

These Stainless Steel radiators can be very heavy and require suitable, structural support and at least 2 people to install.



Torus

shown on pages 52 - 53



Model	Height A (mm)	Width B (mm)	Watts Δt 50°C	Btu's Δt 50°C	Brushed Stainless Steel Ex VAT	Brushed Stainless Steel Inc VAT
TORUV7558	750	585	921	3143	£1,537.00	£1,844.40
TORUV7590	750	900	1429	4877	£2,109.00	£2,530.80
TORUV1834	1800	340	1325	4522	£1,373.00	£1,647.60
TORUV1844	1800	445	1768	6034	£1,903.00	£2,283.60

Torus	Pipe centres left to right	Pipe centres from wall	Depth from wall
Torus	width + valves	100mm - 115mm	130mm - 145mm

Please Note:

These Stainless Steel radiators can be very heavy and require suitable, structural support and at least 2 people to install.

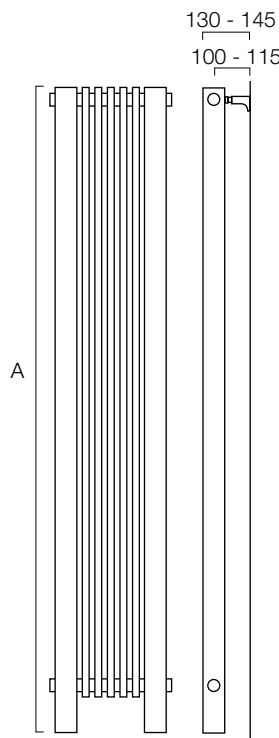

All stocked radiators have prices listed in purple and will be delivered in 3 - 5 working days.

Porta

shown on page 51



Model	Height A (mm)	Width B (mm)	Watts Δt 50°C	Btu's Δt 50°C	Brushed Stainless Steel Ex VAT	Brushed Stainless Steel Inc VAT
PORTH5810	580	1060	610	2081	£909.00	£1,090.80
PORTH5812	580	1260	713	2431	£951.00	£1,141.20
PORTH5815	580	1560	866	2959	£1,014.00	£1,216.80
PORTH7310	730	1060	748	2552	£1,059.00	£1,270.80
PORTH7312	730	1260	873	2980	£1,113.00	£1,335.60
PORTH7315	730	1560	1061	3622	£1,179.00	£1,414.80

Porta	Pipe centres left to right	Pipe centres from wall	Depth from wall
Porta	width + valves	75mm - 90mm	110mm - 125mm

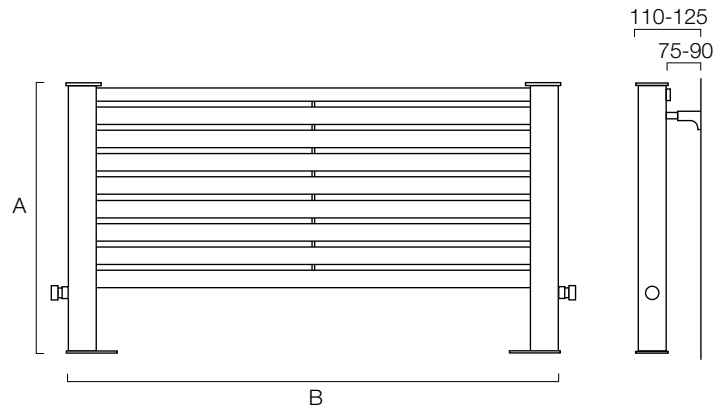

Valeta

shown on page 47



Model	Height A (mm)	Width B (mm)	Watts Δt 50°C	Btu's Δt 50°C	Brushed Stainless Steel Ex VAT	Brushed Stainless Steel Inc VAT
VALEV1529	1500	290	513	1751	£626.00	£751.20
VALEV1539	1500	390	684	2334	£685.00	£822.00
VALEV1549	1500	490	855	2918	£754.00	£904.80
VALEV1829	1800	290	616	2101	£699.00	£838.80
VALEV1839	1800	390	821	2801	£768.00	£921.60
VALEV1849	1800	490	1026	3501	£848.00	£1,017.60
VALEV2029	2000	290	684	2334	£737.00	£884.40
VALEV2039	2000	390	912	3112	£844.00	£1,012.80
VALEV2049	2000	490	1140	3890	£931.00	£1,117.20

Valeta	Pipe centres left to right	Pipe centres from wall	Depth from wall
Valeta	width - 40mm	86mm - 94mm	114mm - 122mm

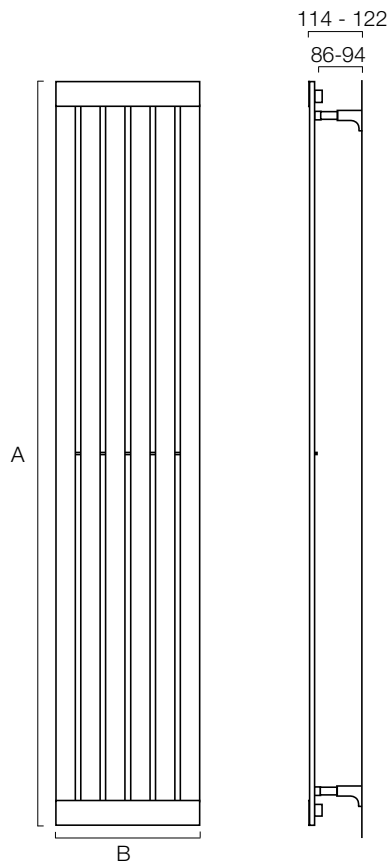

Ancona[®] Range

 shown on pages 54 - 62 (for quick introduction see page 138)

Ordering your Ancona

The Ancona range is incredibly versatile with literally hundreds of possible sizes, in a choice of 4 mounting options. The Ancona Made to Order range also offers a choice of 199 colours.

- All prices and outputs are given per section
 - Price per section includes plugs, bushes, air vent & wall ties.
 - Please specify with Cast Feet, Wall Brackets or Welded Feet when you place your order.
- These simple steps will help you choose a product that matches your requirements.

1 – Calculate the output & number of radiators

To find the output you require for each radiator first work out the heat output for your room. For a more detailed explanation please see pages 160 - 161 or visit our website at www.theradiatorcompany.co.uk

If you have a large room, divide this number by the total number of radiators you need in the room. e.g. a lounge 16' x 20' x 8' ceilings = a volume of 2560 x 6 = 15,360 BTUs. Two radiators would be required which = 7680 BTUs each. Your installer will also be able to help you decide this, if required. We also list the outputs in Watts.

2 – Choose the number of Columns

Made to Order Ancona's are available in a choice of five column depths; 2, 3, 4, 5 and 6 columns. More columns equals greater depth, bigger water content and therefore a higher output, however choice is generally down to aesthetics.

Stock Ancona's are available in a choice of three column depths, 2, 3 and 4 columns.

3 – Choose a Height

Made to Order Ancona's: All of the column depths are available in a range of 15 heights. Decide on a section height that matches the size you require, allowing an additional 100mm for cast feet or 105mm for welded feet.

Stock Ancona's: Column depths are available in a range of heights, from 300mm to 1800mm. Decide on a section height that matches the size you require, allowing an additional 100mm for cast feet. For the Stocked Ancona's with slip on welded feet please allow an extra 80mm in height.

4 – Calculate the number of sections you require

Listed next to each section height under 'BTUs/Watts' will be the output each section gives. Divide your required output by this number to find the total number of sections needed to match the output; e.g. if you have chosen a 3 column 600mm high then 7680 BTUs divided by 205 BTUs per section = 38 sections.

5 – Size the finished product & double check

Each section regardless of how many columns it has is 46mm wide, therefore a 38 section radiator will equal 38 x 46mm = 1748mm wide, plus 24mm bushes plus valves. If this is too wide then either increase the height of each section or choose a section with more columns. For example; 3 column 750mm high = 7680 BTUs divided by 256 BTUs per section = 30 sections = 1380mm wide.

or 4 column 600mm high = 7680 BTUs divided by 263 BTUs per section = 29 sections = 1343mm wide.

6 – Choose the mounting option

Made to Order Ancona's: Your Ancona can be supplied in one of three mounting options, either with Welded Feet, with Cast Feet or with Wall Brackets.

- With Wall brackets you have the freedom to position your Ancona at any height - see page 59 / 137.
- Cast feet give the finished radiator a traditional look - see page 56 / 137.
- Welded feet will give you a more contemporary feel - see page 57 / 137.
- Select required option and add to section price; see tables on page 137.

Stock Ancona's: Can be supplied in one of three mounting options, either with Slip on Welded Feet, Cast Feet or with Wall Brackets. All mounting options are supplied with the necessary number of wall ties.

7 - Choose your colour

Made to Order Ancona's: Your Ancona can be supplied in any one of the 188 RAL colours or 11 special finishes from Colour Group 9, see page 55 for more information on colour options. Stock Ancona's: Available in RAL 9010 only.

8 - Place your order

Made to Order Ancona's: Place your order using the product code x No. of sections needed & noting the mounting option and the colour e.g. ANCO3C90 X 12 Sections with Cast Feet in RAL 9005 (or white)

Stock Ancona's: When placing your order for Sectional Stock Ancona use the product code x No. of sections needed & noting the mounting option e.g. ANCS3C60W X 12 Sections with Wall Brackets.

Please note: Due to transport and handling restrictions, Made to Order Anconas are supplied factory assembled up to a maximum of 50 sections on 2, 3 or 4 column, 40 sections on 5 & 6 column, however all radiators over this number of sections or 60 kgs are delivered in two separate battery sizes that will require joining on site with appropriate nipple and gasket fittings (which will be supplied) using appropriate tooling (which can be supplied on a sale or return basis). Stock Ancona's are supplied pre-assembled up to a maximum of 40 sections or 60kg in weight. For radiators outside these parameters please consult the sales office to discuss your requirements. All Ancona's come supplied as a finished radiator with ½" B.O.E. (Bottom Opposite End) connections as standard. Please call us on **01342 302250** if you need any further information or help with specifying your Ancona.

Mounting Options

Please choose one of the following 3 mounting options and specify at time of order.
The correct number of wall ties are supplied with each order; extra wall ties can be ordered if required.

Please note that the corresponding kit number that applies to the tables above will be listed on your Order Acknowledgement.

Ancona Kits for Cast Feet

Note: Please remember to add 100mm to the height of the Ancona section you have chosen if you are using Cast Feet.

We recommend the following number of Cast Feet and Wall Ties per number of sections and these will be priced and supplied with your order unless otherwise specified.

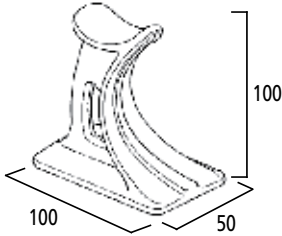

3 - 20 Sections
2 - 6 column = 2 Cast Feet & 2 Wall Ties
21 - 30 Sections
2 - 6 column = 3 Cast Feet & 3 Wall Ties
31 - 40 Sections
2 - 6 column = 4 Cast Feet & 4 Wall Ties
41 - 50 Sections
2 - 6 column = 5 Cast Feet & 5 Wall Ties

Model	Number of feet	White Ex VAT	Colours Ex VAT	White Inc VAT	Colours Inc VAT
PPANFMK	2	£39.00	£47.00	£46.80	£56.40
PPANFMK	3	£52.00	£62.00	£62.40	£74.40
PPANFMK	4	£79.00	£95.00	£94.80	£114.00
PPANFMK	5	£92.00	£110.00	£110.40	£132.00

Ancona Kits for Welded Feet

Note: Please remember to add 105mm to the height of the Ancona section you have chosen if you are using Welded Feet.

Ancona's with Welded Feet are supplied with the correct number of feet (see below); additional Welded Feet cannot be ordered.

2 column

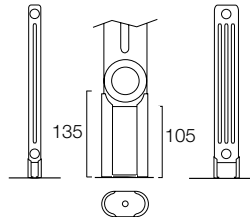

3, 4, 5, 6 column

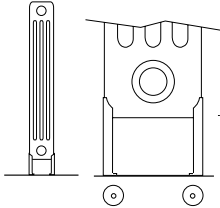

2 - 12 Sections
2 - 6 column = 2 Welded feet & 2 Wall Ties
13 - 23 Sections
2 - 4 column = 2 Welded feet & 2 Wall Ties
5 & 6 column = 3 Welded Feet & 3 Wall Ties
24 - 41 Sections
2 - 4 column = 3 Welded feet & 3 Wall Ties
5 & 6 column = 4 Welded feet & 4 Wall Ties
42 - 50 Sections
2 - 4 column = 4 Welded feet & 4 Wall Ties
5 & 6 column = 5 Welded feet & 5 Wall Ties

Model	Number of feet	White Ex VAT	Colours Ex VAT	White Inc VAT	Colours Inc VAT
PPANWFK	2	£95.00	£118.00	£114.00	£141.60
PPANWFK	3	£114.00	£144.00	£136.80	£172.80
PPANWFK	4	£146.00	£184.00	£175.20	£220.80
PPANWFK	5	£160.00	£237.00	£192.00	£284.40

Ancona Kits for Wall Brackets

Note: Ancona's with Wall Brackets can be positioned at any height; brackets are supplied with raw plugs.

We recommend the following number of Wall Brackets and Wall Ties per number of sections and these will be priced and supplied with your order unless otherwise specified.

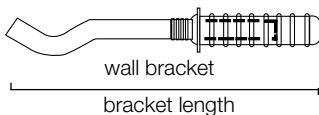

2 Column = 165mm
3 - 4 Column = 215mm
5 - 6 Column = 255mm

Wall tie - adjusts from 33-43mm



3 - 20 Sections
2 - 6 column = 2 Wall Brackets & 2 Wall Ties
21 - 30 Sections
2 - 6 column = 3 Wall Brackets & 3 Wall Ties
31 - 40 Sections
2 - 6 column = 4 Wall Brackets & 4 Wall Ties
41 - 50 Sections
2 - 6 column = 5 Wall Brackets & 5 Wall Ties

Model	Number of brackets	White Ex VAT	Colours Ex VAT	White Inc VAT	Colours Inc VAT
PPANWBK	2	£35.00	£42.00	£42.00	£50.40
PPANWBK	3	£44.00	£54.00	£52.80	£64.80
PPANWBK	4	£72.00	£87.00	£86.40	£104.40
PPANWBK	5	£82.00	£98.00	£98.40	£117.60



All prices & outputs are given per section; please see the section on page 135 'Ordering your Ancona', for details on how to order.

2 Column - 64mm Deep

Model	Height A (mm)	Weight Kg	Watts Δt 50°C	Btu's Δt 50°C	White Ex VAT	Colours Ex VAT	White Inc VAT	Colours Inc VAT
ANCO2C22	220	0.42	16	55	£15.95	£20.52	£19.14	£24.62
ANCO2C30	300	0.53	22	75	£16.14	£20.76	£19.37	£24.91
ANCO2C40	400	0.67	28	96	£16.33	£21.00	£19.60	£25.20
ANCO2C45	450	0.74	33	113	£16.39	£21.08	£19.67	£25.30
ANCO2C50	500	0.81	37	126	£16.46	£21.18	£19.75	£25.42
ANCO2C55	550	0.88	41	140	£16.65	£21.39	£19.98	£25.67
ANCO2C60	600	0.95	44	150	£16.74	£21.52	£20.09	£25.82
ANCO2C75	750	1.16	55	188	£17.40	£22.38	£20.88	£26.86
ANCO2C90	900	1.38	67	229	£18.74	£24.11	£22.49	£28.93
ANCO2C10	1000	1.52	73	249	£20.48	£26.33	£24.58	£31.60
ANCO2C12	1200	1.80	86	293	£26.12	£33.61	£31.34	£40.33
ANCO2C15	1500	2.22	106	362	£34.90	£44.90	£41.88	£53.88
ANCO2C18	1800	2.64	125	427	£40.96	£52.70	£49.15	£63.24
ANCO2C20	2000	2.92	140	478	£45.38	£58.37	£54.46	£70.04
ANCO2C25	2500	3.63	174	594	£53.46	£68.80	£64.15	£82.56

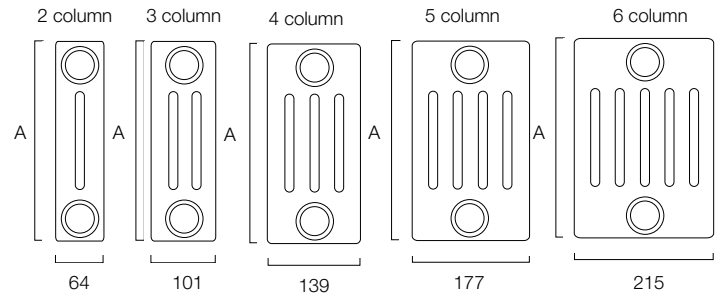

Pipe Centres for all Anconas with Cast Feet, Welded Feet or Wall Brackets are;

Pipe centres left to right = number of sections x 46mm plus 24mm (12mm each) for bushes plus valves.

Pipe centres from wall (based on adjustable wall ties)	2 Column = 65mm to 75mm 3 Column = 84mm to 94mm 4 Column = 102mm to 112mm 5 Column = 121mm to 131mm 6 Column = 140mm to 150mm
--	---

Automatic bleed valve included with these radiators

3 column - 101mm Deep

Model	Height A (mm)	Weight Kg	Watts Δt 50°C	Btu's Δt 50°C	White Ex VAT	Colours Ex VAT	White Inc VAT	Colours Inc VAT
ANCO3C22	220	0.62	22	75	£18.47	£23.76	£22.16	£28.51
ANCO3C30	300	0.79	31	106	£18.67	£24.02	£22.40	£28.82
ANCO3C40	400	1.00	41	140	£18.84	£24.26	£22.61	£29.11
ANCO3C45	450	1.11	46	157	£18.90	£24.31	£22.68	£29.17
ANCO3C50	500	1.21	51	174	£18.98	£24.41	£22.78	£29.29
ANCO3C55	550	1.32	55	188	£19.08	£24.54	£22.90	£29.45
ANCO3C60	600	1.43	60	205	£19.19	£24.65	£23.03	£29.58
ANCO3C75	750	1.74	75	256	£20.84	£26.88	£25.01	£32.26
ANCO3C90	900	2.06	89	304	£22.64	£29.15	£27.17	£34.98
ANCO3C10	1000	2.27	98	334	£26.81	£34.50	£32.17	£41.40
ANCO3C12	1200	2.69	116	396	£35.14	£45.20	£42.17	£54.24
ANCO3C15	1500	3.33	143	488	£37.45	£62.00	£44.94	£74.40
ANCO3C18	1800	3.96	170	580	£54.09	£69.56	£64.91	£83.47
ANCO3C20	2000	4.38	189	645	£60.14	£77.37	£72.17	£92.84
ANCO3C25	2500	5.44	236	805	£71.66	£92.19	£85.99	£110.63

4 column - 139mm Deep

Model	Height A (mm)	Weight Kg	Watts Δt 50°C	Btu's Δt 50°C	White Ex VAT	Colours Ex VAT	White Inc VAT	Colours Inc VAT
ANCO4C22	220	0.82	29	99	£22.15	£28.49	£26.58	£34.19
ANCO4C30	300	1.04	40	136	£22.52	£28.96	£27.02	£34.75
ANCO4C40	400	1.32	52	177	£22.77	£29.28	£27.32	£35.14
ANCO4C45	450	1.46	58	198	£23.02	£29.61	£27.62	£35.53
ANCO4C50	500	1.6	65	222	£23.16	£29.80	£27.79	£35.76
ANCO4C55	550	1.74	71	242	£23.56	£30.29	£28.27	£36.35
ANCO4C60	600	1.89	77	263	£23.75	£30.54	£28.50	£36.65
ANCO4C75	750	2.31	95	324	£24.94	£32.08	£29.93	£38.50
ANCO4C90	900	2.73	112	382	£27.62	£35.51	£33.14	£42.61
ANCO4C10	1000	3.01	124	423	£30.90	£39.75	£37.08	£47.70
ANCO4C12	1200	3.58	147	502	£44.76	£57.60	£53.71	£69.12
ANCO4C15	1500	4.42	180	614	£54.24	£69.79	£65.09	£83.75
ANCO4C18	1800	5.26	214	730	£65.37	£84.12	£78.44	£100.94
ANCO4C20	2000	5.83	237	809	£72.25	£92.93	£86.70	£111.52
ANCO4C25	2500	7.24	295	1007	£86.45	£111.21	£103.74	£133.45

5 Column - 177mm Deep

Model	Height A (mm)	Weight Kg	Watts Δt 50°C	Btu's Δt 50°C	White Ex VAT	Colours Ex VAT	White Inc VAT	Colours Inc VAT
ANCO5C22	220	1.02	35	119	£23.68	£30.47	£28.42	£36.56
ANCO5C30	300	1.30	48	164	£24.44	£31.43	£29.33	£37.72
ANCO5C40	400	1.65	64	218	£25.63	£32.97	£30.76	£39.56
ANCO5C45	450	1.83	72	246	£26.26	£33.82	£31.51	£40.58
ANCO5C50	500	2.00	80	273	£26.35	£33.89	£31.62	£40.67
ANCO5C55	550	2.18	87	297	£27.51	£35.36	£33.01	£42.43
ANCO5C60	600	2.36	95	324	£27.88	£35.85	£33.46	£43.02
ANCO5C75	750	2.88	117	399	£29.16	£37.96	£34.99	£45.55
ANCO5C90	900	3.41	138	471	£33.61	£43.24	£40.33	£51.89
ANCO5C10	1000	3.76	151	515	£38.23	£49.18	£45.88	£59.02
ANCO5C12	1200	4.47	179	611	£50.54	£65.01	£60.65	£78.01
ANCO5C15	1500	5.52	215	734	£65.48	£84.24	£78.58	£101.09
ANCO5C18	1800	6.58	256	873	£76.57	£101.49	£91.88	£121.79
ANCO5C20	2000	7.28	282	962	£86.45	£111.21	£103.74	£133.45
ANCO5C25	2500	9.04	347	1184	£104.50	£134.46	£125.40	£161.35

6 column - 215mm Deep

Model	Height A (mm)	Weight Kg	Watts Δt 50°C	Btu's Δt 50°C	White Ex VAT	Colours Ex VAT	White Inc VAT	Colours Inc VAT
ANCO6C22	220	1.23	42	143	£29.40	£37.82	£35.28	£45.38
ANCO6C30	300	1.57	57	194	£30.29	£38.98	£36.35	£46.78
ANCO6C40	400	1.99	75	256	£31.13	£40.07	£37.36	£48.08
ANCO6C45	450	2.20	84	287	£31.98	£41.14	£38.38	£49.37
ANCO6C50	500	2.41	94	321	£32.27	£41.51	£38.72	£49.81
ANCO6C55	550	2.62	103	351	£33.18	£42.67	£39.82	£51.20
ANCO6C60	600	2.83	113	386	£33.79	£43.55	£40.55	£52.26
ANCO6C75	750	3.47	137	467	£35.50	£45.68	£42.60	£54.82
ANCO6C90	900	4.10	163	556	£41.72	£53.69	£50.06	£64.43
ANCO6C10	1000	4.52	180	614	£45.71	£58.84	£54.85	£70.61
ANCO6C12	1200	5.37	209	713	£62.05	£79.81	£74.46	£95.77
ANCO6C15	1500	6.63	250	853	£78.97	£101.61	£94.76	£121.93
ANCO6C18	1800	7.90	297	1013	£94.84	£121.99	£113.81	£146.39
ANCO6C20	2000	8.75	330	1126	£104.70	£134.70	£125.64	£161.64
ANCO6C25	2500	10.86	403	1375	£125.38	£161.30	£150.46	£193.56



Ancona[®] Bench Seat shown on page 58



Model	Height A (mm)	Width B (mm)	Watts Δt 50°C	Btu's Δt 50°C	White Ex VAT	Colours Ex VAT	White Inc VAT	Colours Inc VAT
ANCB4S3813	388	1300	836	2852	£690.00	£897.00	£828.00	£1,076.40
ANCB5S4313	434	1300	1045	3566	£779.00	£1,013.00	£934.80	£1,215.60
ANCB6S4813	480	1300	1254	4279	£871.00	£1,132.00	£1,045.20	£1,358.40
ANCB4S3816	388	1600	1000	3412	£799.00	£1,039.00	£958.80	£1,246.80
ANCB5S4316	434	1600	1250	4265	£891.00	£1,158.00	£1,069.20	£1,389.60
ANCB6S4816	480	1600	1500	5118	£1,004.00	£1,306.00	£1,204.80	£1,567.20
ANCB4S3819	388	1900	1188	4053	£876.00	£1,138.00	£1,051.20	£1,365.60
ANCB5S4319	434	1900	1485	5067	£1,008.00	£1,310.00	£1,209.60	£1,572.00
ANCB6S4819	480	1900	1792	6114	£1,144.00	£1,486.00	£1,372.80	£1,783.20
ANCB4S3821	388	2100	1320	4504	£941.00	£1,223.00	£1,129.20	£1,467.60
ANCB5S4321	434	2100	1650	5630	£1,087.00	£1,358.00	£1,304.40	£1,629.60
ANCB6S4821	480	2100	1980	6756	£1,235.00	£1,606.00	£1,482.00	£1,927.20
ANCB4S3826	388	2600	1612	5500	£1,154.00	£1,500.00	£1,384.80	£1,800.00
ANCB5S4326	434	2600	2015	6875	£1,331.00	£1,731.00	£1,597.20	£2,077.20
ANCB6S4826	480	2600	2418	8250	£1,515.00	£1,969.00	£1,818.00	£2,362.80

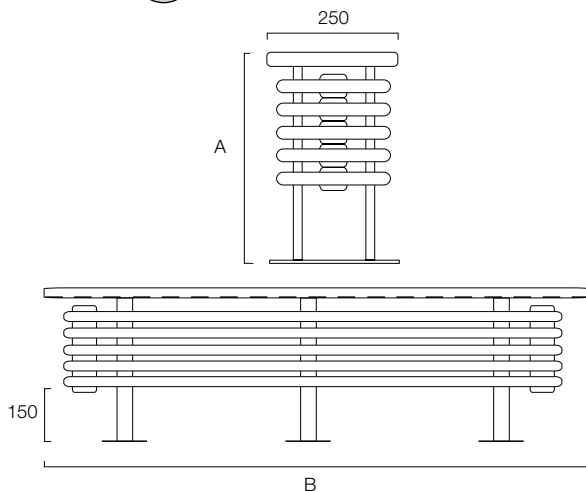

Please note: Bench seats over 1300mm wide will be supplied with 3 feet.

Supplied as frame only, inner seat not included.

Pipe centres = width - 170mm

Ancona[®] sectional stocked in white



shown on pages 60 - 62

Ordering your Ancona Sectional (for detailed introduction see page 135)

- All prices and outputs are given per section in the tables shown below
 - Price per section includes plugs, bushes, spring diverter, air vent and wall ties
- Decide on the output and rough dimensions of the radiator(s) you need for your room(s)
 - Choose a suitable Column depth (2, 3 or 4 column, see page below) & Height per section
 - Calculate the number of Sections you need by dividing the required BTU / Watt output with the BTU / Watt output per section.
 - Choose a Mounting Option; Slip on welded feet, Wall Brackets or Cast Feet (please specify at the time of order); see recommendations below.
 - Double check all dimensions; Sections are 46mm wide, therefore radiator length is "no. of Sections x 46mm + 24mm for bushes + valves"; the height is the Section height, but remember to also add 100mm for the Cast Feet & a similar clearance for pipework if using Wall Brackets.
 - Place your order by using the Sectional Model Code x No. of Sections needed and noting the Mounting Option e.g ANCS3C60W x 18 Sections with Wall Brackets

For a more detailed explanation of the above see page 135, for Column depths see bottom of this page and for pipe centres see bottom of page 139.

Non stock radiators are bespoke & made to order. Delivery times may be extended during factory holiday closures in Jul/Aug & Dec. Delivery times will be confirmed at time of order.

Ancona[®] sectional stocked in white



All stocked radiators have prices listed in purple and will be delivered in 3 - 5 working days.

shown on pages 60 - 62

2 column

Model	Height A (mm)	Weight Kg	Watts Δt 50°C	Btu's Δt 50°C	White Ex VAT	White Inc VAT
ANCS2C60W	600	0.95	44	150	£16.37	£19.64
ANCS2C75W	750	1.16	55	188	£17.01	£20.41
ANCS2C18W	1800	2.64	125	427	£34.12	£40.94

Slip on welded feet

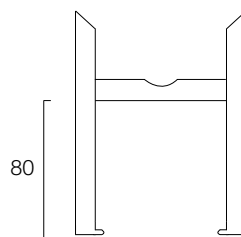

3 column

Model	Height A (mm)	Weight Kg	Watts Δt 50°C	Btu's Δt 50°C	White Ex VAT	White Inc VAT
ANCS3C50W	500	1.21	51	174	£18.56	£22.27
ANCS3C60W	600	1.43	60	205	£18.76	£22.51
ANCS3C75W	750	1,74	75	256	£20.38	£24.46

Cast Feet

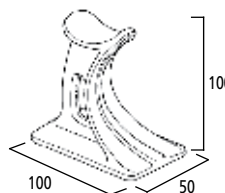

4 column

Model	Height A (mm)	Weight Kg	Watts Δt 50°C	Btu's Δt 50°C	White Ex VAT	White Inc VAT
ANCS4C30W	300	1.04	40	136	£22.01	£26.41
ANCS4C60W	600	1.89	77	263	£22.64	£27.17
ANCS4C75W	750	2.31	95	324	£23.21	£27.85

Wall Bracket

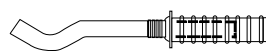

bracket length; 2 Column = 165mm
3-4 Column = 215mm

Ancona stocked sectional Mounting Options

Model	Description	Price Ex VAT	Price Inc VAT
PPSSFM01W	Cast feet white	£16.00	£19.20
PPSSSF	Slip on welded feet white	£29.00	£34.80
PPSSWB	Wall brackets white	£6.00	£7.20
PPSSWT01W	Wall ties white	£4.00	£4.80

Wall Ties



wall tie - adjusts from 33mm - 43mm

Wall Ties are included in the price & supplied as standard for all orders.

We recommend the following mounting options are used per section;

3 - 20 Sections	21 - 30 Sections	31 - 40 Sections
2 Cast Feet	3 Cast Feet	4 Cast Feet
2 Wall Brackets	3 Wall Brackets	4 Wall Brackets
2 Wall Ties	3 Wall Ties	4 Wall Ties
2 Slip on Welded Feet	3 Slip on Welded Feet	4 Slip on Welded Feet

If you require a different number of Cast Feet, Wall Brackets or Wall Ties, please specify at the time of order; otherwise we will ensure that we price and supply as above. Wall Ties are included in the price and supplied as standard for all orders.

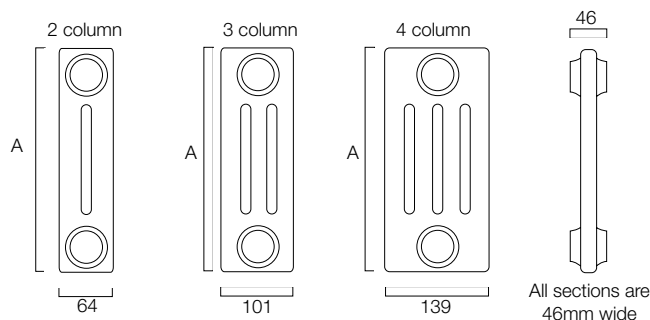

Pipe Centres for all Anconas with Slip on Feet, Cast Feet or Wall Brackets are;

Pipe centres left to right = number of sections x 46mm plus 24mm (12mm each) for bushes plus valves.

Pipe centres from wall (based on adjustable wall ties)

2 Column = 65mm to 75mm
3 Column = 84mm to 94mm
4 Column = 102mm to 112mm

Automatic bleed valve included with these radiators



Ordering your cast iron radiator



All stocked radiators have prices listed in purple and will be delivered in 3 - 5 working days.

shown on pages 63 - 67

- Prices and outputs for Bianco, Ludlow and Trieste are given per section, the Vecchia is shown in output per radiator.
- Price per section includes plugs, bushes & air vent.
- Please specify mounting option when you place your order.
- Wall ties are supplied as standard with Bianco and Ludlow radiators.

These simple steps will help you choose a Cast Iron Radiator that matches your requirements.

1 – Calculate the output & number of radiators

First find out the BTU requirement for your room, for a detailed explanation please see pages 160 - 161 or visit our website at www.theradiatorcompany.co.uk. Then identify the size of radiators required to provide enough the required heat; you may need more than one radiator to achieve this.

2 – Choose the number of Columns

Ludlow and Bianco Cast Iron radiators are available in a choice of 4 or 6 column depths, Trieste in 2 or 3 column. More columns equal greater depth, bigger water content and therefore a higher output. The Vecchia is only available in a 3 column option.

3 – Choose a Height

Decide on a section height that matches the size you require, allowing an additional 100mm for the Cast Foot or Paw Foot and 60mm for Footed End Sections.

4 – Calculate the number of sections you require

Listed next to each section height under 'BTUs/Watts' will be the output each section gives. Divide your required output by this number to find the total number of sections needed to match the output; e.g. if you have chosen a Ludlow 4 column 598mm high then 7115 BTUs divided by 317 BTUs per section = 23 sections. If this produces a radiator that is too wide select either a taller section or more columns; e.g. Ludlow 4 column 900 high= 7115 divided by 474 BTUs = 15 sections.

5 – Choose the mounting option

Cast iron Radiators are very heavy and we recommend they are floor mounted; if you wish to hang cast iron radiators on the wall you must ensure it is structurally sound enough to take the weight.

- Ludlow; available with footed end sections as standard, cast feet, paw feet or wall brackets.
- Bianco; available with standard cast feet as standard, paw feet or wall brackets.
- Vecchia; supplied with footed end sections only.
- Trieste; supplied with footed end sections only.

A suitable number of wall ties will be supplied with all mounting options on Ludlow and Bianco.

6 - Place your order

Please note: Cast Iron radiators come assembled up to a maximum of 10 sections or 100kg in weight, larger radiators must be joined on site following manufacturer's instructions. Joining keys are available for a deposit, refundable on return.

All Cast Iron radiators come supplied as a finished radiator with ½" B.O.E. (Bottom Opposite End) connections as standard.

Please call us on **01342 302250** if you need any further information or help with specifying your Cast Iron radiator.

Bianco & Ludlow Mounting Options

We recommend the following mounting options are used per section;

3 - 15 Sections	16 - 25 Sections	26 - 40 Sections
2 Feet/Footed Sections	3 Feet/Footed Sections	4 Feet/Footed Sections
3 Wall Brackets	4 Wall Brackets	6 Wall Brackets
2 Wall Ties	3 Wall Ties	4 Wall Ties

For more than 40 sections please talk to our Customer Services team.

If you require a different number of Feet, Wall Brackets or Wall Ties, please specify at the time of order; otherwise we will ensure that we price and supply as above.

Wall Ties are included in the price and supplied as standard for all orders.

Please specify at time of order.

Model	Description	Price Ex VAT	Price Inc VAT
PPCIFM01	Cast foot unpainted	£15.00	£18.00
PPCIFM01W	Cast foot white	£20.00	£24.00
PPTPCIFM	Cast Iron Paw foot unpainted	£20.00	£24.00
PPSSWB	Wall brackets white	£6.00	£7.20
PPCIWT01	Wall ties white	£4.00	£4.80
PPASMKEY	Joining Key 1" x 300mm/600mm/900mm	£49.00	£58.80

Joining Keys & instructions will be provided for all orders over 10 sections and the Joining Key is refundable on return.

Bianco

shown on page 64



All stocked radiators have prices listed in purple and will be delivered in 3 - 5 working days.

For help choosing the right size Bianco please see note above.

4 Column

Model	Height A (mm)	Width B (mm)	Watts Δt 50°C	Btu's Δt 50°C	Primer Ex VAT	Primer Inc VAT
BIAN4C57	571	55	80	271	£39.95	£47.94
BIAN4C66	665	55	91	311	£43.41	£52.09
BIAN4C87	871	55	116	394	£47.86	£57.43

6 Column

Model	Height A (mm)	Width B (mm)	Watts Δt 50°C	Btu's Δt 50°C	Primer Ex VAT	Primer Inc VAT
BIAN6C66	665	55	136	464	£54.54	£65.45
BIAN6C87	871	55	170	580	£65.67	£78.80

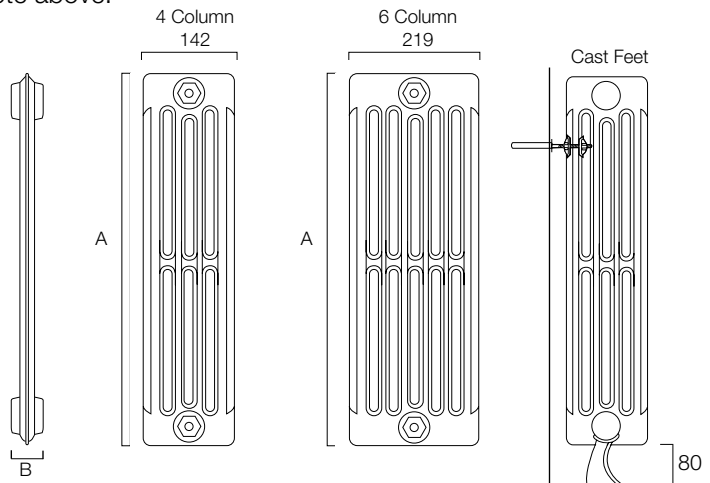

Bianco	Pipe centres left to right	Pipe centres from wall
4 Column	55 x number of sections + 24mm bushes + valves	121mm - 141mm
6 Column	55 x number of sections + 24mm bushes + valves	160mm - 180mm

Bianco Mounting Options;
The Bianco will always be quoted with optional Cast Feet; if you require Paw Feet or Wall Brackets instead please specify at time of order.

Important Note:
Bianco and Ludlow radiators are supplied from stock in primer finish only. Due to the weight, we can only supply complete or part assembled radiators up to a maximum of 10 sections. Radiators over 10 sections must be site assembled; appropriate nipples and gaskets are supplied.

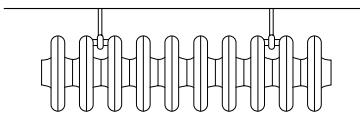

Minimum distance from wall = 50mm
Maximum distance = 70mm

Ludlow

shown on page 65



4 Column

Model	Height A (mm)	Width B (mm)	Watts Δt 50°C	Btu's Δt 50°C	Primer Ex VAT	Primer Inc VAT
LUDL4C30	300	60	43	147	£14.61	£17.53
LUDL4C44	448	60	65	222	£19.10	£22.92
LUDL4C59	598	60	93	317	£24.72	£29.66
LUDL4C74	748	60	108	369	£31.46	£37.75
LUDL4C89	898	60	139	474	£37.08	£44.50

6 Column

Model	Height A (mm)	Width B (mm)	Watts Δt 50°C	Btu's Δt 50°C	Primer Ex VAT	Primer Inc VAT
LUDL6C44	448	60	95	324	£28.09	£33.71
LUDL6C59	598	60	133	454	£35.96	£43.15

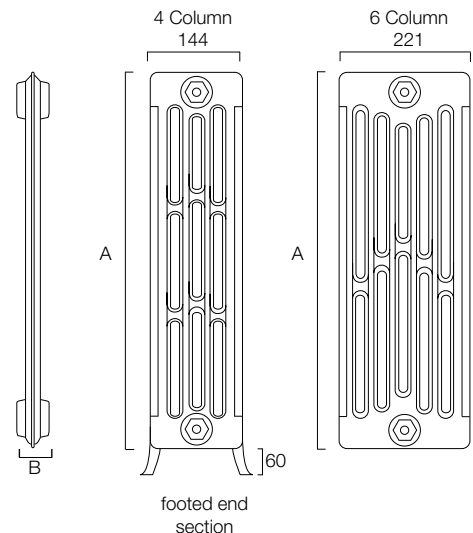

Ludlow	Pipe centres left to right	Pipe centres from wall
4 Column	60 x number of sections + 24mm bushes + valves	122mm - 142mm
6 Column	60 x number of sections + 24mm bushes + valves	161mm - 181mm

Ludlow Mounting Options;
The Ludlow will be supplied with footed end sections as standard; if you require optional Cast Feet, Paw Feet or Wall Brackets instead please specify at time of order.



Vecchia shown on page 66



All stocked radiators have prices listed in purple and will be delivered in 3 - 5 working days.

Model	Height A (mm)	Width B (mm)	Watts Δt 50°C	Btu's Δt 50°C	Price Ex VAT	Price Inc VAT
VECCB8346	838	461	863	2946	£886.00	£1,063.20
VECCB8361	838	615	1151	3928	£1,146.00	£1,375.20
VECCB8376	838	769	1438	4907	£1,407.00	£1,688.40

Vecchia	Pipe centres left to right	Pipe centres from wall
Vecchia	width + valves	As a free standing radiator, pipe centres from wall will depend on final position

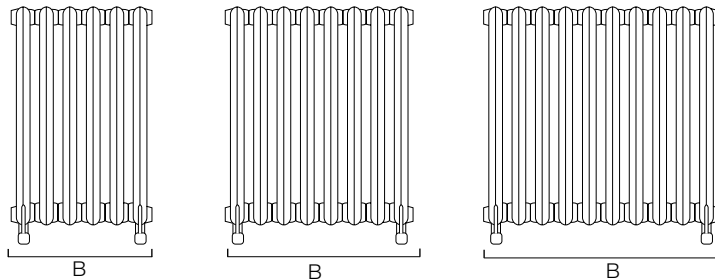
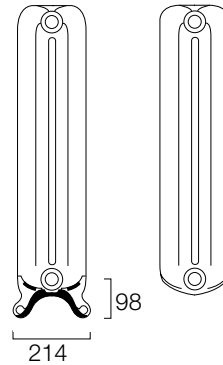

Vecchia Mounting Options;
The Vecchia is a free standing radiator and is supplied with footed end sections only.

Important Note:

The Vecchia is not a sectional product but is available in three popular sizes in a dark grey colour only. Vecchias are now supplied with 1/2" B.O.E. (Bottom Opposite End) connections as standard. T.B.S.E (Top Bottom Same End) connections are available as an option; please specify at time of order.

Trieste shown on page 67



For help choosing the right size Trieste please turn to page 140.

2 Column

Model	Height A (mm)	Width B (mm)	Watts Δt 50°C	Btu's Δt 50°C	Grey Primer Ex VAT	Grey Primer Inc VAT
TRIE2C66	661	76	130	444	£61.00	£73.20
TRIE2C76	760	76	143	488	£67.00	£80.40
TRIE2C95	955	76	168	573	£89.00	£106.80

3 Column

Model	Height A (mm)	Width B (mm)	Watts Δt 50°C	Btu's Δt 50°C	Grey Primer Ex VAT	Grey Primer Inc VAT
TRIE3C76	768	78	189	645	£70.00	£84.00
TRIE3C96	961	78	221	754	£92.00	£110.40

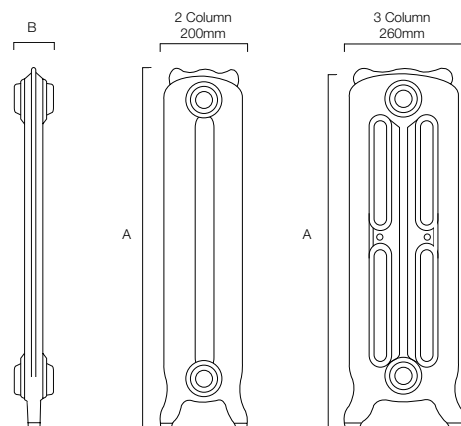

Trieste	Pipe centres left to right	Pipe centres from wall
2 Column	76 x number of sections + 24mm bushes + valves	150mm - 170mm
3 Column	78 x number of sections + 24mm bushes + valves	180mm - 200mm

Trieste Mounting Options;
The Trieste is a free standing radiator and is supplied with footed end sections only.

Ice Bagno Range shown on page 69



All stocked radiators have prices listed in purple and will be delivered in 3 - 5 working days.

Ice Bagno Vertical Polished Stainless Steel

Model	Height A (mm)	Width B (mm)	Watts Δt 50°C	Btu's Δt 50°C	Polished Stainless Steel Ex VAT	Polished Stainless Steel Inc VAT
ICEB/BS1245S	1220	465	400	1365	£1,043.00	£1,251.60
ICEB/BS1545S	1520	465	497	1696	£1,376.00	£1,651.20
ICEB/BS1560S	1520	615	662	2259	£1,479.00	£1,774.80
ICEB/BS1845S	1820	465	595	2031	£1,502.00	£1,802.40
ICEB/BS1860S	1820	615	793	2707	£1,594.00	£1,912.80
ICEB/BS2045S	2020	465	881	2253	£1,708.00	£2,049.60

Ice Bagno Vertical Matt White

Model	Height A (mm)	Width B (mm)	Watts Δt 50°C	Btu's Δt 50°C	White Ex VAT	White Inc VAT
ICEB/BS1245W	1220	465	534	1823	£790.00	£948.00
ICEB/BS1545W	1520	465	663	2263	£1,030.00	£1,236.00
ICEB/BS1560W	1520	615	883	3014	£1,206.00	£1,447.20
ICEB/BS1845W	1820	465	793	2707	£1,077.00	£1,292.40
ICEB/BS1860W	1820	615	1057	3608	£1,243.00	£1,491.60
ICEB/BS2045W	2020	465	881	3007	£1,125.00	£1,350.00

Please note: vertical models 1220mm have 1 towel bar, 1520mm, 1820mm & 2020mm have 2 bars.

Ice Bagno vertical will always be quoted with full towel bars; if you require short bars please specify at time of order.

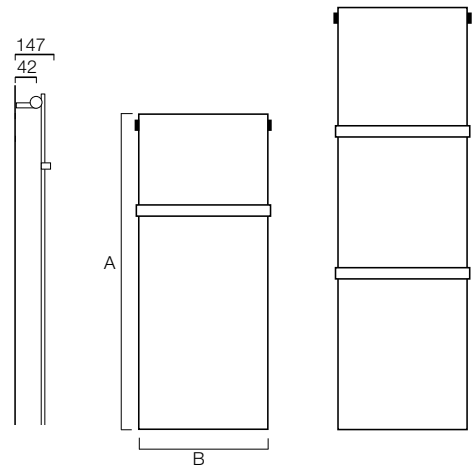

Ice Bagno vertical	Pipe centres left to right	Pipe centres from wall	Depth from wall
Ice Bagno vertical	width - 10mm + valves	42mm	147mm

Automatic bleed valve included with these radiators

Underneath Connections	Ex VAT	Inc VAT
B2CONN	£91.00	£109.20

Underneath Connections must be specified at time of order.

B2 pipe centres = width - 75mm

Ice Bagno Horizontal Polished Stainless Steel

Model	Height A (mm)	Width B (mm)	Watts Δt 50°C	Btu's Δt 50°C	Polished Stainless Steel Ex VAT	Polished Stainless Steel Inc VAT
ICEBH4512S	465	1220	416	1420	£1,797.00	£2,156.40
ICEBH6012S	615	1220	556	1898	£1,988.00	£2,385.60

Ice Bagno Horizontal Matt White

Model	Height A (mm)	Width B (mm)	Watts Δt 50°C	Btu's Δt 50°C	White Ex VAT	White Inc VAT
ICEBH4512W	465	1220	555	1894	£869.00	£1,042.80
ICEBH6012W	615	1220	741	2529	£1,007.00	£1,208.40

Ice Bagno horizontal	Pipe centres left to right	Pipe centres from wall	Depth from wall
Ice Bagno horizontal	width - 60mm	32mm - 42mm	135mm - 145mm

Automatic bleed valve included with these radiators



Volcano Towel Rail shown on page 70



Model	Height A (mm)	Width B (mm)	Watts Δt 50°C	Btu's Δt 50°C	White Ex VAT	Colours Ex VAT	White Inc VAT	Colours Inc VAT
VOTRS7248	720	486	420	1433	£322.00	£402.00	£386.40	£482.40
VOTRS7258	720	586	530	1809	£373.00	£466.00	£447.60	£559.20
VOTRS7274	720	746	639	2181	£411.00	£513.00	£493.20	£615.60
VOTRS1148	1160	486	693	2365	£428.00	£534.00	£513.60	£640.80
VOTRS1158	1160	586	814	2778	£475.00	£593.00	£570.00	£711.60
VOTRS1174	1160	746	997	3403	£517.00	£647.00	£620.40	£776.40
VOTRS1448	1440	486	860	2935	£504.00	£630.00	£604.80	£756.00
VOTRS1458	1440	586	1015	3464	£551.00	£689.00	£661.20	£826.80
VOTRS1474	1440	746	1250	4266	£639.00	£800.00	£766.80	£960.00
VOTRS1748	1720	486	1032	3522	£704.00	£880.00	£844.80	£1,056.00
VOTRS1758	1720	586	1218	4157	£746.00	£932.00	£895.20	£1,118.40
VOTRS1774	1720	746	1500	5120	£793.00	£991.00	£951.60	£1,189.20

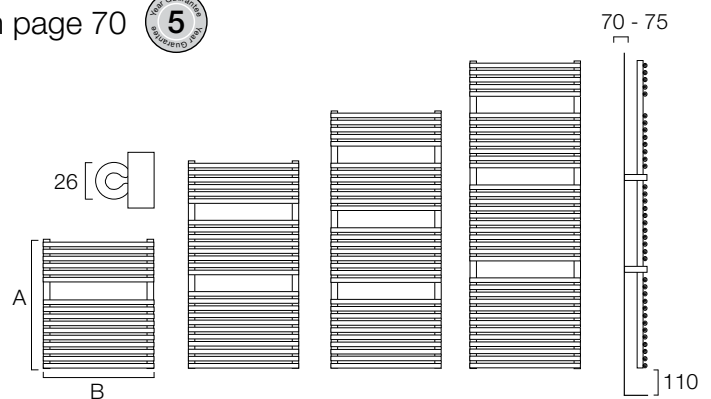

Volcano Towel Rail	Pipe centres left to right	Pipe centres from wall	Depth from wall
Volcano Towel Rail	width - 35mm	70mm - 75mm	107mm - 112mm

Automatic bleed valve included with these towel rails



180 A shown on page 70



All stocked radiators have prices listed in purple and will be delivered in 3 - 5 working days.

Model	Height A (mm)	Width B (mm)	Watts Δt 50°C	Btu's Δt 50°C	White Ex VAT	Colours Ex VAT	White Inc VAT	Colours Inc VAT
1801234	1250	340	391	1334	£224.00	£290.00	£268.80	£348.00
1801434	1450	340	497	1696	£259.00	£337.00	£310.80	£404.40

180 A Chrome

Model	Height A (mm)	Width B (mm)	Watts Δt 50°C	Btu's Δt 50°C	Chrome Ex VAT	Chrome Inc VAT
1801234C	1250	340	254	867	£407.00	£488.40
1801434C	1450	340	323	1102	£467.00	£560.40

180 A	Pipe centres left to right	Pipe centres from wall	Depth from wall
180 A	310mm	45mm	225mm

Automatic bleed valve included with these towel rails

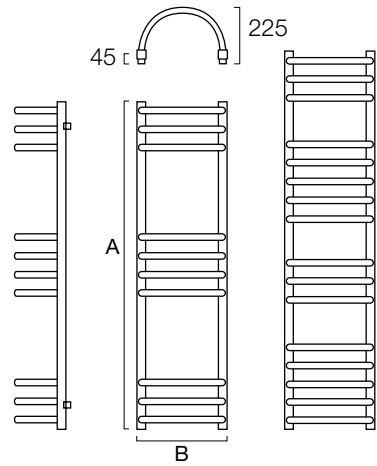

BDO Trim shown on page 71



Model	Height A (mm)	Width B (mm)	Watts Δt 50°C	Btu's Δt 50°C	White Ex VAT	Colours Ex VAT	White Inc VAT	Colours Inc VAT
BDOTS3612	368	1200	534	1823	£526.00	£657.00	£631.20	£788.40
BDOTS3614	368	1400	619	2113	£556.00	£695.00	£667.20	£834.00
BDOTS3616	368	1600	712	2430	£587.00	£734.00	£704.40	£880.80
BDOTS5812	584	1200	801	2734	£647.00	£809.00	£776.40	£970.80
BDOTS5814	584	1400	929	3171	£686.00	£857.00	£823.20	£1,028.40
BDOTS5816	584	1600	1068	3645	£724.00	£905.00	£868.80	£1,086.00

Towel Rail	Pipe centres left to right	Pipe centres from wall	Depth from wall
BDO Trim	width - 40mm	63mm - 77mm	100mm

Automatic bleed valve included with these towel rails

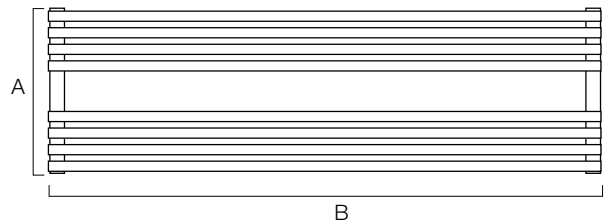
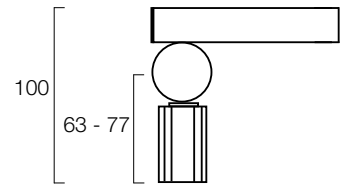

Tornado Towel Rail shown on page 72



Model	Height A (mm)	Width B (mm)	Watts Δt 50°C	Btu's Δt 50°C	White Ex VAT	Colours Ex VAT	White Inc VAT	Colours Inc VAT
TOTRS7248	750	486	567	1935	£355.00	£444.00	£426.00	£532.80
TOTRS7258	750	586	680	2321	£370.00	£462.00	£444.00	£554.40
TOTRS7274	750	746	813	2775	£414.00	£518.00	£496.80	£621.60
TOTRS1148	1125	486	718	2451	£419.00	£523.00	£502.80	£627.60
TOTRS1158	1125	586	860	2935	£438.00	£548.00	£525.60	£657.60
TOTRS1174	1125	746	1096	3741	£477.00	£596.00	£572.40	£715.20
TOTRS1448	1425	486	865	2952	£550.00	£688.00	£660.00	£825.60
TOTRS1458	1425	586	1048	3577	£574.00	£718.00	£688.80	£861.60
TOTRS1474	1425	746	1279	4365	£609.00	£761.00	£730.80	£913.20
TOTRS1748	1725	486	1169	3990	£648.00	£810.00	£777.60	£972.00
TOTRS1758	1725	586	1395	4761	£681.00	£853.00	£817.20	£1,023.60
TOTRS1774	1725	746	1692	5775	£731.00	£914.00	£877.20	£1,096.80

Tornado Towel Rail	Pipe centres left to right	Pipe centres from wall	Depth from wall
Tornado Towel Rail	width - 35mm	70mm - 75mm	103mm - 108mm

Automatic bleed valve included with these towel rails

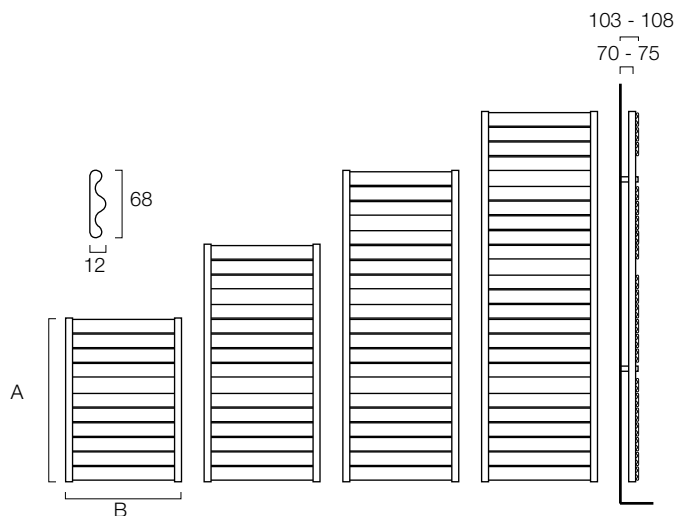

Trim Towel Rail

shown on page 72



All stocked radiators have prices listed in purple and will be delivered in 3 - 5 working days.

Model	Height A (mm)	Width B (mm)	Watts Δt 50°C	Btu's Δt 50°C	White Ex VAT	Colours Ex VAT	White Inc VAT	Colours Inc VAT
TRIMTR8040	800	400	523	1785	£522.00	£652.00	£626.40	£782.40
TRIMTR8050	800	500	653	2230	£533.00	£666.00	£639.60	£799.20
TRIMTR8060	800	600	785	2679	£545.00	£681.00	£654.00	£817.20
TRIMTR1140	1160	400	662	2260	£570.00	£713.00	£684.00	£855.60
TRIMTR1150	1160	500	828	2825	£586.00	£733.00	£703.20	£879.60
TRIMTR1160	1160	600	993	3390	£601.00	£752.00	£721.20	£902.40
TRIMTR1540	1520	400	910	3107	£631.00	£789.00	£757.20	£946.80
TRIMTR1550	1520	500	1138	3884	£651.00	£814.00	£781.20	£976.80
TRIMTR1560	1520	600	1366	4661	£672.00	£840.00	£806.40	£1,008.00
TRIMTR1840	1880	400	1073	3663	£697.00	£872.00	£836.40	£1,046.40
TRIMTR1850	1880	500	1342	4581	£721.00	£902.00	£865.20	£1,082.40
TRIMTR1860	1880	600	1610	5495	£746.00	£932.00	£895.20	£1,118.40

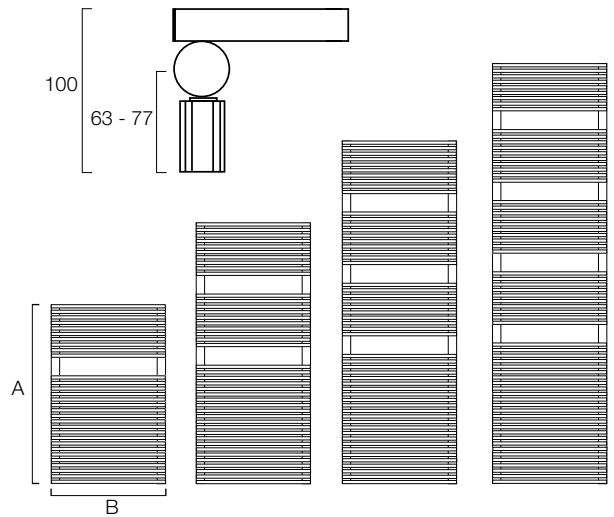

Towel Rail	Pipe centres left to right	Pipe centres from wall
Trim Towel Rail	width - 30mm	63mm - 77mm
Automatic bleed valve included with these towel rails		

BDO 25

shown on page 73



Model	Height A (mm)	Width B (mm)	Watts Δt 50°C	Btu's Δt 50°C	White Ex VAT	Colours Ex VAT	White Inc VAT	Colours Inc VAT
BDO25S3612	368	1200	479	1635	£192.00	£240.00	£230.40	£288.00
BDO25S3614	368	1400	559	1908	£213.00	£267.00	£255.60	£320.40
BDO25S3616	368	1600	639	2181	£233.00	£291.00	£279.60	£349.20
BDO25S5812	584	1200	719	2454	£267.00	£333.00	£320.40	£399.60
BDO25S5814	584	1400	838	2860	£289.00	£361.00	£346.80	£433.20
BDO25S5816	584	1600	958	3270	£311.00	£389.00	£373.20	£466.80

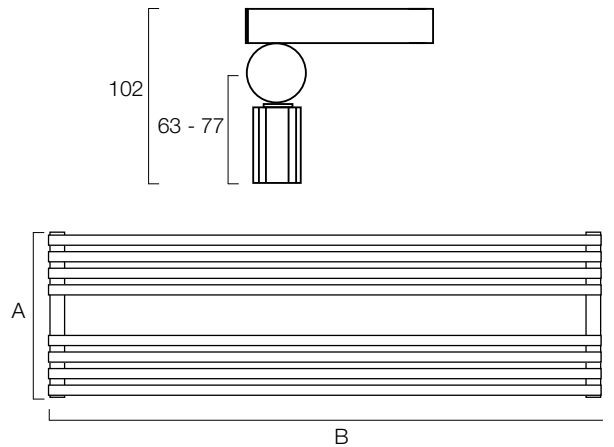

Towel Rail	Pipe centres left to right	Pipe centres from wall	Depth from wall
BDO 25	width - 40mm	63mm - 77mm	102mm
Automatic bleed valve included with these towel rails			

Bath 25

shown on page 74



Model	Height A (mm)	Width B (mm)	Watts Δt 50°C	Btu's Δt 50°C	White Ex VAT	White Inc VAT
BA258043	800	435	379	1294	£217.00	£260.40
BA258048	800	485	421	1437	£226.00	£271.20
BA258058	800	585	504	1720	£247.00	£296.40
BA251143	1160	435	542	1850	£286.00	£343.20
BA251148	1160	485	600	2048	£295.00	£354.00
BA251158	1160	585	717	2447	£319.00	£382.80
BA251543	1520	435	697	2379	£349.00	£418.80
BA251548	1520	485	772	2635	£355.00	£426.00
BA251558	1520	585	922	3147	£385.00	£462.00
BA251843	1880	435	837	2857	£391.00	£469.20
BA251848	1880	485	919	3137	£400.00	£480.00
BA251858	1880	585	1097	3744	£415.00	£498.00

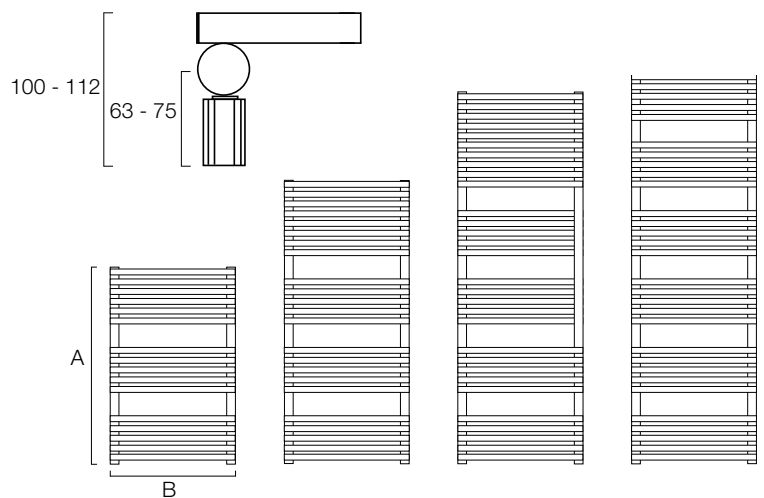

Towel Rail	Pipe centres left to right	Pipe centres from wall	Depth from wall
Bath 25	width - 40mm	63mm - 75mm	100mm - 112mm
Automatic bleed valve included with these towel rails			



BD 13 shown on page 74



All stocked radiators have prices listed in purple and will be delivered in 3 - 5 working days.

BD 13 Single

Model	Height A (mm)	Width B (mm)	Watts Δt 50°C	Btu's Δt 50°C	White Ex VAT	Colours Ex VAT	White Inc VAT	Colours Inc VAT
BD13S8040	800	400	388	1322	£344.00	£430.00	£412.80	£516.00
BD13S8050	800	500	484	1650	£365.00	£456.00	£438.00	£547.20
BD13S8060	800	600	579	1973	£381.00	£477.00	£457.20	£572.40
BD13S1140	1160	400	541	1844	£545.00	£682.00	£654.00	£818.40
BD13S1150	1160	500	673	2296	£553.00	£692.00	£663.60	£830.40
BD13S1160	1160	600	805	2745	£570.00	£712.00	£684.00	£854.40
BD13S1540	1520	400	690	2351	£631.00	£789.00	£757.20	£946.80
BD13S1550	1520	500	858	2926	£634.00	£793.00	£760.80	£951.60
BD13S1560	1520	600	1026	3500	£650.00	£813.00	£780.00	£975.60

BD 13 Double

Model	Height A (mm)	Width B (mm)	Watts Δt 50°C	Btu's Δt 50°C	White Ex VAT	Colours Ex VAT	White Inc VAT	Colours Inc VAT
BD13D8040	800	400	610	2080	£748.00	£935.00	£897.60	£1,122.00
BD13D8050	800	500	761	2596	£753.00	£941.00	£903.60	£1,129.20
BD13D8060	800	600	912	3108	£829.00	£1,036.00	£994.80	£1,243.20
BD13D1140	1160	400	818	2790	£1,056.00	£1,320.00	£1,267.20	£1,584.00
BD13D1150	1160	500	1021	3483	£1,062.00	£1,328.00	£1,274.40	£1,593.60
BD13D1160	1160	600	1225	4176	£1,169.00	£1,461.00	£1,402.80	£1,753.20
BD13D1540	1520	400	1005	3426	£1,220.00	£1,525.00	£1,464.00	£1,830.00
BD13D1550	1520	500	1253	4273	£1,230.00	£1,537.00	£1,476.00	£1,844.40
BD13D1560	1520	600	1504	5129	£1,350.00	£1,688.00	£1,620.00	£2,025.60

BD 13 Single Chrome / Nickel

Model	Height A (mm)	Width B (mm)	Watts Δt 50°C	Btu's Δt 50°C	Chrome/Nickel Ex VAT	Chrome/Nickel Inc VAT
BD13S8040C/N	800	400	260	886	£861.00	£1,033.20
BD13S8050C/N	800	500	324	1105	£914.00	£1,096.80
BD13S8060C/N	800	600	388	1322	£1,009.00	£1,210.80
BD13S1140C/N	1160	400	362	1236	£1,201.00	£1,441.20
BD13S1150C/N	1160	500	451	1538	£1,218.00	£1,461.60
BD13S1160C/N	1160	600	539	1839	£1,339.00	£1,606.80
BD13S1540C/N	1520	400	462	1575	£1,387.00	£1,664.40
BD13S1550C/N	1520	500	575	1961	£1,396.00	£1,675.20
BD13S1560C/N	1520	600	668	2345	£1,537.00	£1,844.40

BD 13	Pipe centres left to right	Pipe centres from wall
BD 13 Single	width - 40mm	63mm - 77mm
BD 13 Double	width - 40mm	54mm

Automatic bleed valve included with these towel rails

single

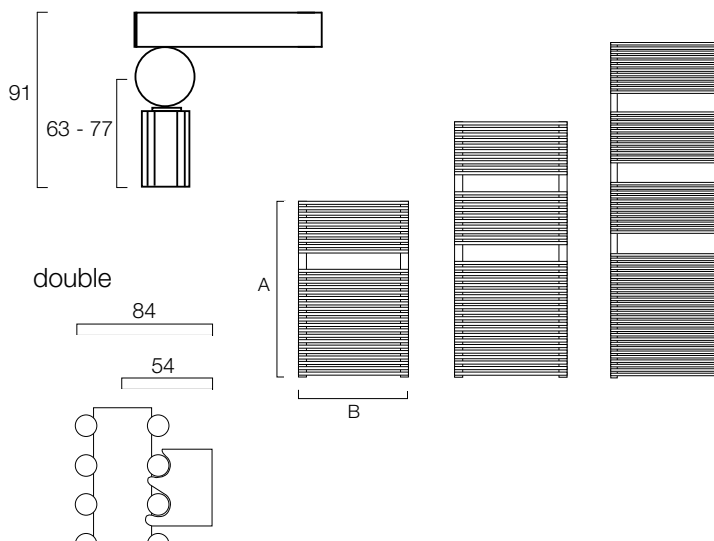

Dexter shown on page 75



Model	Height A (mm)	Width B (mm)	Watts Δt 50°C	Btu's Δt 50°C	White Ex VAT	Colours Ex VAT	White Inc VAT	Colours Inc VAT
DEXT8640	860	400	382	1304	£217.00	£282.00	£260.40	£338.40
DEXT8650	860	500	434	1481	£226.00	£293.00	£271.20	£351.60
DEXT8660	860	600	486	1659	£234.00	£305.00	£280.80	£366.00
DEXT1240	1220	400	511	1744	£278.00	£361.00	£333.60	£433.20
DEXT1250	1220	500	599	2044	£289.00	£376.00	£346.80	£451.20
DEXT1260	1220	600	670	2287	£298.00	£387.00	£357.60	£464.40
DEXT1740	1760	400	733	2502	£399.00	£519.00	£478.80	£622.80
DEXT1750	1760	500	862	2942	£415.00	£540.00	£498.00	£648.00
DEXT1760	1760	600	965	3294	£433.00	£562.00	£519.60	£674.40

Dexter Chrome

Model	Height A (mm)	Width B (mm)	Watts Δt 50°C	Btu's Δt 50°C	Chrome Ex VAT	Chrome Inc VAT
DEXT8640C	860	400	269	918	£677.00	£812.40
DEXT8650C	860	500	302	1031	£708.00	£849.60
DEXT8660C	860	600	342	1167	£737.00	£884.40
DEXT1240C	1220	400	357	1218	£886.00	£1,063.20
DEXT1250C	1220	500	414	1413	£929.00	£1,114.80
DEXT1260C	1220	600	470	1604	£970.00	£1,164.00

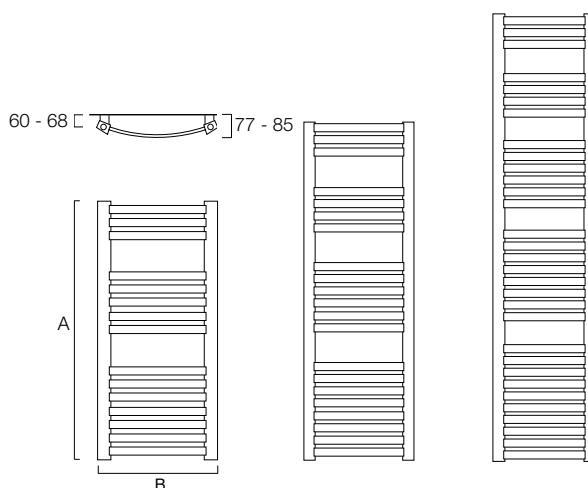

Dexter	Pipe centres left to right	Pipe centres from wall	Depth from wall
Dexter	width - 43mm	60mm - 68mm	77mm - 85mm

Automatic bleed valve included with these towel rails

Non stock towel rails are bespoke & made to order. Delivery times may be extended during factory holiday closures in Jul/Aug & Dec. Delivery times will be confirmed at time of order.

Poll shown on page 77



All stocked radiators have prices listed in purple and will be delivered in 3 - 5 working days.

Model	Height A (mm)	Width B (mm)	Watts Δt 50°C	Btu's Δt 50°C	White Ex VAT	Colours Ex VAT	White Inc VAT	Colours Inc VAT
POLL5345	530	450	353	1205	£175.00	£229.00	£210.00	£274.80
POLL5350	530	500	383	1307	£180.00	£234.00	£216.00	£280.80
POLL5360	530	600	444	1515	£187.00	£243.00	£224.40	£291.60
POLL5370	530	700	503	1717	£191.00	£249.00	£229.20	£298.80
POLL1045	1055	450	634	2164	£222.00	£289.00	£266.40	£346.80
POLL1050	1055	500	680	2321	£229.00	£298.00	£274.80	£357.60
POLL1060	1055	600	802	2737	£243.00	£315.00	£291.60	£378.00
POLL1070	1055	700	905	3089	£255.00	£332.00	£306.00	£398.40
POLL1080	1055	800	1008	3440	£267.00	£348.00	£320.40	£417.60
POLL1445	1480	450	868	2962	£309.00	£401.00	£370.80	£481.20
POLL1450	1480	500	941	3212	£314.00	£408.00	£376.80	£489.60
POLL1460	1480	600	1086	3707	£322.00	£420.00	£386.40	£504.00
POLL1470	1480	700	1238	4225	£334.00	£435.00	£400.80	£522.00
POLL1480	1480	800	1372	4683	£345.00	£449.00	£414.00	£538.80

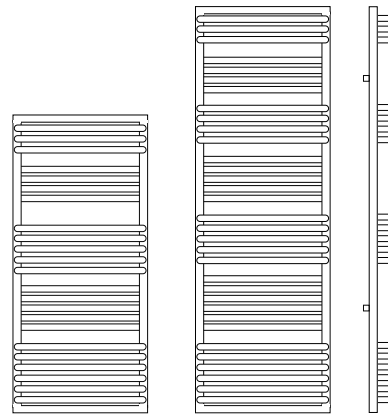
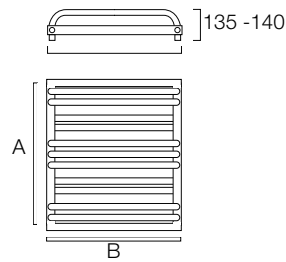

Poll	Pipe centres left to right	Pipe centres from wall
Poll	width - 30mm	57mm - 65mm
Automatic bleed valve included with these towel rails		

Poll Kitchen shown on page 76



Model	Height A (mm)	Width B (mm)	Element Size in Watts	White Ex VAT	Silver Ex VAT	Black Ex VAT	White Inc VAT	Silver Inc VAT	Black Inc VAT
POLE2345	230	450	120	£151.00	£194.00	£194.00	£181.20	£232.80	£232.80

The Poll Kitchen is rated IP 54.

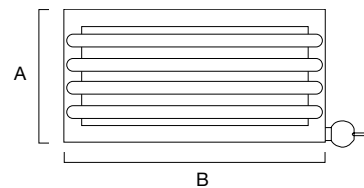
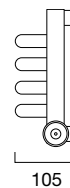

Poll Chrome shown on page 76



Model	Height A (mm)	Width B (mm)	Watts Δt 50°C	Btu's Δt 50°C	Chrome Ex VAT	Chrome Inc VAT
POLL5345C	530	450	149	509	£392.00	£470.40
POLL5350C	530	500	161	549	£401.00	£481.20
POLL5360C	530	600	190	648	£423.00	£507.60
POLL5370C	530	700	219	747	£447.00	£536.40
POLL1045C	1055	450	335	1143	£625.00	£750.00
POLL1050C	1055	500	370	1263	£645.00	£774.00
POLL1060C	1055	600	428	1461	£688.00	£825.60
POLL1070C	1055	700	486	1659	£732.00	£878.40
POLL1080C	1055	800	559	1908	£771.00	£925.20

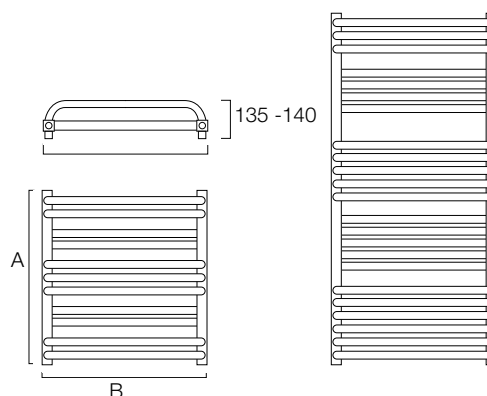

The Poll Chrome is different to the Poll as it does not have a top and bottom collector; this is so it can be finished in a deep and lustrous chrome.

Poll Chrome	Pipe centres left to right	Pipe centres from wall
Poll Chrome	width - 30mm	57mm - 65mm
Automatic bleed valve included with these towel rails		



Lupin White

shown on page 78



All stocked radiators have prices listed in purple and will be delivered in 3 - 5 working days.

Model	Height A (mm)	Width B (mm)	Watts Δt 50°C	Btu's Δt 50°C	White Ex VAT	White Inc VAT
LUPI9540W	950	400	408	1393	£103.00	£123.60
LUPI9550W	950	500	480	1639	£105.00	£126.00
LUPI9560W	950	600	565	1928	£108.00	£129.60
LUPI1340W	1300	400	538	1837	£123.00	£147.60
LUPI1350W	1300	500	633	2161	£132.00	£158.40
LUPI1360W	1300	600	745	2542	£140.00	£168.00
LUPI1640W	1650	400	697	2380	£134.00	£160.80
LUPI1650W	1650	500	820	2800	£146.00	£175.20
LUPI1660W	1650	600	965	3293	£158.00	£189.60
LUPI1840W	1817	400	784	2675	£159.00	£190.80
LUPI1850W	1817	500	922	3148	£166.00	£199.20
LUPI1860W	1817	600	1085	3702	£172.00	£206.40

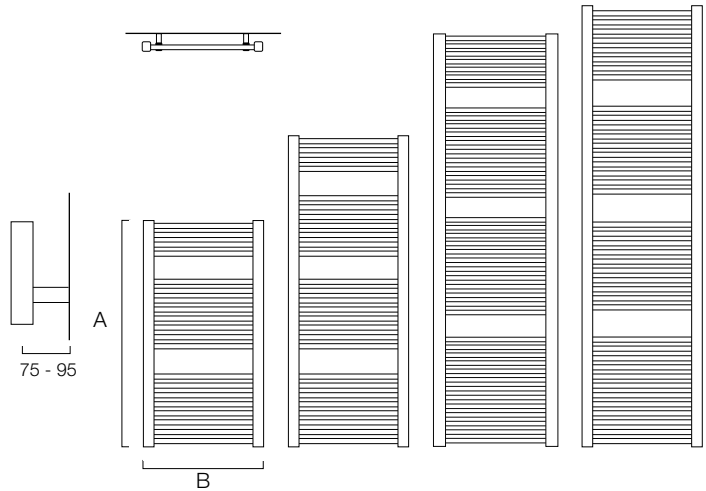

Lupin Chrome

shown on page 78



Model	Height A (mm)	Width B (mm)	Watts Δt 50°C	Btu's Δt 50°C	Chrome Ex VAT	Chrome Inc VAT
LUPI9540C	950	400	286	976	£318.00	£381.60
LUPI9550C	950	500	337	1149	£326.00	£391.20
LUPI9560C	950	600	396	1351	£333.00	£399.60
LUPI1340C	1300	400	377	1287	£395.00	£474.00
LUPI1350C	1300	500	444	1514	£406.00	£487.20
LUPI1360C	1300	600	522	1781	£417.00	£500.40
LUPI1640C	1650	400	488	1667	£467.00	£560.40
LUPI1650C	1650	500	575	1961	£479.00	£574.80
LUPI1660C	1650	600	676	2307	£490.00	£588.00
LUPI1840C	1817	400	615	2100	£549.00	£658.80
LUPI1850C	1817	500	724	2471	£561.00	£673.20
LUPI1860C	1817	600	825	2593	£561.00	£673.20

Lupin	Pipe centres left to right	Pipe centres from wall
Lupin	width - 50mm	75mm - 95mm

Automatic bleed valve included with these towel rails

Poppy White

shown on page 79



Model	Height A (mm)	Width B (mm)	Watts Δt 50°C	Btu's Δt 50°C	White Ex VAT	White Inc VAT
POPP9540W	950	400	426	1455	£116.00	£139.20
POPP9550W	950	500	502	1712	£119.00	£142.80
POPP9560W	950	600	590	2013	£121.00	£145.20
POPP1340W	1300	400	560	1911	£137.00	£164.40
POPP1350W	1300	500	659	2248	£142.00	£170.40
POPP1360W	1300	600	775	2644	£146.00	£175.20
POPP1640W	1650	400	723	2466	£163.00	£195.60
POPP1650W	1650	500	850	2901	£168.00	£201.60
POPP1660W	1650	600	1000	3412	£175.00	£210.00
POPP1840W	1817	400	809	2762	£177.00	£212.40
POPP1850W	1817	500	952	3249	£183.00	£219.60
POPP1860W	1817	600	1120	3821	£190.00	£228.00

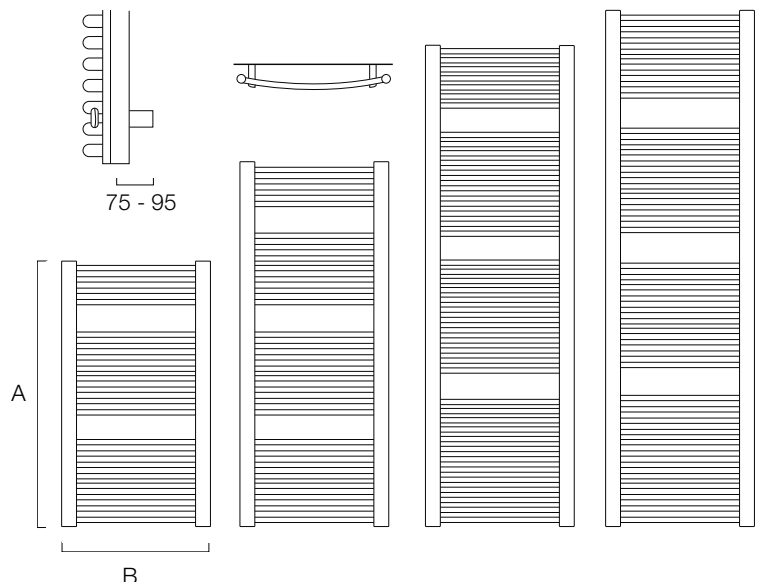

Poppy Chrome

shown on page 79



All stocked radiators have prices listed in purple and will be delivered in 3 - 5 working days.

Model	Height A (mm)	Width B (mm)	Watts Δt 50°C	Btu's Δt 50°C	Chrome Ex VAT	Chrome Inc VAT
POPP9540C	950	400	298	1018	£352.00	£422.40
POPP9550C	950	500	351	1198	£359.00	£430.80
POPP9560C	950	600	413	1409	£367.00	£440.40
POPP1340C	1300	400	392	1339	£424.00	£508.80
POPP1350C	1300	500	462	1575	£434.00	£520.80
POPP1360C	1300	600	543	1853	£444.00	£532.80
POPP1640C	1650	400	506	1726	£502.00	£602.40
POPP1650C	1650	500	595	2031	£513.00	£615.60
POPP1660C	1650	600	700	2389	£523.00	£627.60
POPP1840C	1817	400	566	1933	£574.00	£688.80
POPP1850C	1817	500	666	2274	£585.00	£702.00
POPP1860C	1817	600	784	2676	£598.00	£717.60

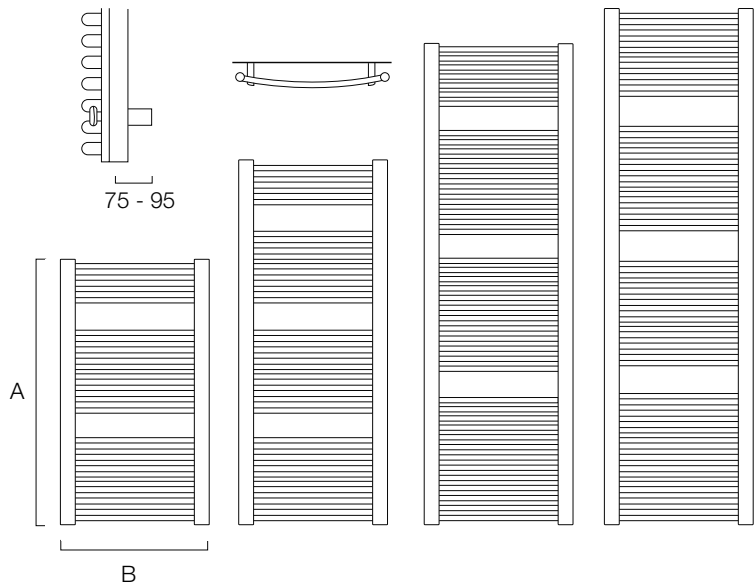

Poppy	Pipe centres left to right	Pipe centres from wall
Poppy	width - 50mm	75mm - 95mm

Automatic bleed valve included with these towel rails

Picchio Towel Rail

shown on page 80



Model	Height A (mm)	Width B (mm)	Watts Δt 50°C	Btu's Δt 50°C	White Ex VAT	Colours Ex VAT	White Inc VAT	Colours Inc VAT
PICCTR8251	826	510	425	1451	£290.00	£363.00	£348.00	£435.60
PICCTR8261	826	610	513	1751	£304.00	£380.00	£364.80	£456.00
PICCTR8276	826	760	644	2198	£336.00	£420.00	£403.20	£504.00
PICCTR1251	1201	510	611	2085	£342.00	£428.00	£410.40	£513.60
PICCTR1261	1201	610	727	2481	£358.00	£448.00	£429.60	£537.60
PICCTR1276	1201	760	899	3068	£390.00	£488.00	£468.00	£585.60
PICCTR1851	1876	510	904	3085	£610.00	£762.00	£732.00	£914.40
PICCTR1861	1876	610	1073	3662	£642.00	£802.00	£770.40	£962.40
PICCTR1876	1876	760	1326	4526	£688.00	£860.00	£825.60	£1,032.00

Piccho Towel Rail Chrome

Model	Height A (mm)	Width B (mm)	Watts Δt 50°C	Btu's Δt 50°C	Chrome Ex VAT	Chrome Inc VAT
PICCTR8251C	826	510	319	1089	£683.00	£819.60
PICCTR8261C	826	610	385	1314	£715.00	£858.00
PICCTR8276C	826	760	483	1648	£791.00	£949.20
PICCTR1251C	1201	510	458	1563	£804.00	£964.80
PICCTR1261C	1201	610	545	1860	£842.00	£1,010.40
PICCTR1276C	1201	760	674	2300	£918.00	£1,101.60

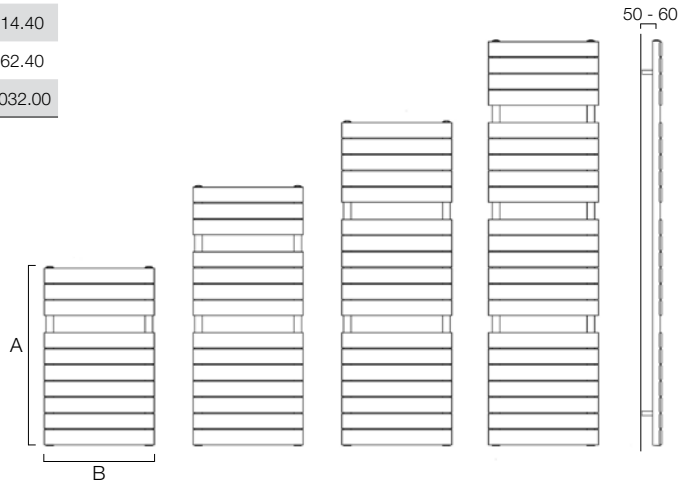

Picchio Towel Rail	Pipe centres left to right	Pipe centres from wall
Picchio Towel Rail	width - 35mm	50mm - 60mm

Automatic bleed valve included with these towel rails



Camino Towel Rail

shown on page 80



All stocked radiators have prices listed in purple and will be delivered in 3 - 5 working days.

Model	Height A (mm)	Width B (mm)	Watts Δt 50°C	Btu's Δt 50°C	White Ex VAT	Colours Ex VAT	White Inc VAT	Colours Inc VAT
CAMITR8451	847	510	459	1567	£445.00	£578.00	£534.00	£693.60
CAMITR8476	847	760	695	2372	£515.00	£670.00	£618.00	£804.00
CAMITR1251	1207	510	653	2229	£525.00	£682.00	£630.00	£818.40
CAMITR1276	1207	760	962	3283	£598.00	£778.00	£717.60	£933.60
CAMITR1451	1487	510	793	2707	£690.00	£898.00	£828.00	£1,077.60
CAMITR1461	1487	610	940	3208	£721.00	£937.00	£865.20	£1,124.40
CAMITR1476	1487	760	1160	3959	£764.00	£993.00	£916.80	£1,191.60
CAMITR1851	1887	510	967	3300	£813.00	£1,057.00	£975.60	£1,268.40
CAMITR1861	1887	610	1148	3918	£856.00	£1,113.00	£1,027.20	£1,335.60
CAMITR1876	1887	760	1419	4843	£918.00	£1,193.00	£1,101.60	£1,431.60

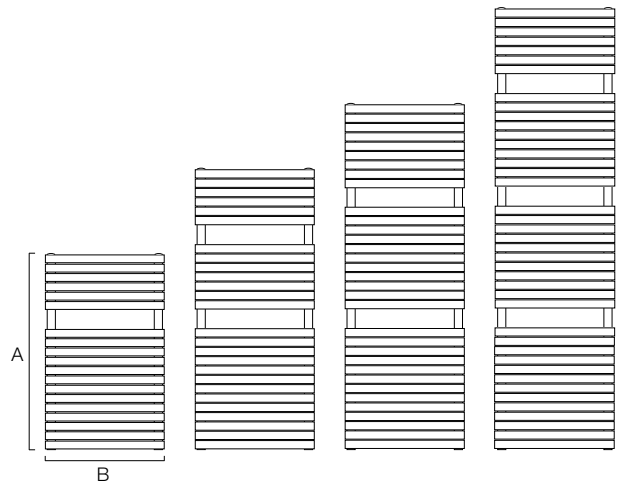

Camino Towel Rail	Pipe centres left to right	Pipe centres from wall	Depth from wall
Camino Towel Rail	width - 50mm	72mm - 82mm	95mm - 105mm

Automatic bleed valve included with these towel rails

Iris

shown on page 81



Model	Height A (mm)	Width B (mm)	Watts Δt 50°C	Btu's Δt 50°C	Stainless Steel Ex VAT	Stainless Steel Inc VAT
IRIS8052S	805	520	454	1552	£300.00	£360.00
IRIS8110S	810	1000	778	2659	£366.00	£439.20
IRIS1252S	1295	520	697	2382	£393.00	£471.60
IRIS1336S	1300	360	638	2183	£371.00	£445.20

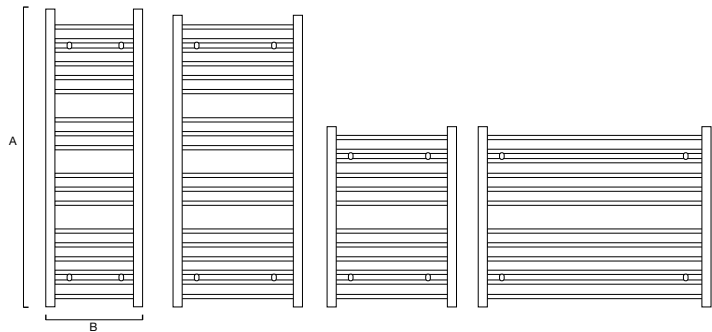

Iris	Pipe centres left to right	Pipe centres from wall
Iris	width - 30mm	65mm - 85mm

Automatic bleed valve included with these towel rails

Sail

shown on page 82



Model	Height A (mm)	Width B (mm)	Watts Δt 50°C	Btu's Δt 50°C	Stainless Steel Ex VAT	Stainless Steel Inc VAT
SAIL7065	700	650	370	1263	£639.00	£766.80
SAIL1265	1200	650	525	1792	£919.00	£1,102.80

Please specify Polished or Brushed finish at the time of order.

Sail	Pipe centres left to right	Pipe centres from wall	Distance from wall
Sail	160mm	55mm	140mm - 160mm

Automatic bleed valve included with these towel rails

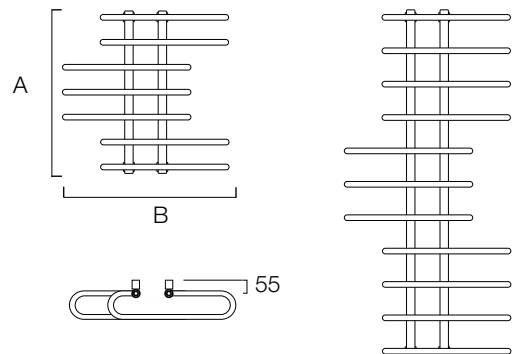

Mast shown on page 82



All stocked radiators have prices listed in purple and will be delivered in 3 - 5 working days.

Model	Height A (mm)	Width B (mm)	Watts Δt 50°C	Btu's Δt 50°C	Stainless Steel Ex VAT	Stainless Steel Inc VAT
MAST7050	700	500	370	1263	£639.00	£766.80
MAST1250	1200	500	525	1792	£919.00	£1,102.80

Please specify Polished or Brushed finish at the time of order.

Mast	Pipe centres left to right	Pipe centres from wall	Distance from wall
Mast	160mm	55mm	140mm - 160mm

Automatic bleed valve included with these towel rails

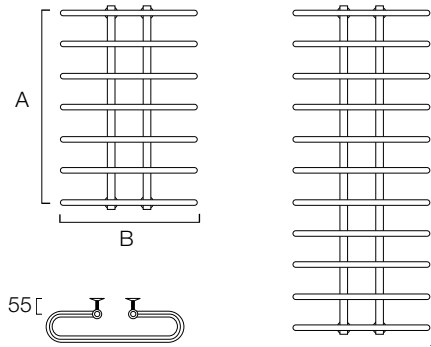

Sudbury shown on page 83



Model	Height A (mm)	Width B (mm)	Watts Δt 50°C	Btu's Δt 50°C	Chrome Ex VAT	Chrome Inc VAT
SUDB9550C	950	500	399	1362	£775.00	£930.00
SUDB9568C	950	685	562	1918	£825.00	£990.00

Sudbury	Pipe centres left to right	Maximum depth from wall
Sudbury	width - 237mm	240mm

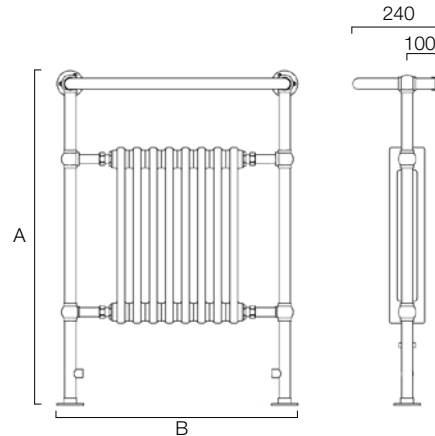

York shown on page 83



Model	Height A (mm)	Width B (mm)	Watts Δt 50°C	Btu's Δt 50°C	Chrome Ex VAT	Chrome Inc VAT
YORK1558C	1500	585	782	2669	£1,050.00	£1,260.00

York	Pipe centres left to right	Maximum depth from wall
York	width - 237mm	240mm

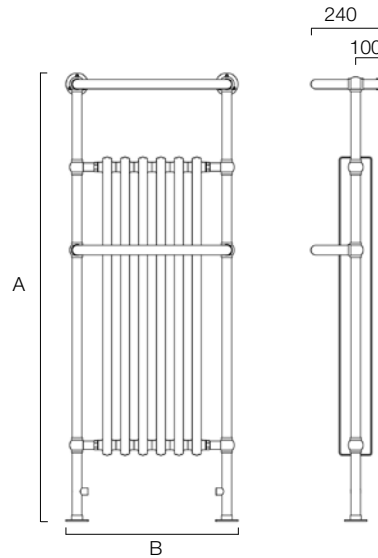

Chester shown on page 84



Model	Height A (mm)	Width B (mm)	Watts Δt 50°C	Btu's Δt 50°C	Chrome Ex VAT	Special Finish Ex VAT	Chrome Inc VAT	Special Finish Inc VAT
CHES7653	762	530	295	1007	£719.00	£1,006.00	£862.80	£1,207.20
CHES1053	1076	530	406	1386	£909.00	£1,272.00	£1,090.80	£1,526.40
CHES1353	1390	530	513	1751	£1,131.00	£1,584.00	£1,357.20	£1,900.80

Chester	Pipe centres left to right	Maximum depth from wall
Chester	470mm	125mm

Integral valves included with the Chester

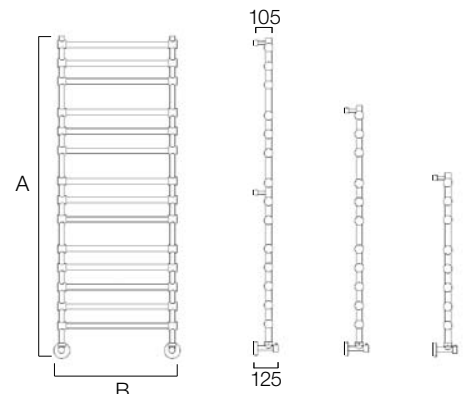

Arundel shown on page 84



All stocked radiators have prices listed in purple and will be delivered in 3 - 5 working days.

Model	Height A (mm)	Width B (mm)	Watts Δt 50°C	Btu's Δt 50°C	Chrome Ex VAT	Special Finish Ex VAT	Chrome Inc VAT	Special Finish Inc VAT
ARUN1060	1042	600	453	1544	£1,631.00	£2,402.00	£1,957.20	£2,882.40

Arundel	Pipe centres left to right	Maximum depth from wall
Arundel	550mm	295mm
Integral valves included with the Arundel		

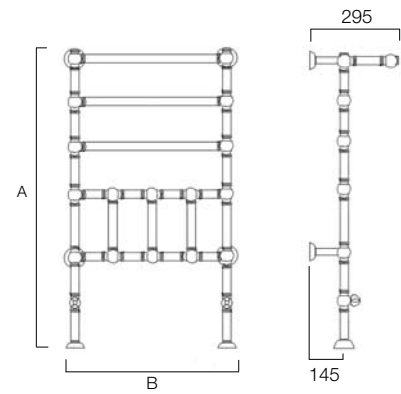

Traditional Ancona shown on page 85



Model	Height A (mm)	Width B (mm)	Watts Δt 50°C	Btu's Δt 50°C	Chrome Ex VAT	Special Finish Ex VAT	Chrome Inc VAT	Special Finish Inc VAT
TRAN9760	972	600	655	2233	£1,538.00	£2,000.00	£1,845.60	£2,400.00

Traditional Ancona	Pipe centres left to right	Maximum depth from wall
Traditional Ancona	550mm	295mm
Integral valves included with the Traditional Ancona		

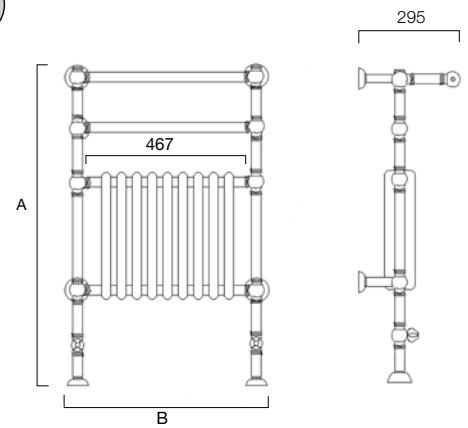

Panorama shown on page 86



Model	Height A (mm)	Width B (mm)	Watts Δt 50°C	Btu's Δt 50°C	Chrome Ex VAT	Special Finish Ex VAT	Chrome Inc VAT	Special Finish Inc VAT
PANO4412	440	1220	440	1501	£1,034.00	£1,448.00	£1,240.80	£1,737.60

Panorama	Pipe centres left to right	Maximum depth from wall
Panorama	1170mm	135mm
Integral valves included with the Panorama		

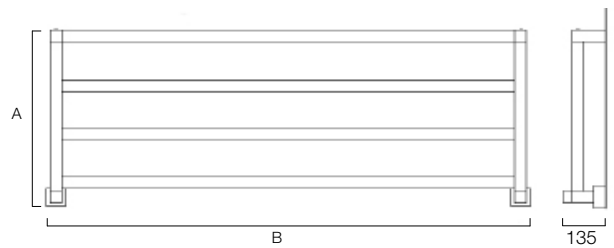

Cambridge shown on page 86



Model	Height A (mm)	Width B (mm)	Watts Δt 50°C	Btu's Δt 50°C	Chrome Ex VAT	Chrome Inc VAT
CAMB1135C	1135	350	322	1099	£959.00	£1,150.80
CAMB1150C	1135	500	352	1200	£1,072.00	£1,286.40
CAMB1180C	1135	800	382	1298	£1,211.00	£1,453.20

Please note; the width quoted is the width of the collectors, please allow an additional 200mm for the shelf latches.

Cambridge	Pipe centres left to right	Maximum depth from wall
Cambridge	width - 32mm	390mm
Integral valves included with the Cambridge		

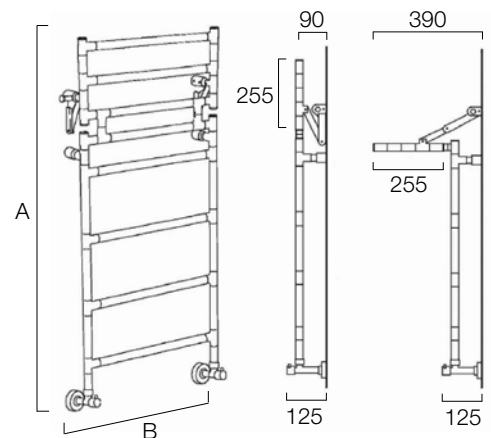

Non stock radiators are bespoke & made to order. Delivery times may be extended during factory holiday closures in Jul/Aug & Dec. Delivery times will be confirmed at time of order.

TRC Skirting Heating

shown on page 87



All stocked radiators have prices listed in purple and will be delivered in 3 - 5 working days.

Model	Height A (mm)	Width B (mm)	Watts Δt 50°C	Btu's Δt 50°C	Price Ex VAT	Price Inc VAT
TRSK500	179	500	280	956	£82.00	£98.40
TRSK100	179	1000	561	1914	£157.00	£188.40
TRSK150	179	1500	841	2870	£227.00	£272.40
TRSK200	179	2000	1121	3827	£299.00	£358.80
TRSKCS100	1000 casing only				£71.00	£85.20
TRSKVWLH	left hand valve box/end cap kit				£42.00	£50.40
TRSKVVRH	right hand valve box/end cap kit				£42.00	£50.40
TRSKVCC	centre valve cover				£21.00	£25.20
TRSKIN90	internal 90 corner				£21.00	£25.20
TRSKEX90	external 90 corner				£21.00	£25.20
TRSKIN135	internal 135 corner				£21.00	£25.20
TRSKEX135	external 135 corner				£21.00	£25.20

TRC Skirting Heating Guide

1. Work out your required heat output. For a more detailed explanation please see pages 160 - 161 or visit our website at www.theradiatorcompany.co.uk.
2. Decide which walls are best suited to the positioning of the skirting elements in relationship to your existing or planned pipe-work.
3. Measure the length of walls where the lengths are to be fitted.
(Please note it is not necessary to run the elements along the complete wall).
4. Use a combination of the various lengths available to provide the required heat output with a minimum number of joints. A 1000mm casing only length, suitable for cutting to size, is also available for making good where required. Use corners as required.
5. When fitting Thermostatic Radiator Valves leave sufficient distances between the end valve box and the wall to allow air movement.
6. Allow sufficient distances from room corners to fit corner attachments.

Please Note:

Joining strips are supplied with all skirting lengths ordered, 1 per length.

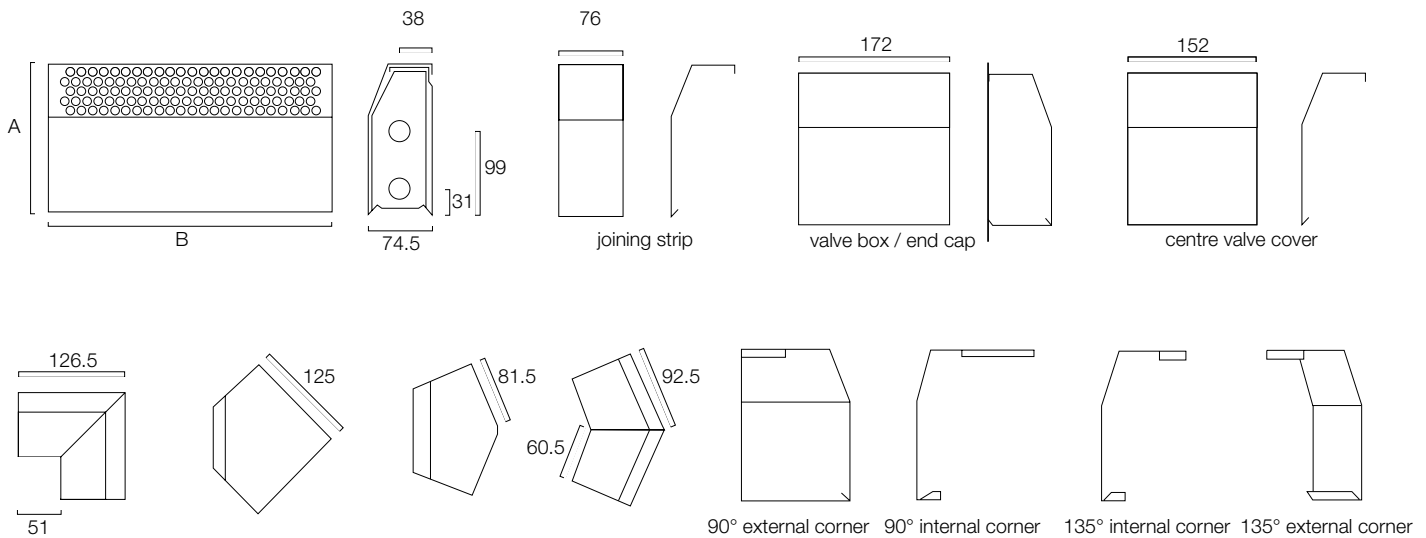

Important Note:

Valves are not supplied with TRC Skirting Heating. When fitting Thermostatic valves the valve head will protrude from the side of the valve box. Motorised or regular valves can be concealed within the valve box. TRC Skirting Heating uses 22mm UK connections. If fitting straight runs of 4 metres or longer we recommend that expansion joints are used. These are readily available from heating merchants.



Mini shown on page 88



130mm deep

Model	Height A (mm)	Width B (mm)	Depth C (mm)	Watts Δt 50°C	Btu's Δt 50°C	White Ex VAT	Colours Ex VAT	White Inc VAT	Colours Inc VAT
MINI1H6013	130	600	130	385	1314	£298.00	£339.00	£357.60	£406.80
MINI1H8013	130	800	130	514	1754	£326.00	£373.00	£391.20	£447.60
MINI1H1013	130	1000	130	642	2191	£359.00	£413.00	£430.80	£495.60
MINI1H1213	130	1200	130	770	2628	£404.00	£466.00	£484.80	£559.20
MINI1H1413	130	1400	130	899	3068	£428.00	£496.00	£513.60	£595.20
MINI1H1613	130	1600	130	1027	3505	£455.00	£527.00	£546.00	£632.40
MINI1H1813	130	1800	130	1156	3945	£469.00	£482.00	£562.80	£578.40
MINI1H2013	130	2000	130	1284	4382	£512.00	£596.00	£614.40	£715.20
MINI1H2213	130	2200	130	1412	4819	£538.00	£628.00	£645.60	£753.60
MINI1H2413	130	2400	130	1541	5259	£568.00	£664.00	£681.60	£796.80
MINI1H2613	130	2600	130	1669	5696	£602.00	£704.00	£722.40	£844.80
MINI2H6013	200	600	130	450	1536	£318.00	£363.00	£381.60	£435.60
MINI2H8013	200	800	130	600	2048	£350.00	£402.00	£420.00	£482.40
MINI2H1013	200	1000	130	749	2566	£387.00	£446.00	£464.40	£535.20
MINI2H1213	200	1200	130	899	3068	£438.00	£507.00	£525.60	£608.40
MINI2H1413	200	1400	130	1049	3580	£464.00	£538.00	£556.80	£645.60
MINI2H1613	200	1600	130	1199	4092	£491.00	£571.00	£589.20	£685.20
MINI2H1813	200	1800	130	1349	4604	£522.00	£608.00	£626.40	£729.60
MINI2H2013	200	2000	130	1499	5116	£553.00	£646.00	£663.60	£775.20
MINI2H2213	200	2200	130	1649	5628	£583.00	£681.00	£699.60	£817.20
MINI2H2413	200	2400	130	1799	6140	£616.00	£721.00	£739.20	£865.20
MINI2H2613	200	2600	130	1948	6649	£650.00	£761.00	£780.00	£913.20

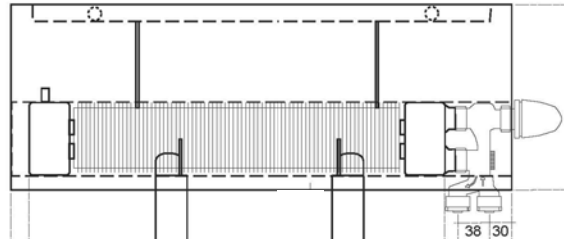

Mini	Edge of casing to first pipe centre	Pipe centres left to right
Mini	30mm	38mm
Pipe connections exit one end		

180mm deep

Model	Height A (mm)	Width B (mm)	Depth C (mm)	Watts Δt 50°C	Btu's Δt 50°C	White Ex VAT	Colours Ex VAT	White Inc VAT	Colours Inc VAT
MINI1H6018	130	600	180	499	1703	£356.00	£408.00	£427.20	£489.60
MINI1H8018	130	800	180	665	2270	£395.00	£456.00	£474.00	£547.20
MINI1H1018	130	1000	180	831	2836	£434.00	£502.00	£520.80	£602.40
MINI1H1218	130	1200	180	997	3403	£527.00	£614.00	£632.40	£736.80
MINI1H1418	130	1400	180	1163	3969	£554.00	£648.00	£664.80	£777.60
MINI1H1618	130	1600	180	1330	4539	£585.00	£684.00	£702.00	£820.80
MINI1H1818	130	1800	180	1496	5106	£616.00	£721.00	£739.20	£865.20
MINI1H2018	130	2000	180	1662	5672	£650.00	£761.00	£780.00	£913.20
MINI1H2218	130	2200	180	1828	6239	£691.00	£811.00	£829.20	£973.20
MINI1H2418	130	2400	180	1994	6806	£736.00	£864.00	£883.20	£1,036.80
MINI1H2618	130	2600	180	2161	7375	£767.00	£916.00	£920.40	£1,099.20
MINI2H6018	200	600	180	630	2150	£383.00	£442.00	£459.60	£530.40
MINI2H8018	200	800	180	840	2867	£424.00	£491.00	£508.80	£589.20
MINI2H1018	200	1000	180	1049	3580	£469.00	£545.00	£562.80	£654.00
MINI2H1218	200	1200	180	1259	4297	£571.00	£668.00	£685.20	£801.60
MINI2H1418	200	1400	180	1469	5014	£602.00	£704.00	£722.40	£844.80
MINI2H1618	200	1600	180	1679	5730	£633.00	£741.00	£759.60	£889.20
MINI2H1818	200	1800	180	1889	6447	£669.00	£784.00	£802.80	£940.80
MINI2H2018	200	2000	180	2099	7164	£706.00	£828.00	£847.20	£993.60
MINI2H2218	200	2200	180	2309	7881	£751.00	£882.00	£901.20	£1,058.40
MINI2H2418	200	2400	180	2519	8597	£799.00	£941.00	£958.80	£1,129.20
MINI2H2618	200	2600	180	2728	9311	£849.00	£1,001.00	£1,018.80	£1,201.20

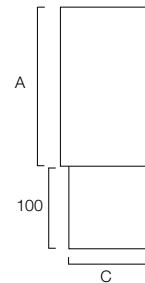

Mini shown on page 88



230mm deep

Model	Height A (mm)	Width B (mm)	Depth C (mm)	Watts Δt 50°C	Btu's Δt 50°C	White Ex VAT	Colours Ex VAT	White Inc VAT	Colours Inc VAT
MINI1H6023	130	600	230	680	2321	£410.00	£473.00	£492.00	£567.60
MINI1H8023	130	800	230	907	3096	£467.00	£542.00	£560.40	£650.40
MINI1H1023	130	1000	230	1134	3870	£510.00	£592.00	£612.00	£710.40
MINI1H1223	130	1200	230	1361	4645	£684.00	£800.00	£820.80	£960.00
MINI1H1423	130	1400	230	1588	5420	£708.00	£830.00	£849.60	£996.00
MINI1H1623	130	1600	230	1814	6191	£734.00	£860.00	£880.80	£1,032.00
MINI1H1823	130	1800	230	2041	6966	£760.00	£891.00	£912.00	£1,069.20
MINI1H2023	130	2000	230	2268	7741	£788.00	£925.00	£945.60	£1,110.00
MINI1H2223	130	2200	230	2495	8515	£842.00	£899.00	£1,010.40	£1,078.80
MINI1H2423	130	2400	230	2722	9290	£898.00	£1,056.00	£1,077.60	£1,267.20
MINI1H2623	130	2600	230	2948	10062	£956.00	£1,126.00	£1,147.20	£1,351.20
MINI2H6023	200	600	230	853	2911	£443.00	£512.00	£531.60	£614.40
MINI2H8023	200	800	230	1137	3881	£503.00	£584.00	£603.60	£700.80
MINI2H1023	200	1000	230	1421	4850	£551.00	£642.00	£661.20	£770.40
MINI2H1223	200	1200	230	1706	5823	£741.00	£869.00	£889.20	£1,042.80
MINI2H1423	200	1400	230	1990	6792	£770.00	£903.00	£924.00	£1,083.60
MINI2H1623	200	1600	230	2274	7761	£797.00	£937.00	£956.40	£1,124.40
MINI2H1823	200	1800	230	2559	8734	£827.00	£972.00	£992.40	£1,166.40
MINI2H2023	200	2000	230	2843	9703	£857.00	£1,008.00	£1,028.40	£1,209.60
MINI2H2223	200	2200	230	3127	10672	£918.00	£1,082.00	£1,101.60	£1,298.40
MINI2H2423	200	2400	230	3412	11645	£980.00	£1,155.00	£1,176.00	£1,386.00
MINI2H2623	200	2600	230	3696	12614	£1,043.00	£1,231.00	£1,251.60	£1,477.20

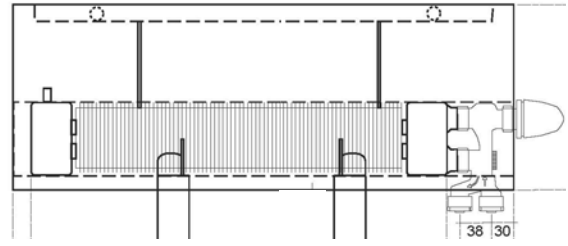

Mini	Edge of casing to first pipe centre	Pipe centres left to right
Mini	30mm	38mm
Pipe connections exit one end		

280mm deep

Model	Height A (mm)	Width B (mm)	Depth C (mm)	Watts Δt 50°C	Btu's Δt 50°C	White Ex VAT	Colours Ex VAT	White Inc VAT	Colours Inc VAT
MINI1H6028	130	600	280	817	2788	£467.00	£542.00	£560.40	£650.40
MINI1H8028	130	800	280	1089	3717	£532.00	£620.00	£638.40	£744.00
MINI1H1028	130	1000	280	1361	4645	£585.00	£681.00	£702.00	£817.20
MINI1H1228	130	1200	280	1633	5573	£816.00	£959.00	£979.20	£1,150.80
MINI1H1428	130	1400	280	1905	6502	£843.00	£992.00	£1,011.60	£1,190.40
MINI1H1628	130	1600	280	2178	7434	£872.00	£1,026.00	£1,046.40	£1,231.20
MINI1H1828	130	1800	280	2450	8362	£900.00	£1,058.00	£1,080.00	£1,269.60
MINI1H2028	130	2000	280	2722	9280	£929.00	£1,094.00	£1,114.80	£1,312.80
MINI1H2228	130	2200	280	2994	10219	£992.00	£1,079.00	£1,190.40	£1,294.80
MINI1H2428	130	2400	280	3266	11147	£1,058.00	£1,248.00	£1,269.60	£1,497.60
MINI1H2628	130	2600	280	3539	12079	£1,133.00	£1,338.00	£1,359.60	£1,605.60
MINI2H6028	200	600	280	1035	3532	£505.00	£586.00	£606.00	£703.20
MINI2H8028	200	800	280	1380	4710	£578.00	£673.00	£693.60	£807.60
MINI2H1028	200	1000	280	1725	5887	£631.00	£738.00	£757.20	£885.60
MINI2H1228	200	1200	280	2070	7065	£888.00	£1,046.00	£1,065.60	£1,255.20
MINI2H1428	200	1400	280	2414	8239	£918.00	£1,082.00	£1,101.60	£1,298.40
MINI2H1628	200	1600	280	2759	9416	£948.00	£1,117.00	£1,137.60	£1,340.40
MINI2H1828	200	1800	280	3104	10594	£980.00	£1,155.00	£1,176.00	£1,386.00
MINI2H2028	200	2000	280	3449	11771	£1,011.00	£1,193.00	£1,213.20	£1,431.60
MINI2H2228	200	2200	280	3794	12949	£1,084.00	£1,280.00	£1,300.80	£1,536.00
MINI2H2428	200	2400	280	4139	14126	£1,155.00	£1,364.00	£1,386.00	£1,636.80
MINI2H2628	200	2600	280	4484	15304	£1,239.00	£1,465.00	£1,486.80	£1,758.00

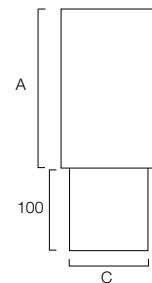
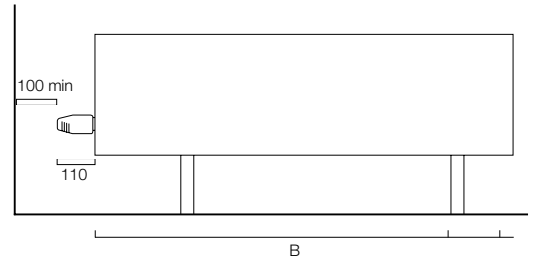

Non stock radiators are bespoke & made to order. Delivery times may be extended during factory holiday closures in Jul/Aug & Dec. Delivery times will be confirmed at time of order.





This is a list of standard sizes, our LST range is completely flexible on size, please contact us if you have a specific size or project requirement not covered by our standard options listed below.

Performance tested by BSRIA in accordance with NHS Estates Health Guidance Note “Safe hot water and surface temperatures” 1998.

400mm high

Model	Height A (mm)	Width B (mm)	Depth C (mm)	Watts Δt 50°C	Btu's Δt 50°C	White Ex VAT	White Inc VAT
LST4H6012	400	600	125	511	1744	£290.00	£348.00
LST4H8012	400	800	125	682	2328	£351.00	£421.20
LST4H1012	400	1000	125	852	2908	£404.00	£484.80
LST4H1212	400	1200	125	1022	3488	£442.00	£530.40
LST4H1612	400	1600	125	1363	4652	£530.00	£636.00
LST4H2012	400	2000	125	1704	5816	£632.00	£758.40
LST4H6017	400	600	175	734	2505	£325.00	£390.00
LST4H8017	400	800	175	978	3338	£387.00	£464.40
LST4H1017	400	1000	175	1223	4174	£450.00	£540.00
LST4H1217	400	1200	175	1468	5010	£500.00	£600.00
LST4H1617	400	1600	175	1957	6679	£606.00	£727.20
LST4H2017	400	2000	175	2446	8348	£742.00	£890.40

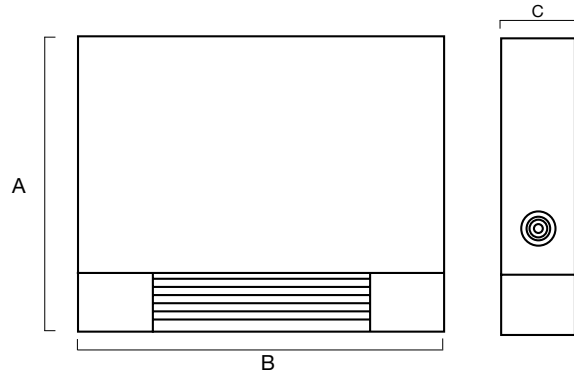

600mm high

Model	Height A (mm)	Width B (mm)	Depth C (mm)	Watts Δt 50°C	Btu's Δt 50°C	White Ex VAT	White Inc VAT
LST6H6012	600	600	125	667	2276	£308.00	£369.60
LST6H8012	600	800	125	890	3038	£370.00	£444.00
LST6H1012	600	1000	125	1112	3795	£426.00	£511.20
LST6H1212	600	1200	125	1334	4553	£473.00	£567.60
LST6H1612	600	1600	125	1779	6072	£563.00	£675.60
LST6H2012	600	2000	125	2224	7591	£675.00	£810.00
LST6H6017	600	600	175	942	3215	£336.00	£403.20
LST6H8017	600	800	175	1256	4287	£411.00	£493.20
LST6H1017	600	1000	175	1570	5358	£475.00	£570.00
LST6H1217	600	1200	175	1884	6430	£528.00	£633.60
LST6H1617	600	1600	175	2512	8573	£641.00	£769.20
LST6H2017	600	2000	175	3140	10717	£779.00	£934.80

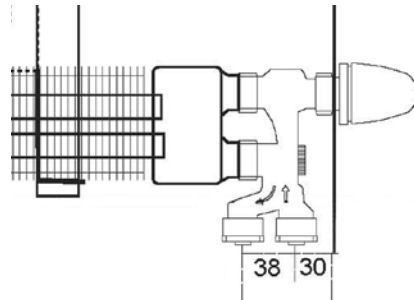

LST	Edge of casing to first pipe centre	Pipe centres left to right	Depth from wall to pipe centres
LST 125mm depth	30mm	38mm	65mm
LST 175mm depth	30mm	38mm	90mm

800mm high

Model	Height A (mm)	Width B (mm)	Depth C (mm)	Watts Δt 50°C	Btu's Δt 50°C	White Ex VAT	White Inc VAT
LST8H6012	800	600	125	717	2447	£328.00	£393.60
LST8H8012	800	800	125	956	3263	£387.00	£464.40
LST8H1012	800	1000	125	1196	4082	£450.00	£540.00
LST8H1212	800	1200	125	1435	4898	£499.00	£598.80
LST8H1612	800	1600	125	1913	6529	£596.00	£715.20
LST8H2012	800	2000	125	2391	8160	£714.00	£856.80
LST8H6017	800	600	175	1067	3642	£357.00	£428.40
LST8H8017	800	800	175	1423	4857	£435.00	£522.00
LST8H1017	800	1000	175	1778	6068	£500.00	£600.00
LST8H1217	800	1200	175	2134	7283	£559.00	£670.80
LST8H1617	800	1600	175	2845	9710	£677.00	£812.40
LST8H2017	800	2000	175	3556	12137	£826.00	£991.20

LST shown on page 89

All stocked radiators have prices listed in purple and will be delivered in 3 - 5 working days.

Standard LST supplied, white only including;

- Brackets
- Convector
- 1 piece outer casing with screws
- Bottom right Herz TRV valve

Note: Bottom left Herz TRV valve available at no additional cost; please specify at time of order.

Please specify LST optional extras at time of order:

Model	Description	Ex VAT	Inc VAT
AAPENPROOF	Pencil Proof Grille LST	£57.00	£68.40
AAANTIBACT	Anitbacterial paint	£57.00	£68.40
AAROMADV	Remote Adjustment Valve	£123.00	£147.60
WHERTAMP	Tamper Proof Valve	£102.00	£122.40

Note: Please specify right or left valve at time of order. Remote adjustment valves are top fittings & Hercules or the Standard Herz TRV valve are bottom fittings.

Easy to fit in 6 steps;

1. Measure & mount the brackets
2. Position Convector on brackets
3. Connect pipework to valve
4. Position casing
5. Connect valve head
6. Secure casing with screws

Note: Manufactured and tested to EN442, with a 5 year warranty

Plinth shown on page 88



Model	Height A (mm)	Width B (mm)	Watts Δt 50°C	Btu's Δt 50°C	Price Ex VAT	Price Inc VAT
PLINHYDR	100	500	2051	7000	£357.00	£428.40
PLINELEC	100	500	2000	N/A	£177.00	£212.40

Plinth Hydronic

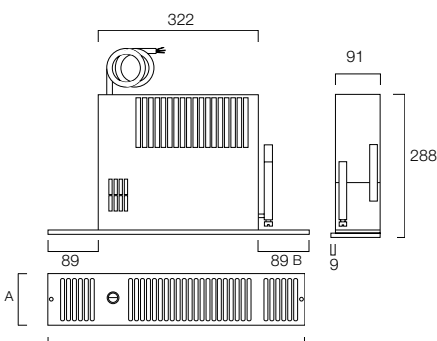

Plinth Electric

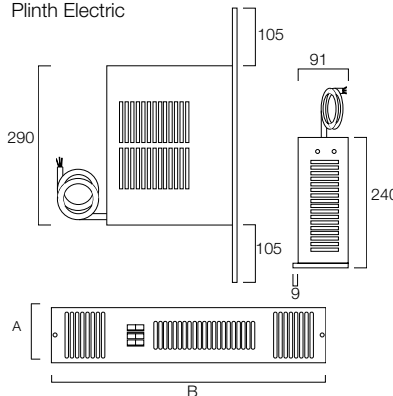

Trench shown on page 90



Trench 300mm Depth

Model	Length A (mm)	Width B (mm)	Watts Δt 50°C	Btu's Δt 50°C	Price Ex VAT	Price Inc VAT
TREN3D8028	800	280	390	1331	£473.00	£567.60
TREN3D8036	800	360	581	1983	£562.00	£674.40
TREN3D8046	800	460	755	2577	£663.00	£795.60
TREN3D1028	1000	280	546	1863	£567.00	£680.40
TREN3D1036	1000	360	815	2782	£674.00	£808.80
TREN3D1046	1000	460	1061	3621	£803.00	£963.60
TREN3D1228	1200	280	700	2389	£662.00	£794.40
TREN3D1236	1200	360	1045	3567	£791.00	£949.20
TREN3D1246	1200	460	1370	4676	£935.00	£1,122.00
TREN3D1428	1400	280	859	2932	£731.00	£877.20
TREN3D1436	1400	360	1285	4386	£903.00	£1,083.60
TREN3D1446	1400	460	1687	5758	£1,076.00	£1,291.20
TREN3D1628	1600	280	1030	3515	£849.00	£1,018.80
TREN3D1636	1600	360	1525	5205	£1,020.00	£1,224.00
TREN3D1646	1600	460	2027	6918	£1,215.00	£1,458.00
TREN3D1828	1800	280	1200	4096	£945.00	£1,134.00
TREN3D1836	1800	360	1780	6075	£1,131.00	£1,357.20
TREN3D1846	1800	460	2353	8031	£1,351.00	£1,621.20
TREN3D2028	2000	280	1370	4676	£1,043.00	£1,251.60
TREN3D2036	2000	360	2043	6973	£1,250.00	£1,500.00
TREN3D2046	2000	460	2693	9191	£1,485.00	£1,782.00
TREN3D2228	2200	280	1548	5283	£1,136.00	£1,363.20
TREN3D2236	2200	360	2306	7870	£1,364.00	£1,636.80
TREN3D2246	2200	460	3049	10406	£1,624.00	£1,948.80
TREN3D2428	2400	280	1734	5918	£1,233.00	£1,479.60
TREN3D2436	2400	360	2569	8768	£1,481.00	£1,777.20
TREN3D2446	2400	460	3405	11621	£1,762.00	£2,114.40

Please note.

Trench units are sold with all internal components and your choice of wood or metal grille.

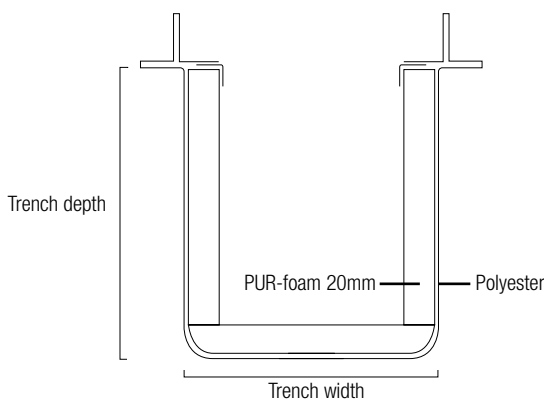

This is the standard Trench profile suited to new builds. The frame protrudes from the sides to allow screed for flooring to be laid over the frame. The Trench frame is recessed 30 x 30 x 3mm for wood grilles and 25 x 35 x 3mm for aluminium grilles.

Please Note:

Standard new build trench units will be made of Polyethylene, retro fit models will be made of fibreglass.

Trench 520mm Depth

Model	Length A (mm)	Width B (mm)	Watts Δt 50°C	Btu's Δt 50°C	Price Ex VAT	Price Inc VAT
TREN5D8028	800	280	489	1669	£504.00	£604.80
TREN5D8036	800	360	727	2481	£597.00	£716.40
TREN5D8046	800	460	945	3225	£701.00	£841.20
TREN5D1028	1000	280	683	2331	£608.00	£729.60
TREN5D1036	1000	360	1017	3471	£717.00	£860.40
TREN5D1046	1000	460	1328	4532	£844.00	£1,012.80
TREN5D1228	1200	280	875	2986	£691.00	£829.20
TREN5D1236	1200	360	1306	4457	£835.00	£1,002.00
TREN5D1246	1200	460	1713	5846	£981.00	£1,177.20
TREN5D1428	1400	280	1074	3666	£783.00	£939.60
TREN5D1436	1400	360	1606	5481	£957.00	£1,148.40
TREN5D1446	1400	460	2109	7198	£1,126.00	£1,351.20
TREN5D1628	1600	280	1287	4393	£906.00	£1,087.20
TREN5D1636	1600	360	1906	6505	£1,074.00	£1,288.80
TREN5D1646	1600	460	2534	8649	£1,267.00	£1,520.40
TREN5D1828	1800	280	1500	5120	£1,007.00	£1,208.40
TREN5D1836	1800	360	2225	7594	£1,194.00	£1,432.80
TREN5D1846	1800	460	2941	10038	£1,410.00	£1,692.00
TREN5D2028	2000	280	1713	5846	£1,110.00	£1,332.00
TREN5D2036	2000	360	2554	8717	£1,314.00	£1,576.80
TREN5D2046	2000	460	3366	11488	£1,545.00	£1,854.00
TREN5D2228	2200	280	1935	6604	£1,208.00	£1,449.60
TREN5D2236	2200	360	2883	9840	£1,436.00	£1,723.20
TREN5D2246	2200	460	3811	13007	£1,692.00	£2,030.40
TREN5D2428	2400	280	2167	7396	£1,349.00	£1,618.80
TREN5D2436	2400	360	3211	10959	£1,554.00	£1,864.80
TREN5D2446	2400	460	4256	14526	£1,831.00	£2,197.20

Please note.

Trench units are sold with all internal components and your choice of wood or metal grille.

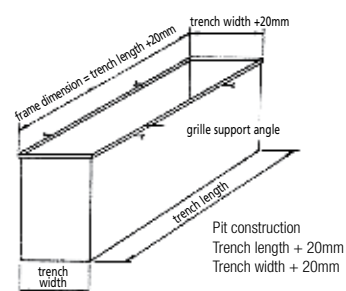
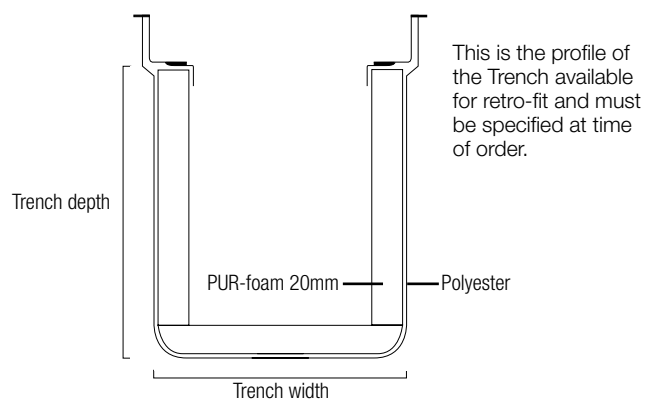



Trench 620mm Depth

Model	Length A (mm)	Width B (mm)	Watts Δt 50°C	Btu's Δt 50°C	Price Ex VAT	Price Inc VAT
TREN6D8028	800	280	537	1833	£573.00	£687.60
TREN6D8036	800	360	793	2707	£677.00	£812.40
TREN6D8046	800	460	1026	3502	£793.00	£951.60
TREN6D1028	1000	280	750	2560	£693.00	£831.60
TREN6D1036	1000	360	1115	3805	£814.00	£976.80
TREN6D1046	1000	460	1453	4959	£952.00	£1,142.40
TREN6D1228	1200	280	967	3300	£802.00	£962.40
TREN6D1236	1200	360	1441	4918	£847.00	£1,016.40
TREN6D1246	1200	460	1886	6437	£1,106.00	£1,327.20
TREN6D1428	1400	280	1190	4061	£920.00	£1,104.00
TREN6D1436	1400	360	1779	6072	£1,080.00	£1,296.00
TREN6D1446	1400	460	2321	7922	£1,267.00	£1,520.40
TREN6D1628	1600	280	1431	4884	£1,033.00	£1,239.60
TREN6D1636	1600	360	2128	7263	£1,216.00	£1,459.20
TREN6D1646	1600	460	2786	9509	£1,429.00	£1,714.80
TREN6D1828	1800	280	1664	5679	£1,146.00	£1,375.20
TREN6D1836	1800	360	2476	8451	£1,349.00	£1,618.80
TREN6D1846	1800	460	3250	11092	£1,590.00	£1,908.00
TREN6D2028	2000	280	1906	6505	£1,264.00	£1,516.80
TREN6D2036	2000	360	2843	9703	£1,486.00	£1,783.20
TREN6D2046	2000	460	3733	12741	£1,740.00	£2,088.00
TREN6D2228	2200	280	2128	7263	£1,377.00	£1,652.40
TREN6D2236	2200	360	3211	10959	£1,624.00	£1,948.80
TREN6D2246	2200	460	4217	14393	£1,915.00	£2,298.00
TREN6D2428	2400	280	2418	8253	£1,493.00	£1,791.60
TREN6D2436	2400	360	3578	12212	£1,760.00	£2,112.00
TREN6D2446	2400	460	4720	16109	£2,059.00	£2,470.80
TREN6D2628	2600	280	2669	9109	£1,610.00	£1,932.00
TREN6D2636	2600	360	3966	13536	£1,893.00	£2,271.60
TREN6D2646	2600	460	5223	17826	£2,223.00	£2,667.60

Please note.

Trench units are sold with all internal components and your choice of wood or metal grille.

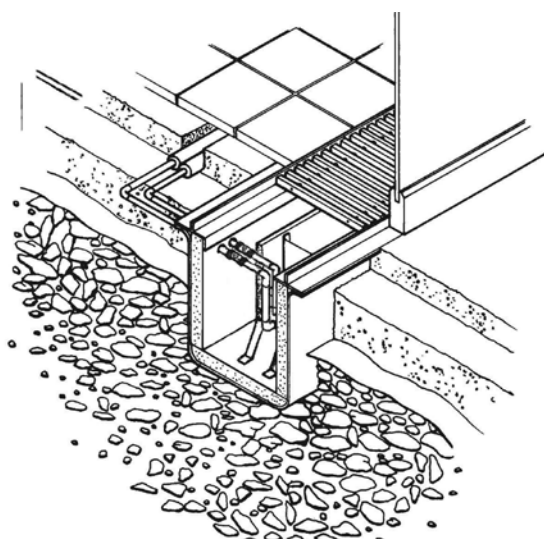

This illustration below shows a typical installation. Please note how the pipe work enters the Trench unit just below the frame prior to connection with the convector unit.

Please Note:

The Trench is available in standard sizes upto 2600mm, larger bespoke sizes can be provided in two formats;

1. For lengths over 2600mm we will normally quote on supplying separate trench units to fill the required dimensions. These are supplied with extended grille rails to allow for a continuous run of the grille covering.

2. A complete Trench unit up to 6000mm can be manufactured however these models will incur additional transport costs due to their size. For full details and to discuss your specific requirements please contact **01342 302250**.

An exploded drawing showing the various components of the Trench

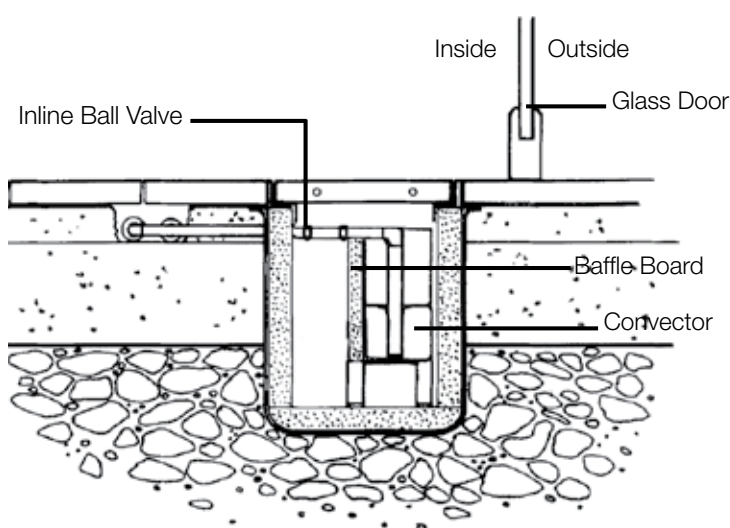
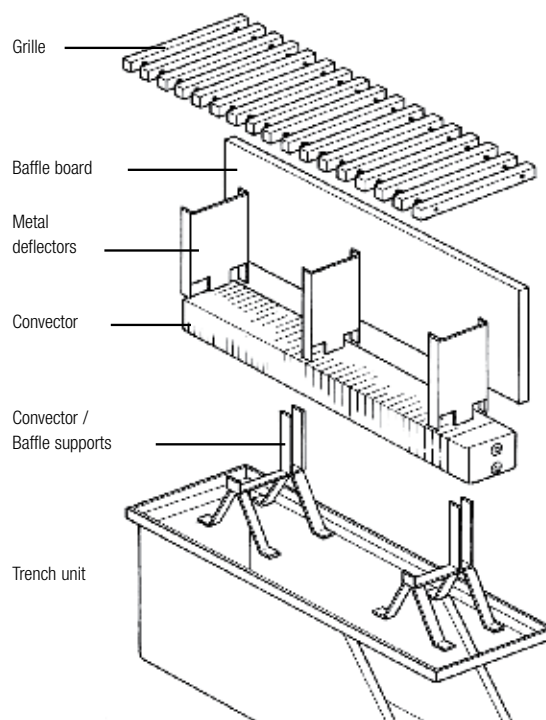

This cross section above shows the correct installation for the Trench unit. Please note the position of the Convector Unit against the outside edge with the baffle board in the centre of the Trench



Helpful Advice

Made to Order

We pride ourselves in having the widest range of sizes, options, colours and accessories so that you have literally thousands of options to choose from.

This means that you can have almost any radiator made to order so that it perfectly suits the space you have available, your interior design and it will also match your heat requirements.

Colour Options

Many of our designs are available in a large selection of RAL colours (188 internationally recognised paint colours) and Special Finishes. If you would like a copy of our RAL or Special Finish chart please contact us on 01342 302250. *Please note that due to the printing process and manufacturing tolerances the colour (including white) of a finished radiator may vary slightly from the colours represented in the brochure and from one colour group to another as well as from our Special Finish & RAL charts. It should also be noted that if the same type of Radiators are ordered and produced they may also differ in finished colour from any previously ordered.*

Stock

To provide the best possible service we hold the most popular sizes of white and chrome models in stock. So if you need quick delivery look in the technical section for models listed with purple prices; these can usually be delivered within 3-5 working days.

How much heat?

We always recommend you choose radiators with a higher output than required, as you can always turn them down and have the reassurance of additional heat in really cold spells.

How is heat output measured?

There are two recognised measurements for heat output; BTU's (British Thermal Unit) and Watts. Within this brochure you will find both listed in the technical section by each radiator.

Delta T's

The heat output of a radiator is established using a calculation called a delta t (Δt), based on a desired room temperature of 20°C and boiler flow and return temperatures; European standards use delta t50°C as a measurement, this is based on a boiler flow temperature of 80°C and a return of 60°C ($80^\circ\text{C} + 60^\circ\text{C} \div 2 - 20^\circ\text{C} = 50^\circ\text{C}$). Some systems using renewable energy sources may have different flow and returns and therefore different delta t's (e.g. $60^\circ\text{C}/40^\circ\text{C} = \text{Delta } t30^\circ\text{C}$). If you require outputs based on alternative delta's please contact us on 01342 302250.

EN442

All our radiators are produced and outputs measured according to the European standard EN442. This standard uses Delta t50°C to provide a consistent and comparative output measurement for all radiators.

How can I find out what heat outputs I need?

Your installer should be able to confirm the exact requirements for each of your rooms, but you can also visit our website and use our online calculator or use the following simple calculation as a guide;

1. Find the volume of your room in cubic feet = Height x width x length (To convert cubic meters into cubic feet multiply the total figure by 35.31).
2. Multiply the volume by 6 to find the BTU requirement. If you need to know the Watts equivalent, divide your BTU by 3.412.

For example:

A bathroom 6'x8' with 8' ceilings = a volume of 384 cubic feet multiply by 6 = 2304 BTUs

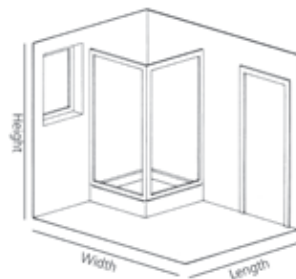

You may need more than 1 radiator in order to ensure an even distribution of heat in a large room, if so divide the required output by the total number of radiators you could sensibly place in the room.

e.g. a lounge 14' x 18' x 8' ceilings = 12096 BTUs.

Two radiators would require an output of = 6048 BTUs each, 3 radiators = 4032 BTUs each

Do different designs affect output?

By altering the size, shape or number of tubes or columns in a radiator you can adjust the output achieved.

For example the multiple column of our Ancona range provide huge flexibility in achieving the right output in a limited space.



Single double or triple radiators

Using models with additional rows of tubes or multiple columns maximises heat output within the same wall space.

Our Volcano design comes in single or double versions, as an example of comparative heat outputs:

Volcano single 1471mm x 400mm = 3440 BTUs

Volcano double 1471mm x 400mm = 5734 BTUs

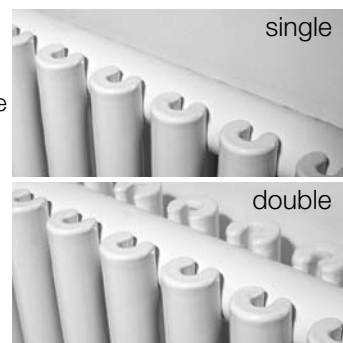

Horizontal or Vertical;

Many of our designs are available in horizontal or vertical options which means you can maximise the use of ceiling heights and long low spaces, without losing output.

How to order

Order your radiator in six easy steps

1. **Confirm your Heat Output requirements;** this ensures the radiators you choose will deliver the heat output you need (see page 160 or visit www.theradiatorcompany.co.uk).
2. **Choose your Design;** our range has everything from traditional cast iron to modern feature radiators (even an environmentally friendly aluminium range), with an extensive choice of sizes, colours & outputs.
3. **Select a Size that matches the heat output requirement;** outputs are shown in our technical section and will help you and your installer to find the best match for your needs.
4. **Choose the Colour you want;** with over 200 colours and special finishes you are able to match your colour scheme or introduce an accent colour to create a striking feature.
5. **Find a Valve;** to complete the look choose from our wide selection of valves and add any accessories that complement your choice.
6. **Order from your nearest Showroom or Merchant;** to find your nearest branch call us on 01342 302250 or visit www.theradiatorcompany.co.uk.

Our Product Range

- All our radiators are produced and outputs measured in accordance with European standard EN442.
- Radiators are supplied with BOE connections as standard unless stated otherwise; B2 underneath connections can be supplied with selected models. Full technical details can be found from pages 106 to 159 and all details are in accordance with our manufacturing partner's terms of reference at the time of going to print.
- All suitable radiators and towel radiators are supplied with an Aladdin HV30 auto vent, this product does not have a replaceable cartridge and therefore differs from the HV30C listed in the accessories section of the brochure.
- Due to the excessively corrosive nature of chlorine we do not recommend that radiators & towel rails are placed in swimming pool environments. In addition radiators should not be located in areas that have long term exposure to high levels of moisture.
- When commissioning any radiator (including aluminium) on an indirect/closed system we recommend using a suitable mixed metal inhibitor in suitable quantities to protect against scale & corrosion.

Terms & Conditions

For a copy of The Radiator Company full Terms & Conditions please call our Customer Services department on **01342 302250** or visit www.theradiatorcompany.co.uk

Electric / Dual Application

The majority of our towel rails can be converted to work as dual application models. An element and T piece is needed to adapt the towel rail; your installer will need to be aware if you wish to do this in order to adjust pipe centres accordingly. See pages 104 - 105 for our range of elements. If a towel rail is suitable for dual application it will be noted in the Product Information box.

Pipe Centres

We endeavour to ensure all pipe centres are correct, however manufacturing tolerances must be considered; therefore we strongly recommend that pipe work is not altered or adjusted until your new radiator or towel rail is delivered. The Radiator Company will not accept any responsibility for claims resulting from incorrect pipe centres.

Delivery

Please note that many of our factories close for 2 – 4 weeks during the holiday periods of July/August and December. This may extend the delivery period quoted for non stock, made to order, items ordered during July/August and December/January. We will confirm the expected delivery date on our order acknowledgment at the time of order. Deliveries will be made to the nearest hard standing area.

Systems

All Radiators and Towel Rails featured in this brochure are suitable for indirect/closed systems that comply with 'BS5449, section 1 forced circulation hot water systems'. Selected lines are suitable for a direct system. Direct heating systems use your hot water supply to heat a radiator; usually this will occur in a bathroom. If you have any radiators or towel rails linked to a direct system they should be made from either stainless steel or brass to avoid rusting and contaminating the hot water supply.

Thank You

We are very grateful to the following for their assistance in producing our brochure;

Jennie Li Roberts; Artist
www.jennieroberts.co.uk, **Mobile: 07738 974 743**

Paint & Paper Library; Paint specialists
www.paintlibraryco.uk

East Grinstead Bathrooms & Kitchens;
www.egbandk.com, **Tel: 01342 319 111**

Questions & Answers

The following Q&As are based on questions posed by our Customers in relation to leaking, damaged, scratched or imperfect radiators.

Should the answer to your question not be on the list or should you just wish to talk with one of our team, please do not hesitate to contact our Customer Service team on 01342 302250 or e-mail us on sales@theradiatorcompany.co.uk.

For a copy of The Radiator Company full Terms & Conditions of sale please call our Customer Services department on 01342 302250 or visit our website at www.theradiatorcompany.co.uk.

Q. [Will you replace my leaking radiator?](#)

A. If your radiator is leaking and the leak is not from where the valves connect to the radiator or where the airvent is fitted (in which case this is almost certainly an installation problem), then yes we will replace your radiator. The Radiator Company may choose to replace just the damaged or leaking sections of a sectional radiator, however the radiator will still look and work perfectly.

Q. [Will you replace my scratched, damaged or imperfect radiator?](#)

A. Yes, The Radiator Company will replace all scratched, damaged or imperfect radiators, as long as they have not been installed and we are notified within 28 days of the signed delivery note. We would also ask that they are available to be returned to us at the time of the replacement, in their original condition and packaging.

Q. [Why do I need to return the leaking, damaged, scratched or imperfect radiator?](#)

A. As with other companies who supply high quality products (e.g. kitchen appliances), TRC require the return of the damaged item for quality checking and safe disposal or recycling of materials; a full credit cannot be given unless the damaged radiator is returned.

Q. [Why does the radiator need to be in its original packaging?](#)

A. It is important for all scratched, damaged or imperfect radiators to be in their original packaging so that they are protected when they are being returned and so that we can also determine if they were scratched or damaged pre or post delivery. Leaking radiators do not have to be in their original packaging but we would ask that they are packaged as well as possible for transport, to prevent further damage prior to quality checking.

Q. [Will the replacement take as long to arrive as my original order?](#)

A. We hope to be able to replace your radiator as quickly as possible and it should be faster than your original order; we will also try to keep you informed throughout the process. Please see notes on delivery in our Terms & Conditions, please call our Customer Services department on **01342 302250** or visit our website at **www.theradiatorcompany.co.uk**.

Q. [Will I be charged if I do not return the damaged or leaking radiator after The Radiator Company has delivered the replacement?](#)

A. Should you not return the damaged or leaking radiator, The Radiator Company will invoice you for the full value of the replacement radiator 60 days after the replacement radiator has been delivered.

Q. [Do I need to arrange for the return of the damaged, scratched or leaking radiator to The Radiator Company?](#)

A. The Radiator Company will arrange for the collection of the damaged or leaking radiator from the relevant Merchant who placed the original order. They should contact us as soon as it is available for us to collect, however we do have a process that chases returns.

Q. [Why does The Radiator Company limit its liability just to the free of charge replacement of the radiator?](#)

A. The Radiator Company has adopted the same policy as all other companies who sell high value household products and we offer free of charge replacements for all damaged, leaking, scratched or imperfect products, as long as our terms and conditions of sale have been met.

Q. [Why is there is a restocking charge for cancelled or changed orders?](#)

A. All stock orders can be changed or cancelled prior to despatch with no charge. To cover administration and transportation costs stock orders cancelled after despatch will be subject to a minimum 15% restocking charge; as long as they are returned in their original packaging, original condition and undamaged. However for all non stock radiators, these are bespoke and made to order, therefore they will have been manufactured specifically for the customer who orders them and are unlikely to be able to be re-sold, hence the restocking charge to cover production and administration costs; we always notify the expected restock charge in case of change or cancellation of an order on our order acknowledgement.

We hope that you will find us a fair company to deal with and that our policies reflect those of similar companies that sell high value household items such as kitchen appliances.

Should you ever have a complaint about the company or our service, please write to;

The Managing Director
The Radiator Company Limited
Units 13-14 Charwoods Road
East Grinstead
West Sussex
RH19 2HU.

Registered in England No. 3596023



TRC 35 single vertical 1700 x 488 shown in RAL 9010.