



IP65 BAR GROW LIGHT

70W / 100W / 140W

2017-09-14

Product Design > ID

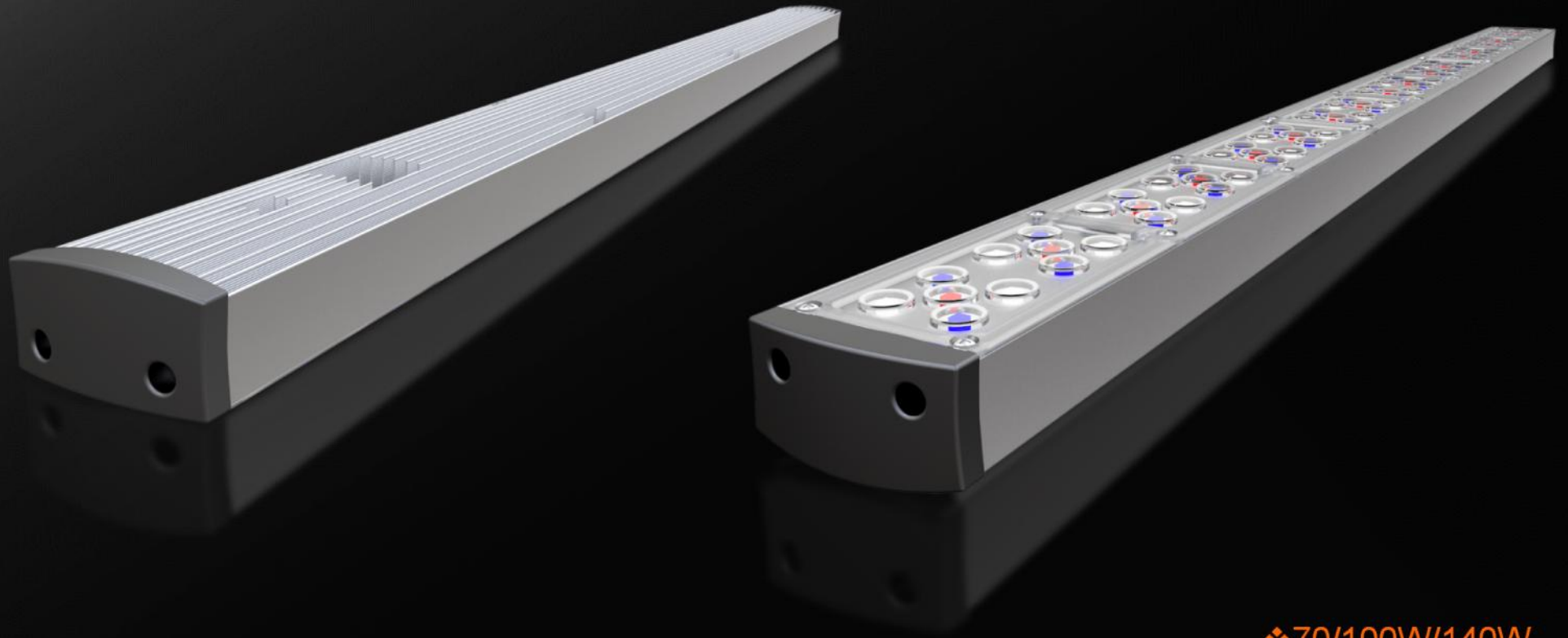

❖ 70/100W/140W
IP65

Product Design > ID



❖ 70W/100W/140
IP65

Product Design > Optics lens

90° Distribution

With a highly-focused beam pattern, this distribution option delivers exceptional depth penetration into the plants.

120° Distribution

Offers exceptional uniformity—enabling wider spacing so growers can achieve desired light levels evenly across the surface of the crop, with fewer modules.



❖ 90° beam angle

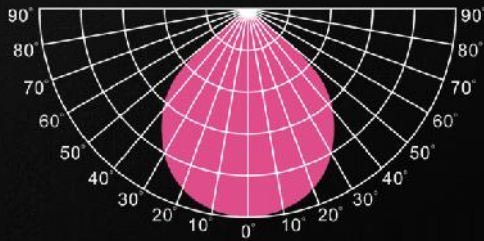

❖ 120° beam angle

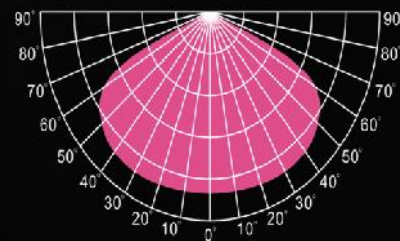

Product Design > Color ratio

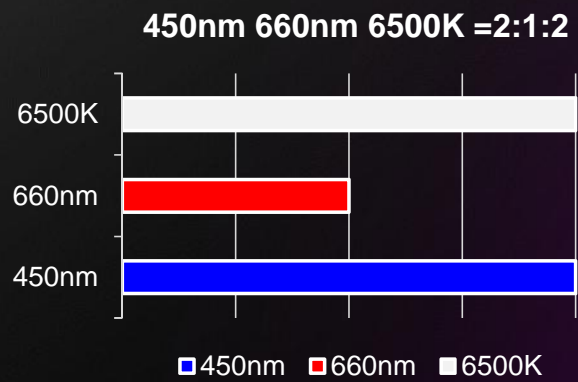

5 in 1 optics lens, color ratio could be customized ;

Product Design > 调光方式

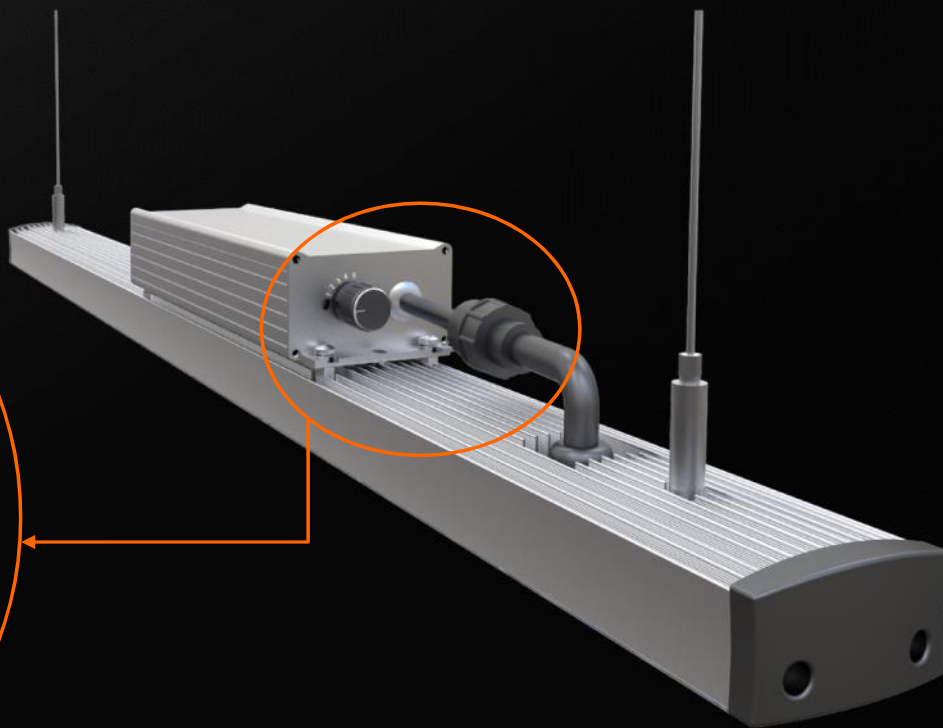
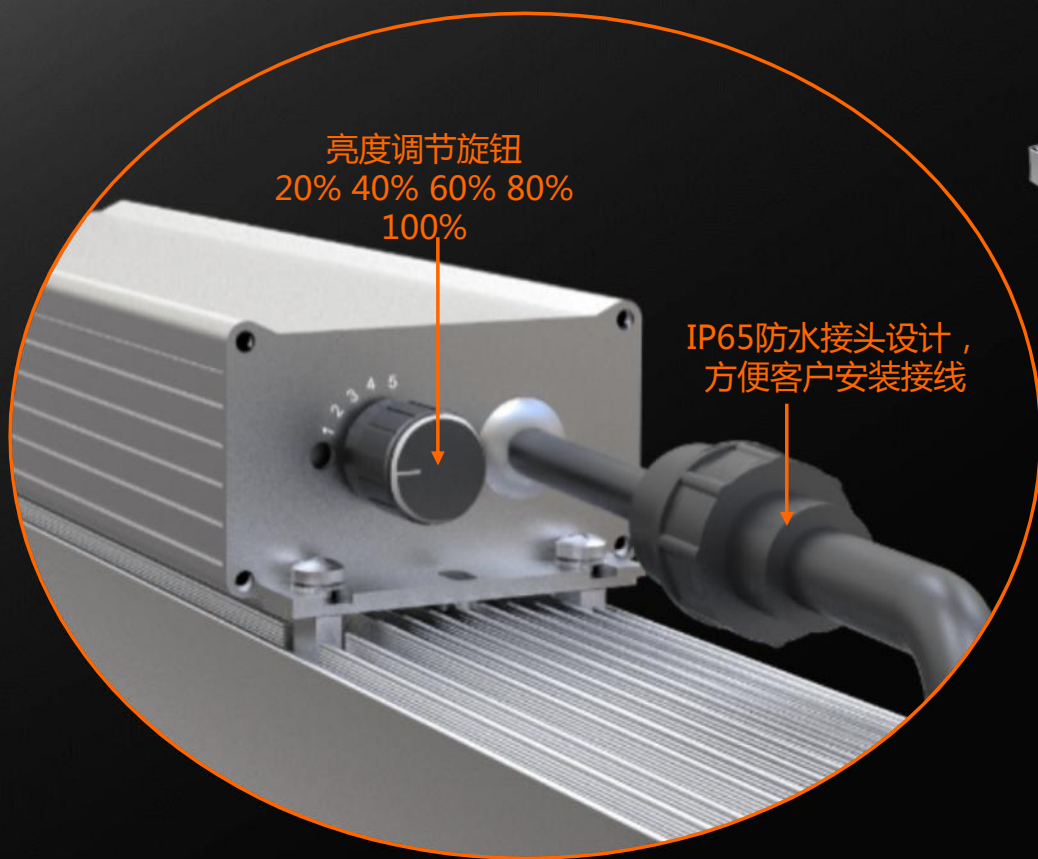

Product Design > Parameter

Items	IP65 BAR GROW LIGHT		
Length	2Ft	3Ft	4Ft
Lamp power (W)	70W	100W	140W
wavelength	450 660 6500K	450 660 6500K	450 660 6500K
Color ratio	2:1:2	2:1:2	2:1:2
Light source	Osram 3030 60pcs	Osram 3030 90pcs	Osram 3030 120pcs
P.F	0.9		
Angle	90° / 120°		
Material Science	Al		
IP	65		
Lifetime (hr)	50000		
PPF	TBD		
Voltage (V)	100-277		

Product Design > Dimension

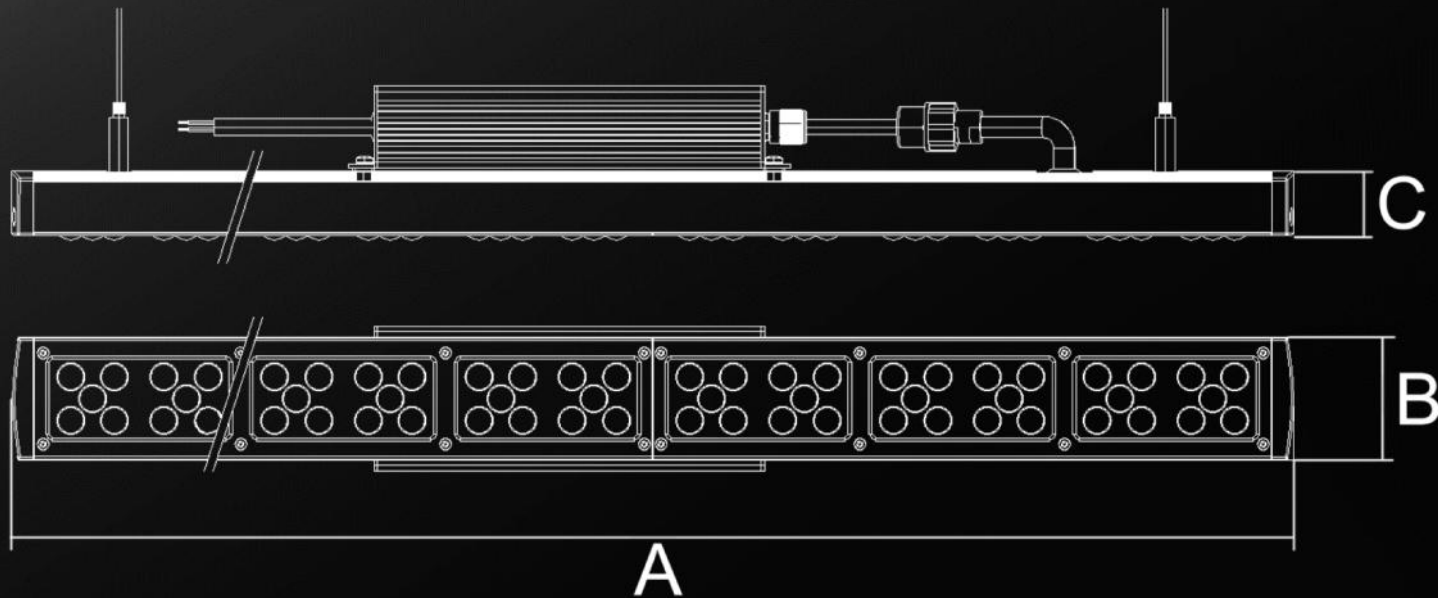

	A	B	C
2FT	600mm	57.5mm	30mm
3FT	900mm	57.5mm	30mm
4FT	1200mm	57.5mm	30mm

Product Design > Advantages

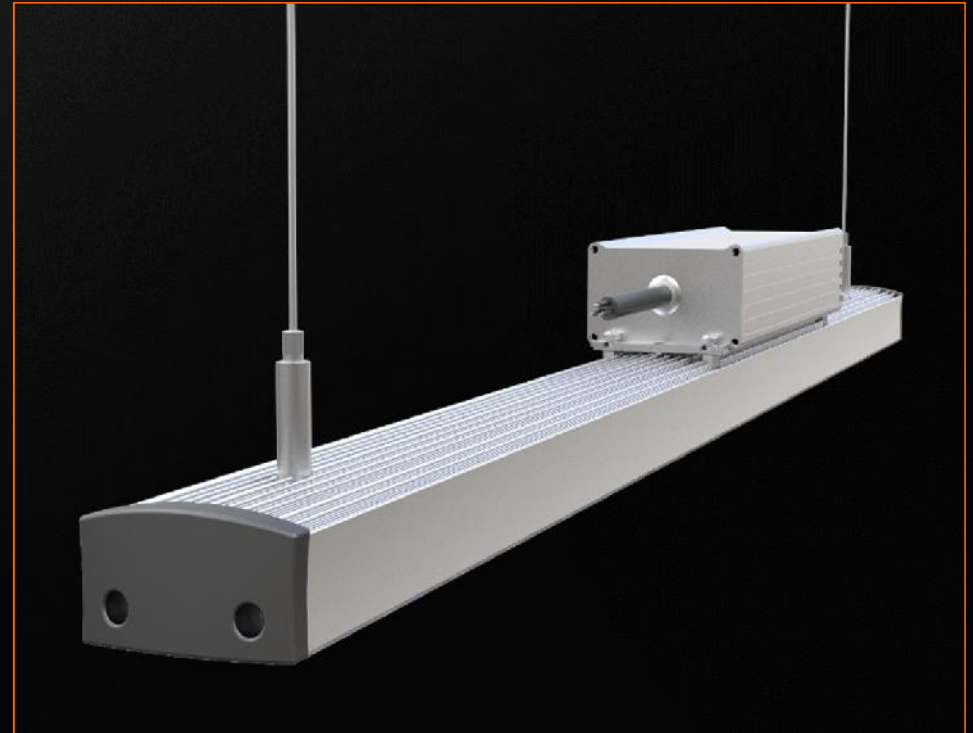

SPECS:

The integrated fins on the top of each module are thermally and mechanically engineered to dissipate heat through conduction and convection paths-minimizing LED junction temperature and maximizing light output, lifetime and reliability

Product Design > Advantages



SPECS:

- 1、 External led driver which is easy to replace once broken ,
- 2、 IP 65 waterproof design which is widely used in greenhouse;
- 3、 Easy maintain;
- 4、 LED driver and fixture could be packed alone which is to save shipping;
- 5、 Flexible interlock design, DIY for end users
- 6、 Dimming option for 0-10V control or dimmer manual control;

Product Design > Application





Your Trustworthy Partner !