



INVERTER

Model

**FR-F700**

*Changes for the Better*

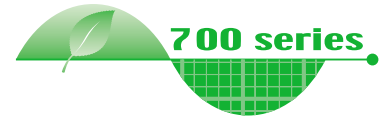

*The energy saving effect is obvious*

**Lineup complete**

**Energy saving inverter**

**F700 series is now available**



Mitsubishi Electric Corporation Nagoya Works is a factory certified for ISO14001 (standards for environmental management systems) and ISO9001 (standards for quality assurance management systems)



# Evolution of the inverter for fan and pump applications, energy savings for buildings and factories as a whole



## 1. More Energy Savings

### (1) Upgrade of the renown Optimum Excitation Control!!

• Achieved a higher level of energy savings during acc./dec. to say nothing of during constant speed.

[Ex. of Blower Operation Characteristics]

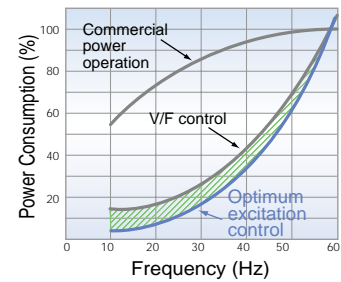

[Ratio of Motor Power Consumption during Acc./Dec.]

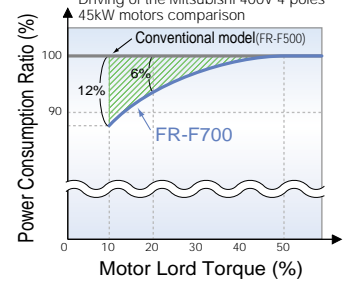

### (2) The effect of energy savings is obvious A

• The effect of energy savings can be confirmed using the operation panel, output terminal (FM, AM terminal) and via networks with the newly developed energy saving monitor.

Ex. of Power Savings Monitor Display



[Energy Saving Monitor List]

- Power saving monitor (kW)
- Power saving rate (%)
- Power saving amount (kWh)
- Power saving amount charge (\$)
- Power saving average value (kW)
- Power saving rate average value (%)
- Power saving charge average value (\$)
- Annual power saving amount (kWh)
- Annual power saving amount charge (\$)



## 2. Ideal for Fans and Pumps

### (1) Adjustable 5 points V/F

• Possible to set the torque pattern that is optimum for the machine's characteristic  
• Possible to expect even more energy savings with optimum excitation control and optimum V/F pattern working together

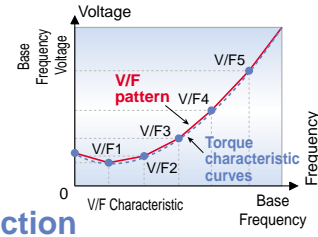

### (2) Enhanced PID function

• Energy savings in low speed region ... PID shutoff (sleep control) function  
• Shorter PID startup time ... PID automatic switchover function  
• Monitor of set point/measured value/deviation possible ... PID monitor  
• Convenient for HVAC usage ... forward/reverse operation switchover is simple with an external signal  
• Corresponds to a wide range of detectors ... set point and measured value for PID input can either be voltage (0 to 5V/0 to 10 V) or current (4 to 20mA)

### (3) Adoption of the original operation continuation at instantaneous power failure function

• Operation continues without the motor coasting when an instantaneous power failure occurred in fan and blower applications.  
\*The inverter may trip and the motor may coast depending on the load condition.

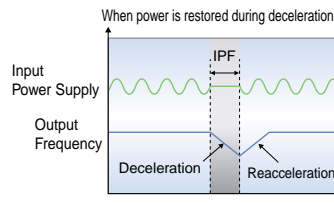

### (4) Restart after instantaneous power failure function

• Restart can be made without stopping the motor when the motor is coasting due to an instantaneous power failure.

### (5) Flying start

• Smoothly restarts a motor that is rotating even in the opposite direction due to the windmill effect.

### (6) Regeneration avoidance function

• Possible to avoid regeneration overvoltage alarm by automatically increasing the frequency and continue operation if the fan happens to rotate faster due to the effect of another fan in the same duct.

### (7) PTC thermistor input I

• Protection of the motor can be certain since the built-in PTC of the motor can be input directly in addition to the electronic thermal relay function.  
PTC thermistor input ... Positive Temperature Coefficient Thermistor

### (8) Commercial power-supply switchover sequence

• Switchover to commercial power-supply operation is simple using R1 and S1 terminals of the control circuit and commercial power-supply switchover sequence.



## 3. Long Life and Simple Maintenance

### (1) Operating life of parts are further lengthened

• Adoption of newly developed long life cooling fan (design life of 10 years\*)  
Longer operating life is further enhanced with the use of ON/OFF control of cooling fan.  
• Adoption of long life capacitor (design life of 10 years\*1, 2)  
A capacitor with specification of 5000 hours at 105°C ambient temperature is adapted.  
\*1 Ambient temperature: yearly average 40°C (free from corrosive gas, flammable gas, oil mist, dust and dirt)  
Since the design life is a calculated value, it is not a guaranteed value.  
\*2 Output current: 80% of the rated current of Mitsubishi standard 4P motor

### (2) State of the art longevity diagnostic method

• Degrees of deterioration of main circuit capacitor, control circuit capacitor or inrush current limit circuit can be diagnosed by monitor.  
• Trouble can be avoided with the self-diagnostic alarms\* that is output when the life span is near.  
\*Any of alarm for main circuit capacitor, control circuit capacitor, inrush current limit circuit and cooling fan can be output.

### (3) Maintenance timer

• Maintenance timer output function can also inform of maintenance time for peripheral equipments.  
• Average output current value and maintenance timer value are output as pulses.

### (5) Improved workability

- **Easy replacement of cooling fan C**
  - The installation position of the cooling fan is in the upper portion of the inverter.
  - Fan replacement is easily done without having to remove the main circuit wires.
- **Wiring is easy with the combed shaped wiring cover D**
  - Wiring cover can be reinstalled after wiring.
  - (200V class 22K or less, 400V class 30K or less)

### (4) Update is also easy

• **Removable terminal block B**  
• When exchanging the inverter, the control circuit terminals can be exchanged.  
The removable terminal block of the FR-F500 series can be used.  
(The terminal block of the FR-F700 series is compatible with that of the FR-F500 series.  
Note that some functions of the FR-F700 series are restricted when using the terminal block of the FR-F500 series.)

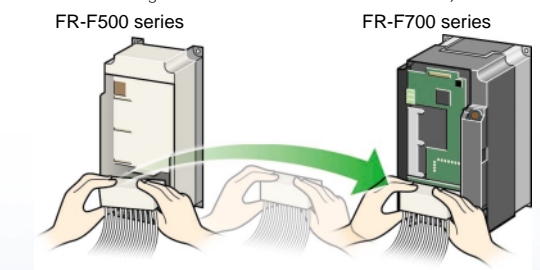

- **Possible to copy parameters with operation panel A**
  - Parameter setting for multiple inverters is simple by copy with the operation panel.
- **Alarm history**
  - Alarm history (alarm details and frequency, current, voltage and cumulative energization time at time of alarm occurrence) can be displayed on the operation panel and the cause of a trouble can be checked. (up to 8 past alarms)

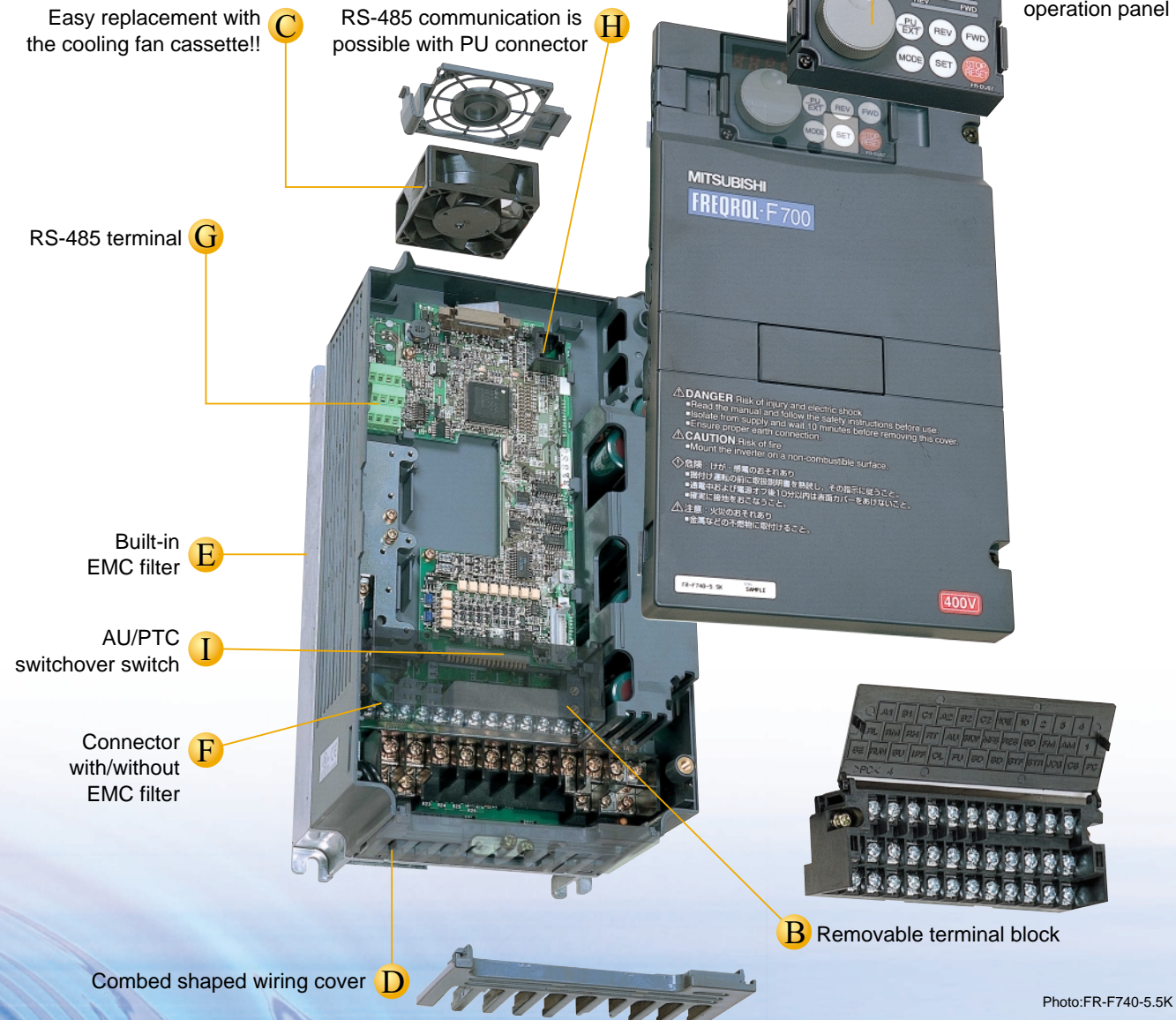

Photo:FR-F740-5.5K

Features	1
Connection with Peripheral Devices	5
Why can the inverter save energy?	
Standard Specifications	7
Outline Dimension Drawings	9
Terminal Connection Diagram	16
Terminal Specification Explanation	
Explanation of the Operation Panel (FR-DU07)	19
Parameter List	21
Explanations of Parameters	28
Protective Functions	47
Option and Peripheral Devices	49
Precautions for Operation/Selection	59
Precautions for Peripheral Device Selection	
Application to Motor	63
Main differences and compatibilities with the FR-F500(L) series	64
Warranty	65
International FA center	66

# Full of attractive features!

## 4. Free of Environmental Worries

### (1) Reduction of electromagnetic noises **E F**

- Inverter noises have been reduced with the adoption of new technologies.
- Newly developed noise filter (EMC filter)**
  - Because of the built-in EMC filter, the inverter itself can comply with the EMC Directive (2nd environment\*1) by setting the connector to "with filter"(\*2,\*3).

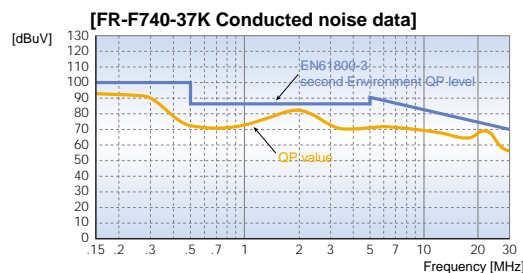

\*1: Refer to the EMC instruction manual for compliance conditions.  
 \*2: Leakage current will increase when the EMC filter is selected.  
 \*3: Since the leakage current when using the EMC filter for the 200V class 0.75K and 1.5K is small, the filter is always valid (a setting connector is not provided).

- Because of the built-in capacitive filter and zero-phase reactor (55K or less), connecting the optional DC reactor to the inverter will comply with the electric installation work common specification and machine installation work common specification (2001) written under the general editorship of the Japanese Ministry of land, infrastructure and transportation.

	Capacitive filter	Zero-phase reactor	DC reactor
55K or less	Standard (Built-in)	Standard (Built-in)	Option (Sell separately)
75K or more	Standard (Built-in)	Option (Sell separately)	Standard (supplied)

### (2) Countermeasures for harmonic current output

- Small AC reactor (FR-HAL)/DC reactor (FR-HEL)**
  - AC reactor and DC reactor options for the control of harmonics current output has been miniaturized.  
(DC reactor is supplied with the 75K or more as standard.)
- Connection with high power factor converter (FR-HC/MT-HC) is possible**
  - Connection is possible to high power-factor converter for effective suppressions of power-supply harmonics (coefficient K5=0).

### (3) Equipped with inrush current limit circuit

- Because of the built-in inrush current limit circuit, the current at power on is restricted.

## 5. Simple Operation

### (1) Equipped with operation panel with the popular setting dial **A**

- Operation is easy with the popular setting dial.
  - Frequency and parameters can be set without frustrations.
  - Settings can be made quickly or slowly depending on fast the dial is being turned.
  - Settings are certain due to the "clicking" sensation and notch on dial.



- Operation panel is detachable and can be installed on the front cover. (Cable connector option is required.)
- PU/EXT (operation mode) switchover key is available.
- Dial/key operation lock function is available.



### (2) FR Configurator (setup software)

- From start up to maintenance of the inverter is simple.
- Possible to save and print parameter setting file making parameter management simple  
(Possible to use communications connecting to any of PU connector and RS-485 terminals)



## 6. Enhanced Network

### (1) RS-485 terminal is standard equipped **G H**

- RS-485 terminals are available in addition to the PU connector. RS-485 communication can be performed using the operation panel or parameter unit. Since terminals for input and output are provided separately, multi-drop connection is easily done.
- Modbus-RTU (Binary) protocol has been added for communications in addition to computer link.

### (2) Possible to correspond with major networks

- Possible to connect with LonWorks, CC-Link Ver.1.1 and Ver.2.0, DeviceNet™ and Profibus-DP when used with communication options

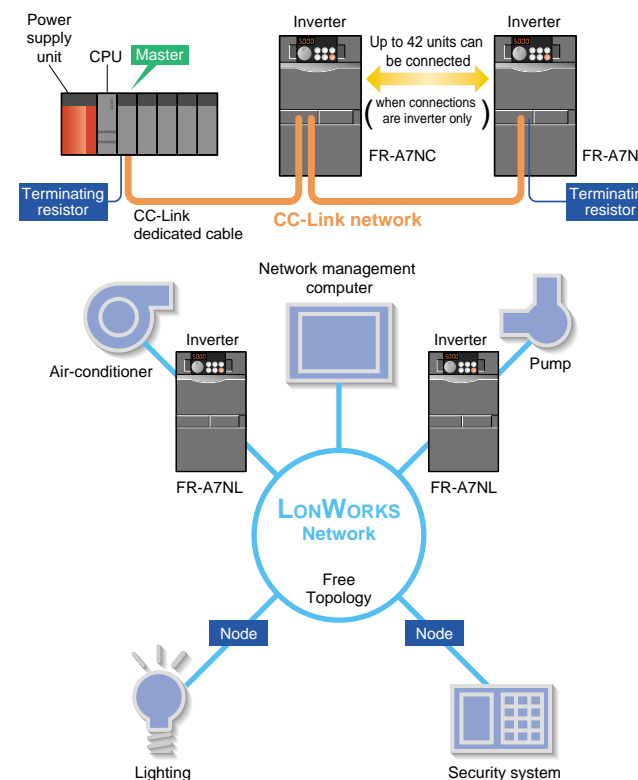

## 7. Global Compliance

### (1) Complies with UL, cUL, EN (LVD) standards



### (2) Possible to switch sink/source with one-touch

- Possible to switch the logic of I/O terminals. Possible to use in all regions

### (3) Wide voltage range

- Accommodate both 240V power supply (55K or less) and 480V power supply as standard

## 8. Wide Range of Functions

### (1) Remote output function

- You can utilize the on/off of the inverter's output signals instead of the remote output function of the programmable logic controller.

### (2) Enhanced I/O is standard

- 12 contact inputs, 3 analog inputs, 5 open collector outputs, 2 relay outputs, analog output and pulse output are all standard.
- Possible to assign variety of functions to contact inputs, open collector outputs and relay outputs
- Possible to switch between voltage and current for the analog input.
- Possible to display the ON/OFF status of the I/O terminals on the operation panel

### (3) Simple magnetic flux vector control is possible

- High torque in low speed region is possible with simple magnetic flux vector control  
(120% torque is possible at 3Hz with slip compensation)

	V/F + Optimum Excitation	Simple Magnetic Flux Vector
For torque	—	◎
For energy savings	◎	—

## LINE UP



**FR-F720-0.75K**

Symbol	Voltage	Symbol	Inverter Capacity
2	200V class	0.75K to 560K	Indicate capacity (kW)
4	400V class		

Applied Motor (kW)	Three-phase 200V class		Three-phase 400V class	
	FR-F720-□□	FR-F740-□□	FR-F720-□□	FR-F740-□□
0.75	●	●	●	●
1.5	●	●	●	●
2.2	●	●	●	●
3.7	●	●	●	●
5.5	●	●	●	●
7.5	●	●	●	●
11	●	●	●	●
15	●	●	●	●
18.5	●	●	●	●
22	●	●	●	●
30	●	●	●	●
37	●	●	●	●
45	●	●	●	●
55	●	●	●	●

●: Available models —: Not available

# Connection with Peripheral Devices

Peripheral devices necessary for driving the FR-F700 series inverter are indicated below.



**Three-phase AC power supply**  
Use within the permissible power supply specifications of the inverter. (Refer to page 7.)

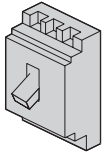

**Moulded case circuit breaker (MCCB) or earth leakage circuit breaker (ELB), fuse**  
The breaker must be selected carefully since an in-rush current flows in the inverter at power on. (Refer to page 57.)

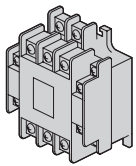

**Magnetic contactor (MC)**  
Install the magnetic contactor to ensure safety. Do not use this magnetic contactor to start and stop the inverter. Doing so will cause the inverter life to be shorten. (Refer to page 57.)



**Reactor (FR-HAL, FR-HEL)**  
Reactors (option) should be used when power harmonics measures are taken, the power factor is to be improved or the inverter is installed near a large power supply system (1000kVA or more). The inverter may be damaged if you do not use reactors. Select the reactor according to the model. For the 55K or less, remove the jumpers across terminals P/+ - P1 to connect to the DC reactor. (Refer to page 51.)

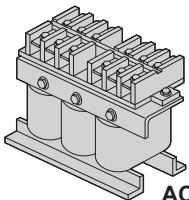

**AC reactor (FR-HAL)**  
(Refer to page 51.)

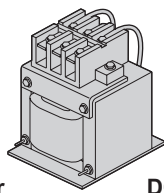

**DC reactor (FR-HEL)**  
For the 75K or more, a DC reactor is supplied. Always install the reactor. (Refer to page 51.)

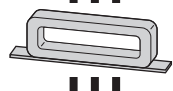

**Noise filter (FR-BLF)**  
It is not necessary for the 55K or less.



**PLC**  
**RS-485 terminal block**  
The inverter can be connected with computers such as PLC. It supports Mitsubishi inverter protocol and Modbus-RTU (binary) protocol.



**Inverter (FR-F700)**

The life of the inverter is influenced by ambient temperature. The ambient temperature should be as low as possible within the permissible range. (Refer to page 8.) This must be noted especially when the inverter is installed in an enclosure. Wrong wiring might lead to damage of the inverter. The control signal lines must be kept fully away from the main circuit to protect them from noise.

P/+ P1 R/L1 S/L2 T/L3 P/+ N/-

Earth (Ground)

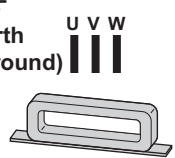

**Noise filter (FR-BSF01, FR-BLF)**  
Install a noise filter to reduce the electromagnetic noise generated from the inverter. Effective in the range from about 1MHz to 10MHz. When more wires are passed through, a more effective result can be obtained.

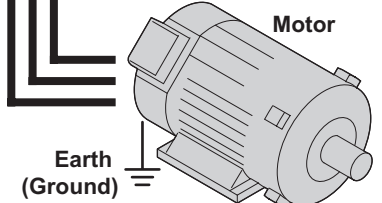

Earth (Ground)

**Devices connected to the output**

Do not install a power factor correction capacitor, surge suppressor or radio noise filter on the output side of the inverter.

When installing a moulded case circuit breaker on the output side of the inverter, contact each manufacturer for selection of the moulded case circuit breaker.

**Earth (Ground)**

To prevent an electric shock, always earth (ground) the motor and inverter.

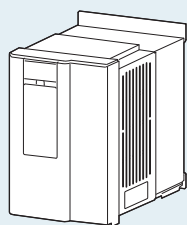

**High power factor converter (FR-HC\*1, MT-HC\*2)**  
Power supply harmonics can be greatly suppressed. Install this as required.

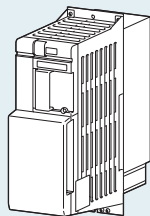

**Power regeneration common converter (FR-CV\*1) Power regeneration converter (MT-RC\*2)**  
Greater braking capability is obtained. Install this as required.

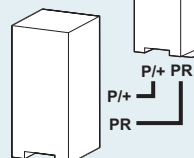

**Resistor unit (FR-BR\*1, MT-BR5\*2)**  
The regenerative braking capability of the inverter can be exhibited fully. Install this as required.

**Brake unit (FR-BU\*1, MT-BU5\*2)**

\*1 Compatible with the 55K or less.  
\*2 Compatible with the 75K or more.

Refer to page 49 for the option list and details.

# Why Can the Inverter Save Energy?

The load torque of a motor-driven machine generally changes depending on speed. On the other hand, motor output is proportional to the product of load torque and speed as indicated in the following formula, and therefore, necessary motor output varies with speed.

Motor output  $P = T \times N / (9550 \times \eta)$  [kW]  
 T : Motor shaft-equivalent load torque [N·m]  
 N : Motor speed [r/min]  
 $\eta$  : Machine efficiency

When this motor is operated by the inverter, the inverter output provides the frequency  $f$  appropriate to the motor speed, and the then output voltage  $V$  is determined by a " $V/f = \text{constant}$ " pattern in the case of a constant-torque load. For example, when the motor is operated at middle speed,  $f$ , i.e. output voltage  $V$ , decreases, and therefore, the inverter output power  $V \times I$  reduces if the output current  $I$  is constant.

Proportionately, the inverter input current decreases and the power consumption reduces. Namely, when the motor output reduces, the input power of the inverter also decreases as a matter of course.

The fundamental principle of energy saving by the inverter is to eliminate wasted power consumption by minimizing loss caused by the other devices and minimizing the motor output as compared to the other system (for example, commercial power supply operation or secondary resistance control of wound-rotor motor). A maximum energy saving effect is produced on a fan, pump or like by the variable-torque load characteristic that reduces load torque as speed decreases.

Motor speed control enables substantial energy-saving operation as compared to commercial power supply operation.

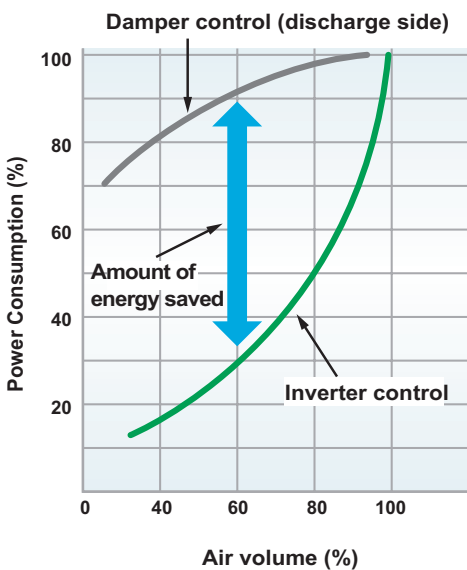

For example, when a 15kW motor is operated at 60% air volume and the power charge is 17 yen/kW·h, the power charge as much as below can be saved in a year.

- (1) Damper control  
 $15\text{kW} \times 0.9 \times 17 \text{ yen} \times 24\text{h} \times 365\text{days} \doteq 2.01 \text{ million yen}$
- (2) Inverter control  
 $15\text{kW} \times 0.3 \times 17 \text{ yen} \times 24\text{h} \times 365\text{days} \doteq 0.67 \text{ million yen}$

**(1) - (2) = energy-saving effect  
 Approx. 1.34 million yen**

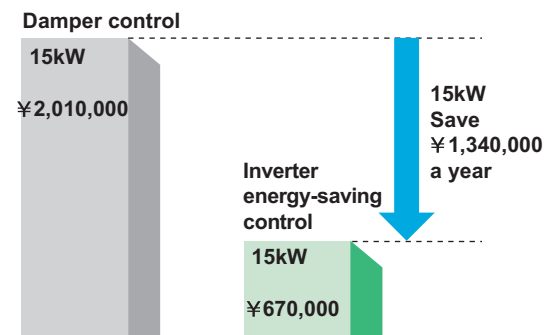

- Features
- Peripheral Devices Why energy savings?
- Standard Specifications
- Outline Dimension Drawings
- Terminal Connection Diagram Terminal Specification Explanation
- Operation Panel
- Parameter List
- Explanation of Parameters
- Protective Functions
- Options
- Instructions
- Motor
- Compatibility
- Warranty
- Inquiry

# Standard Specifications

## ● Rating

### ●200V class

Type FR-F720-□□K		0.75	1.5	2.2	3.7	5.5	7.5	11	15	18.5	22	30	37	45	55	75	90	110
Applied motor capacity (kW) <sup>*1</sup>		0.75	1.5	2.2	3.7	5.5	7.5	11	15	18.5	22	30	37	45	55	75	90	110
Output	Rated capacity (kVA) <sup>*2</sup>	1.6	2.7	3.7	5.8	8.8	11.8	17.1	22.1	27	32	43	53	65	81	110	132	165
	Rated current (A) <sup>*3</sup>	4.2 (3.6)	7.0 (6.0)	9.6 (8.2)	15.2 (13)	23 (20)	31 (26)	45 (38)	58 (49)	70 (60)	85 (72)	114 (97)	140 (119)	170 (145)	212 (180)	288 (244)	346 (294)	432 (367)
	Overload current rating <sup>*4</sup>	120% 60s, 150% 3s (inverse time characteristics)																
	Voltage <sup>*5</sup>	Three-phase 200 to 240V																
Power supply	Rated input AC voltage/frequency	Three-phase 200 to 220V 50Hz, 200 to 240V 60Hz																
	Permissible AC voltage fluctuation	170 to 242V 50Hz, 170 to 264V 60Hz																
	Permissible frequency fluctuation	±5%																
	Power supply system capacity (kVA) <sup>*6</sup>	2.5	4.5	5.5	9	12	17	20	28	34	41	52	65	79	99	110	132	165
Protective structure (JEM 1030) <sup>*8</sup>	Enclosed type (IP20) <sup>*7</sup>										Open type (IP00)							
Cooling system	Self-cooling			Forced air cooling														
Approx. mass (kg)	1.8	2.2	3.5	3.5	3.5	6.5	6.5	7.5	13	13	14	23	35	35	67	70	70	

### ●400V class

Type FR-F740-□□K		0.75	1.5	2.2	3.7	5.5	7.5	11	15	18.5	22	30	37	45	55
Applied motor capacity (kW) <sup>*1</sup>		0.75	1.5	2.2	3.7	5.5	7.5	11	15	18.5	22	30	37	45	55
Output	Rated capacity (kVA) <sup>*2</sup>	1.6	2.7	3.7	5.8	8.8	12.2	17.5	22.1	26.7	32.8	43.4	53.3	64.8	80.8
	Rated current (A) <sup>*3</sup>	2.1 (1.8)	3.5 (3.0)	4.8 (4.1)	7.6 (6.4)	11.5 (9.8)	16 (13)	23 (19)	29 (24)	35 (30)	43 (36)	57 (48)	70 (60)	85 (72)	106 (90)
	Overload current rating <sup>*4</sup>	120% 60s, 150% 3s (inverse time characteristics)													
	Voltage <sup>*5</sup>	Three-phase 380 to 480V													
Power supply	Rated input AC voltage/frequency	Three-phase 380 to 480V 50Hz/60Hz													
	Permissible AC voltage fluctuation	323 to 528V 50Hz/60Hz													
	Permissible frequency fluctuation	±5%													
	Power supply system capacity (kVA) <sup>*6</sup>	2.5	4.5	5.5	9	12	17	20	28	34	41	52	66	80	100
Protective structure (JEM 1030) <sup>*8</sup>	Enclosed type (IP20) <sup>*7</sup>											Open type (IP00)			
Cooling system	Self-cooling				Forced air cooling										
Approx. mass (kg)	3.5	3.5	3.5	3.5	3.5	6.5	6.5	7.5	7.5	13	13	23	35	35	

Type FR-F740-□□K		75	90	110	132	160	185	220	250	280	315	355	400	450	500	560
Applied motor capacity (kW) <sup>*1</sup>		75	90	110	132	160	185	220	250	280	315	355	400	450	500	560
Output	Rated capacity (kVA) <sup>*2</sup>	110	137	165	198	247	275	329	366	416	464	520	586	659	733	833
	Rated current (A) <sup>*3</sup>	144 (122)	180 (153)	216 (183)	260 (221)	325 (276)	361 (306)	432 (367)	481 (408)	547 (464)	610 (518)	683 (580)	770 (654)	866 (736)	962 (817)	1094 (929)
	Overload current rating <sup>*4</sup>	120% 60s, 150% 3s (inverse time characteristics)														
	Voltage <sup>*5</sup>	Three-phase 380 to 480V														
Power supply	Rated input AC voltage/frequency	Three-phase 380 to 480V 50Hz/60Hz														
	Permissible AC voltage fluctuation	323 to 528V 50Hz/60Hz														
	Permissible frequency fluctuation	±5%														
	Power supply system capacity (kVA) <sup>*6</sup>	110	137	165	198	247	275	329	366	416	464	520	586	659	733	833
Protective structure (JEM 1030) <sup>*8</sup>	Open type (IP00)															
Cooling system	Forced air cooling															
Approx. mass (kg)	37	50	57	72	72	110	110	175	175	175	260	260	370	370	370	

- \*1. The applied motor capacity indicated is the maximum capacity applicable for use of the Mitsubishi 4-pole standard motor.
- \*2. The rated output capacity indicated assumes that the output voltage is 220V for 200V class and 440V for 400V class.
- \*3. When operating the inverter with the carrier frequency set to 3kHz or more, the carrier frequency automatically decreases if the inverter output current exceeds the value in parenthesis of the rated current. This may cause the motor noise to increase.
- \*4. The % value of the overload current rating indicated is the ratio of the overload current to the inverter's rated output current. For repeated duty, allow time for the inverter and motor to return to or below the temperatures under 100% load.
- \*5. The maximum output voltage does not exceed the power supply voltage. The maximum output voltage can be changed within the setting range. However, the pulse voltage value of the inverter output side voltage remains unchanged at about  $\sqrt{2}$  that of the power supply.
- \*6. The power supply capacity varies with the value of the power supply side inverter impedance (including those of the input reactor and cables).
- \*7. When the hook of the inverter front cover is cut off for installation of the plug-in option, the inverter changes to an open type (IP00).
- \*8. FR-DU07 : IP40 (Except for the PU connector).

● Common specifications

Control specifications	Control system		High carrier frequency PWM control (V/F control)/optimum excitation control/simple magnetic flux vector control		
	Output frequency range		0.5 to 400Hz		
	Frequency setting resolution	Analog input	0.015Hz/0 to 60Hz (terminal 2, 4: 0 to 10V/12bit) 0.03Hz/0 to 60Hz (terminal 2, 4: 0 to 5V/11bit, 0 to 20mA/11bit, terminal 1: 0 to ±10V/12bit) 0.06Hz/0 to 60Hz (terminal 1: 0 to ±5V/11bit)		
		Digital input	0.01Hz		
	Frequency accuracy	Analog input	Within ±0.2% of the max. output frequency (25°C ± 10°C)		
		Digital input	Within 0.01% of the set output frequency		
	Voltage/frequency characteristics		Base frequency can be set from 0 to 400Hz Constant torque/variable torque pattern or adjustable 5 points V/F can be selected		
	Starting torque		120% (3Hz) when set to simple magnetic flux vector control and slip compensation		
	Acceleration/deceleration time setting		0 to 3600s (acceleration and deceleration can be set individually), linear or S-pattern acceleration/deceleration mode can be selected.		
	DC injection brake		Operation frequency (0 to 120Hz), operation time (0 to 10s), operation voltage (0 to 30%) variable		
Stall prevention operation level		Operation current level can be set (0 to 150% adjustable), whether to use the function or not can be selected			
Operation specifications	Frequency setting signal	Analog input	Terminal 2, 4: 0 to 10V, 0 to 5V, 4 to 20mA can be selected Terminal 1: -10 to +10V, -5 to 5V can be selected		
		Digital input	Four-digit BCD or 16-bit binary using the setting dial of the operation panel (when used with the option FR-A7AX)		
	Start signal		Available individually for forward rotation and reverse rotation. Start signal automatic self-holding input (3-wire input) can be selected.		
	Input signals		You can select any twelve signals using Pr.178 to Pr.189 (input terminal function selection) from among multi speed selection, second function selection, terminal 4 input selection, JOG operation selection, selection of automatic restart after instantaneous power failure, external thermal relay input, HC connection (inverter operation enable signal), HC connection (instantaneous power failure detection), PU operation/external inter lock signal, PID control enable terminal, PU operation, external operation switchover, output stop, start self-holding selection, forward rotation command, reverse rotation command, inverter reset, PTC thermistor input, PID forward reverse operation switchover, PU-NET operation switchover, NET-external operation switchover, command source switchover.		
	Operational functions		Maximum and minimum frequency settings, frequency jump operation, external thermal relay input selection, polarity reversible operation, automatic restart after instantaneous power failure operation, original operation continuation at instantaneous power failure, commercial power supply-inverter switchover operation, forward/reverse rotation prevention, operation mode selection, PID control, computer link operation (RS-485).		
	Output signals	Operating status		You can select any seven signals using Pr.190 to Pr.196 (output terminal function selection) from among inverter running, up-to-speed, instantaneous power failure /undervoltage, overload warning, output frequency detection, second output frequency detection, regenerative brake prealarm <sup>*4</sup> , electronic thermal relay function pre-alarm, PU operation mode, inverter operation ready, output current detection, zero current detection, PID lower limit, PID upper limit, PID forward rotation reverse rotation output, commercial power supply-inverter switchover MC1, commercial power supply-inverter switchover MC2, commercial power supply-inverter switchover MC3, fan fault output, heatsink overheat pre-alarm, inverter running start command on, deceleration at an instantaneous power failure, PID control activated, during retry, during PID output suspension, life alarm, alarm output 3 (power-off signal), power savings average value update timing, current average monitor, alarm output 2, maintenance timer alarm, remote output, minor failure output, alarm output. Open collector output (5 points), relay output (2 points) and alarm code of the inverter can be output (4 bit) from the open collector.	
		When used with the FR-A7AY, FR-A7AR (option)		You can select any seven signals using Pr.313 to Pr. 319 (extension output terminal function selection) from among control circuit capacitor life, main circuit capacitor life, cooling fan life, inrush current limit circuit life and the above stated signals. (Only positive logic can be set for terminals of the FR-A7AR.)	
		Pulse/analog output		Selection can be made from output frequency, motor current (steady or peak value), output voltage, frequency setting value, running speed, converter output voltage (steady or peak value), electronic thermal relay function load factor, input power, output power, load meter, reference voltage output, motor load factor, power saving effect, regenerative brake duty <sup>*4</sup> , PID set value, PID measured value using Pr.54 "FM terminal function selection (pulse train output)" and Pr.158 "AM terminal function selection (analog output)".	
	Display	PU (FR-DU07/FR-PU04)	Operating status		Output frequency, motor current (steady or peak value), output voltage, frequency setting, running speed, converter output voltage (steady or peak value), electronic thermal relay function load factor, input power, output power, load meter, cumulative energization time, actual operation time, motor load factor, cumulative energization power, power saving effect, cumulative saving power, regenerative brake duty <sup>*4</sup> , PID set point, PID measured value, PID deviation value, inverter I/O terminal monitor, input terminal option monitor <sup>*1</sup> , output terminal option monitor <sup>*1</sup> , option fitting status monitor <sup>*2</sup> , terminal assignment status <sup>*2</sup>
			Alarm definition		Alarm definition is displayed when the protective function is activated, the output voltage/current/frequency/cumulative energization time right before the protection function was activated and the past 8 alarm definitions are stored
Interactive guidance			Operation guide/trouble shooting with a help function <sup>*2</sup>		
Protective/warning function		Overcurrent during acceleration, overcurrent during constant speed, overcurrent during deceleration, overvoltage during acceleration, overvoltage during constant speed, overvoltage during deceleration, inverter protection thermal operation, motor protection thermal operation, heatsink overheat, instantaneous power failure occurrence, undervoltage, input phase failure, motor overload, output side earth (ground) fault overcurrent, output phase failure, external thermal relay operation, PTC thermistor operation, option alarm, parameter error, PU disconnection, retry count excess, CPU alarm, operation panel power supply short circuit, 24VDC power output short circuit, output current detection value excess, inrush resistance overheat, communication alarm (inverter), analog input alarm, internal circuit alarm (15V power supply), fan fault, overcurrent stall prevention, overvoltage stall prevention, electronic thermal relay function prealarm, PU stop, maintenance timer alarm <sup>*1</sup> , brake transistor alarm <sup>*4</sup> , parameter write error, copy operation error, operation panel lock, parameter copy alarm			
Environment	Ambient temperature		-10°C to +50°C (non-freezing)		
	Ambient humidity		90%RH or less (non-condensing)		
	Storage temperature <sup>*3</sup>		-20°C to +65°C		
	Atmosphere		Indoors (without corrosive gas, flammable gas, oil mist, dust and dirt etc.)		
	Altitude, vibration		Maximum 1000m above seal level, 5.9m/s <sup>2</sup> or less at 10 to 55Hz (directions of X, Y, Z axes) <sup>*5</sup>		

\*1. Can be displayed only on the operation panel (FR-DU07).

\*2. Can be displayed only on the parameter unit (FR-PU04).

\*3. Temperature applicable for a short period in transit, etc.

\*4. Only the 75K or more functions.

\*5. 2.9m/s<sup>2</sup> or less for the 185K or more.

Features

Peripheral Devices Why energy savings?

Standard Specifications

Outline Dimension Drawings

Terminal Connection Diagram Terminal Specification Explanation

Operation Panel

Parameter List

Explanations of Parameters

Protective Functions

Options

Instructions

Motor

Compatibility

Warranty

Inquiry

# Outline Dimension Drawings

- FR-F720-0.75K, 1.5K

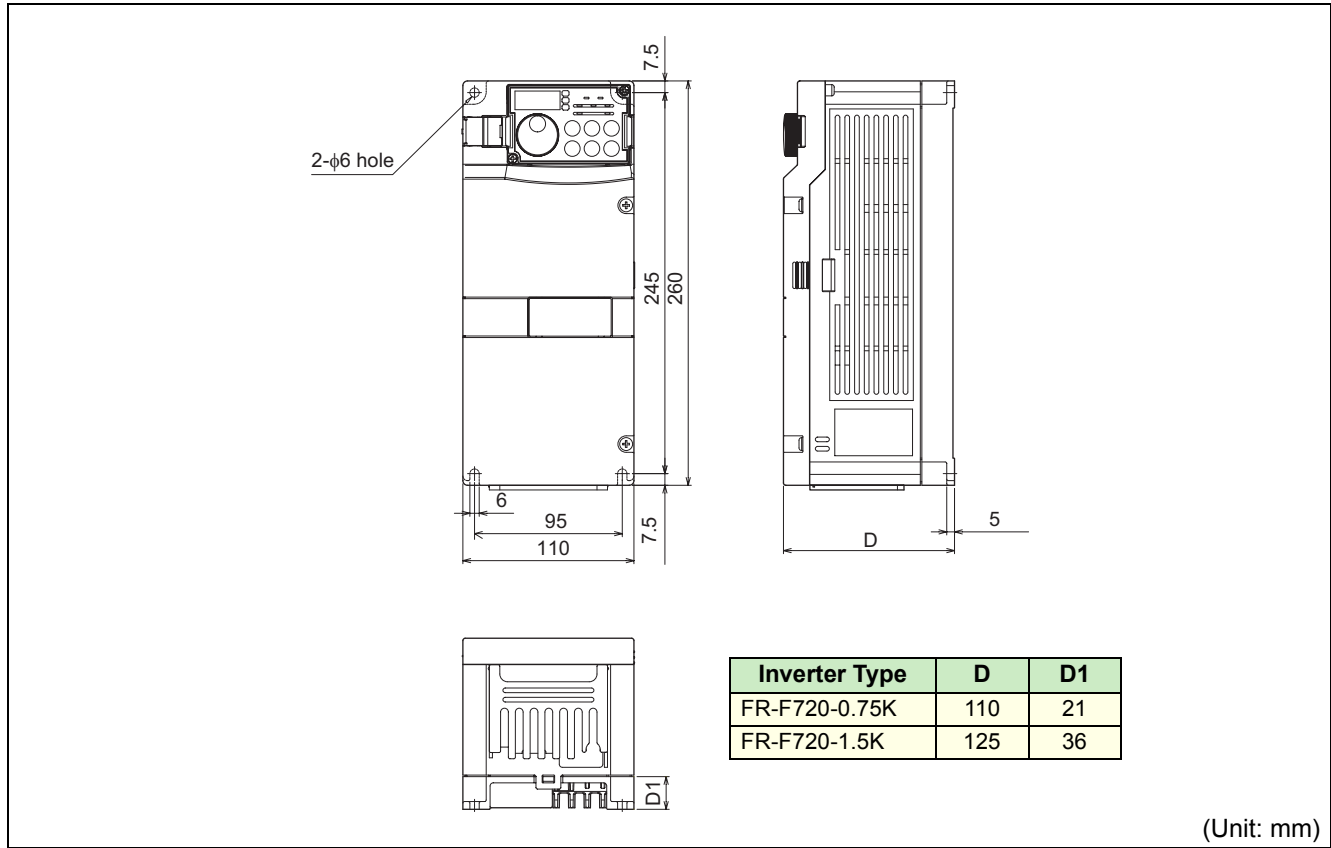

- FR-F720-2.2K, 3.7K, 5.5K
- FR-F740-0.75K, 1.5K, 2.2K, 3.7K, 5.5K

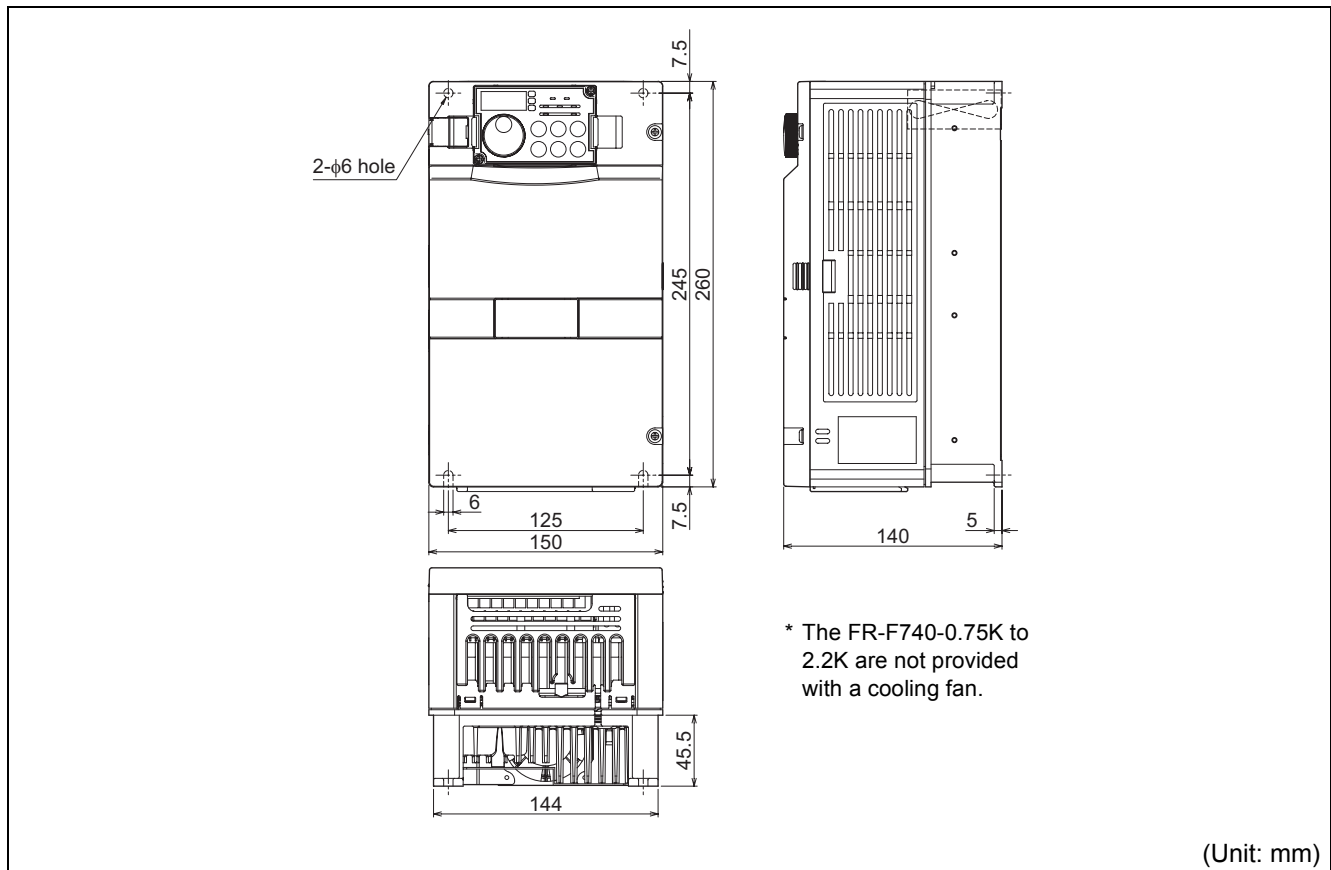



- FR-F720-7.5K, 11K, 15K
- FR-F740-7.5K, 11K, 15K, 18.5K

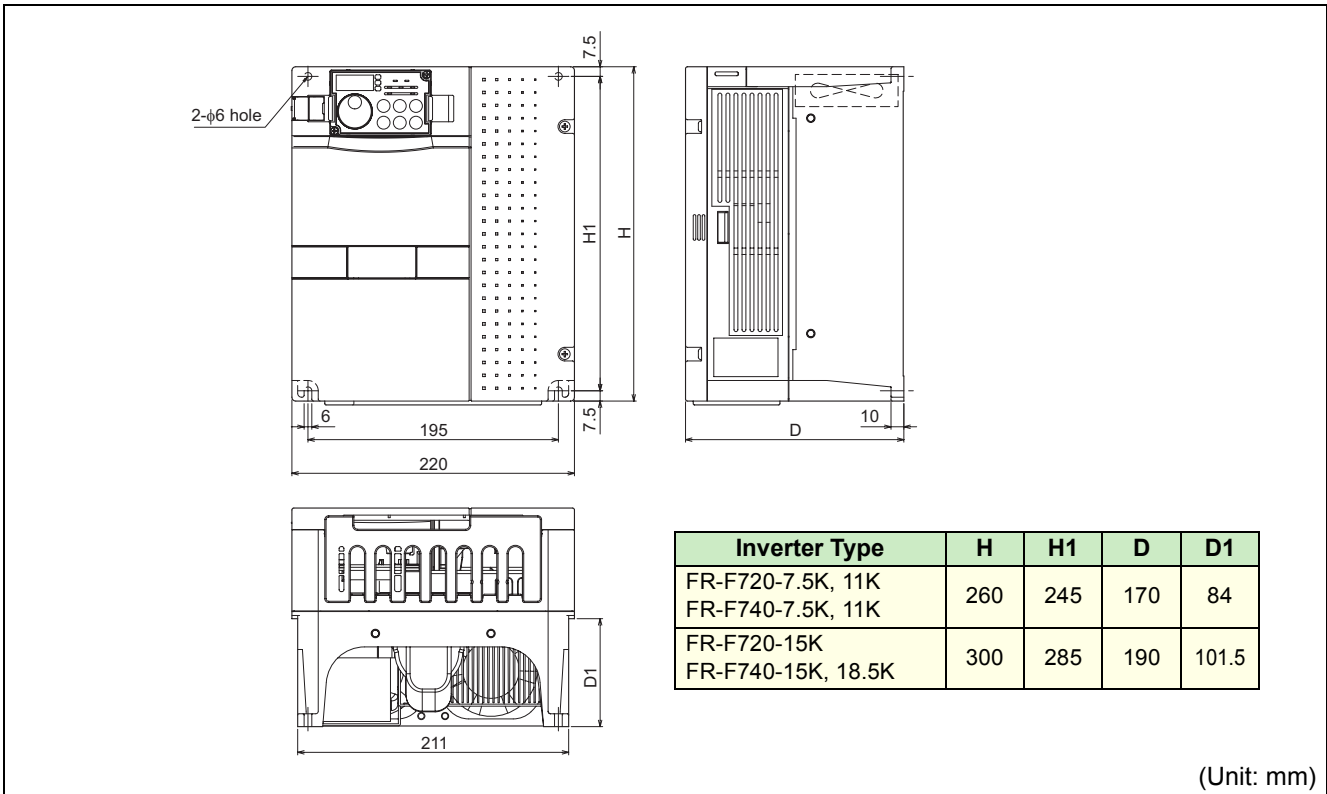

(Unit: mm)

- FR-F720-18.5K, 22K, 30K
- FR-F740-22K, 30K

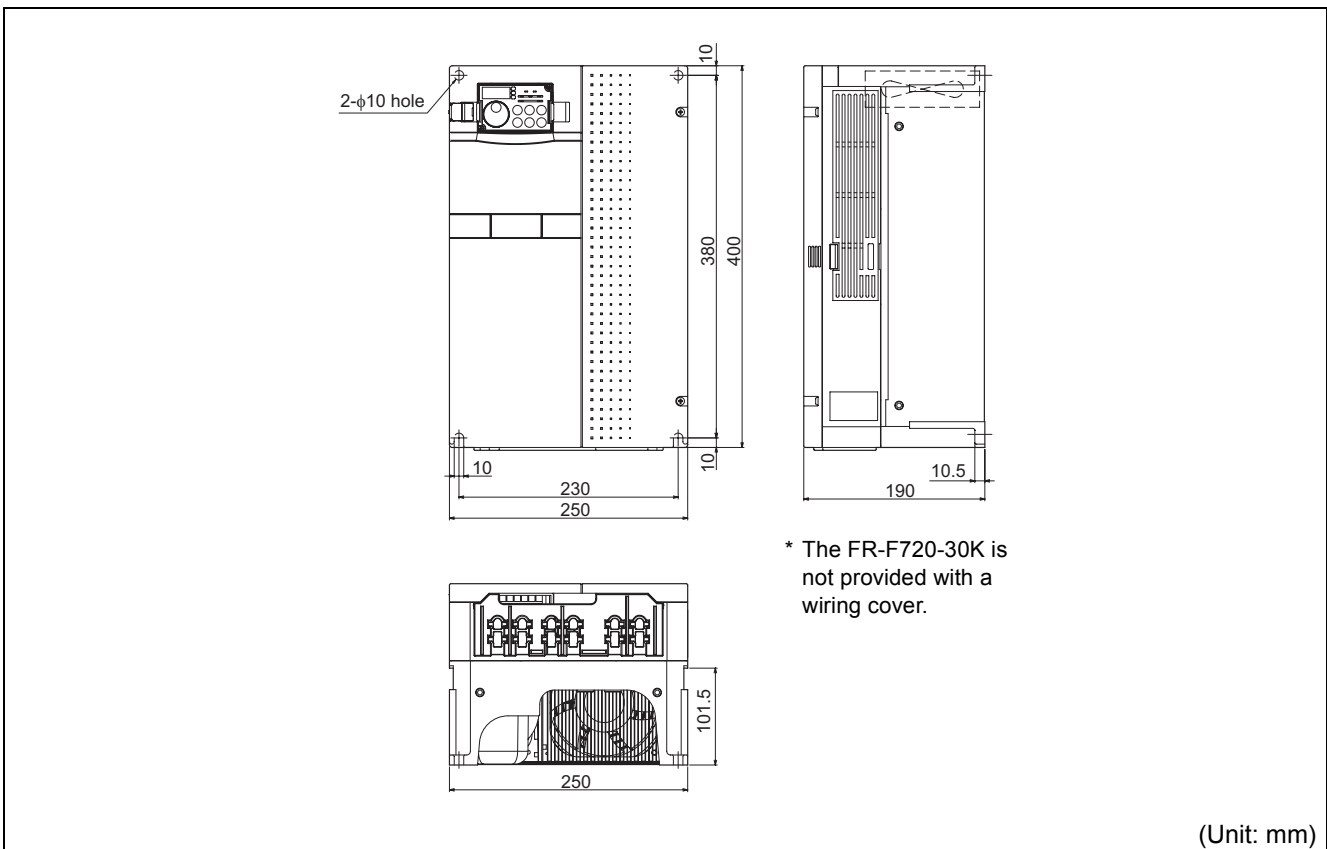

(Unit: mm)

- Features
- Peripheral Devices  
Why energy savings?
- Standard Specifications
- Outline Dimension Drawings
- Terminal Connection Diagram  
Terminal Specification Explanation
- Operation Panel
- Parameter List
- Explanations of Parameters
- Protective Functions
- Options
- Instructions
- Motor
- Compatibility
- Warranty
- Inquiry

- FR-F720-37K, 45K, 55K
- FR-F740-37K, 45K, 55K

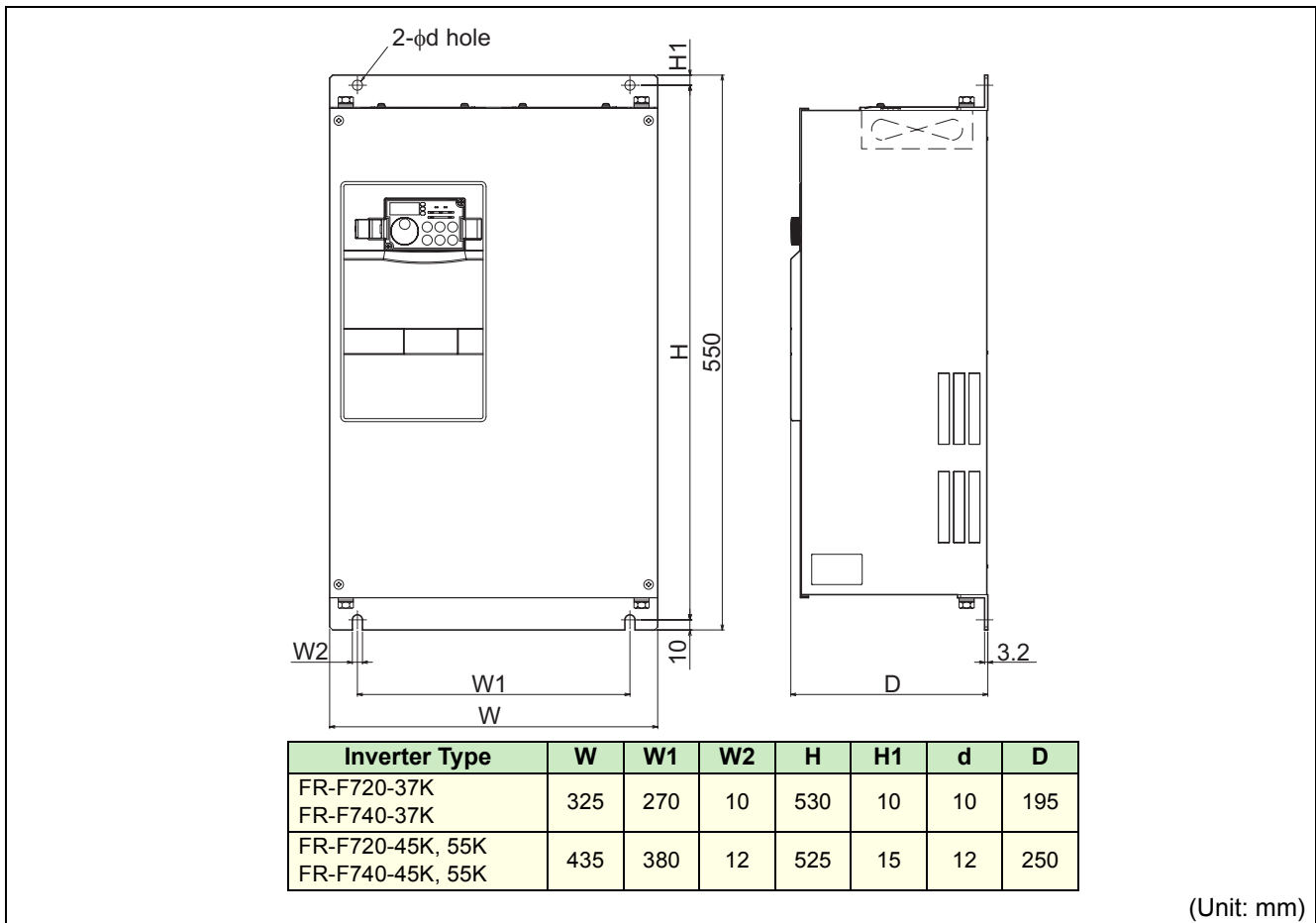

- FR-F740-75K, 90K

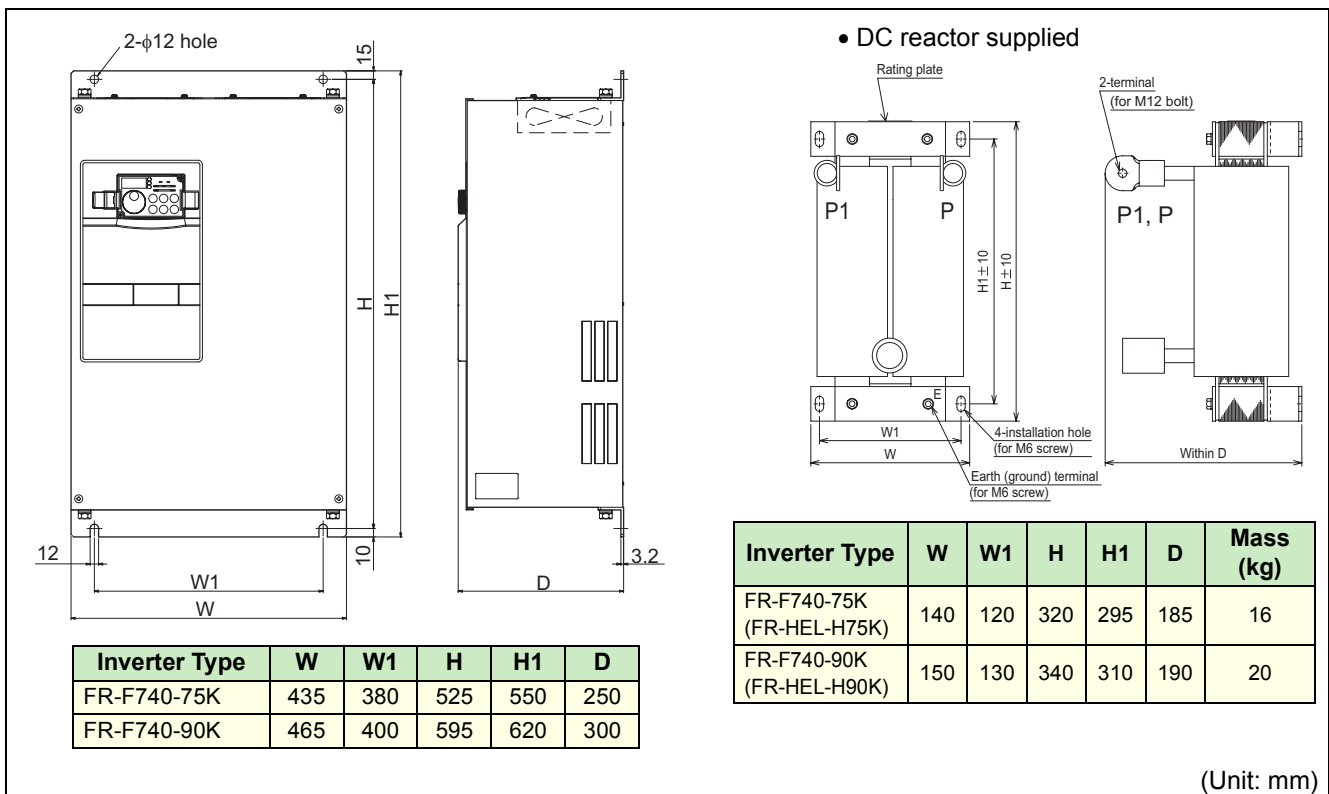

●FR-F740-110K

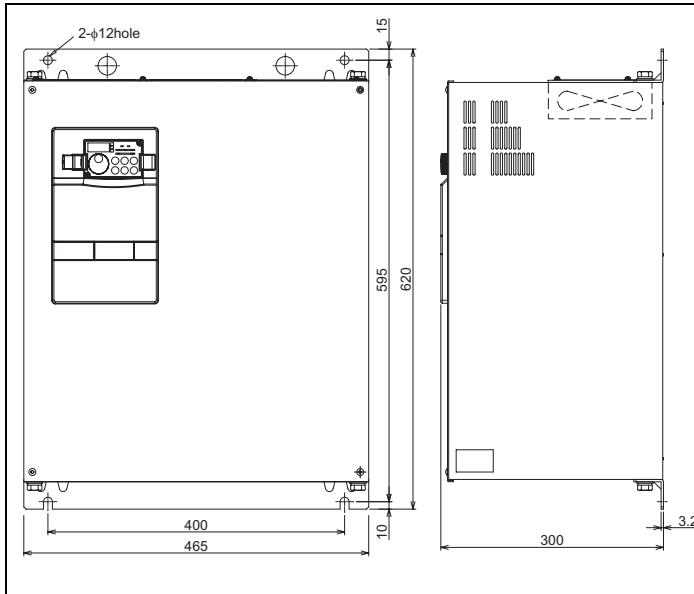

● DC reactor supplied

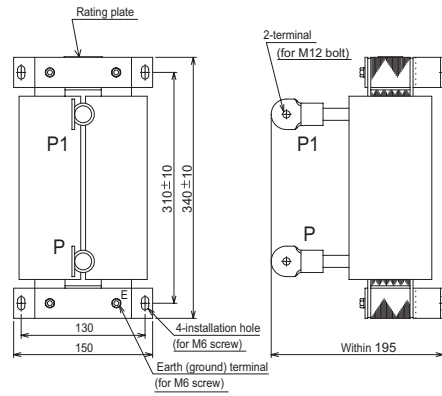

Inverter Type	Mass (kg)
FR-F740-110K(FR-HEL-H110K)	22

(Unit: mm)

- FR-F720-75K, 90K, 110K
- FR-F740-132K, 160K

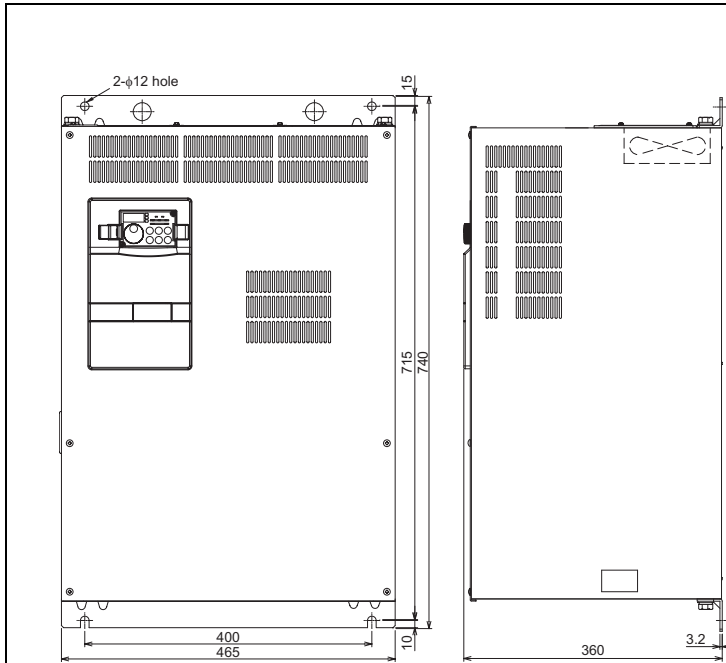

● DC reactor supplied

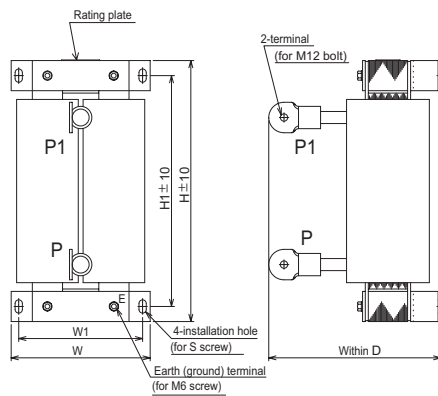

Inverter Type	W	W1	H	H1	D	S	Mass (kg)
FR-F720-75K(FR-HEL-75K)	150	130	340	310	190	M6	17
FR-F720-90K(FR-HEL-90K)	150	130	340	310	200	M6	19
FR-F720-110K(FR-HEL-110K)	175	150	400	365	200	M8	20
FR-F740-132K(FR-HEL-H132K)	175	150	405	370	200	M8	26
FR-F740-160K(FR-HEL-H160K)	175	150	405	370	205	M8	28

(Unit: mm)

- Features
- Peripheral Devices  
Why energy savings?
- Standard Specifications
- Outline Dimension Drawings
- Terminal Connection Diagram  
Terminal Specification Explanation
- Operation Panel
- Parameter List
- Explanations of Parameters
- Protective Functions
- Options
- Instructions
- Motor
- Compatibility
- Warranty
- Inquiry

● FR-F740-185K, 220K, 250K, 280K, 315K, 355K

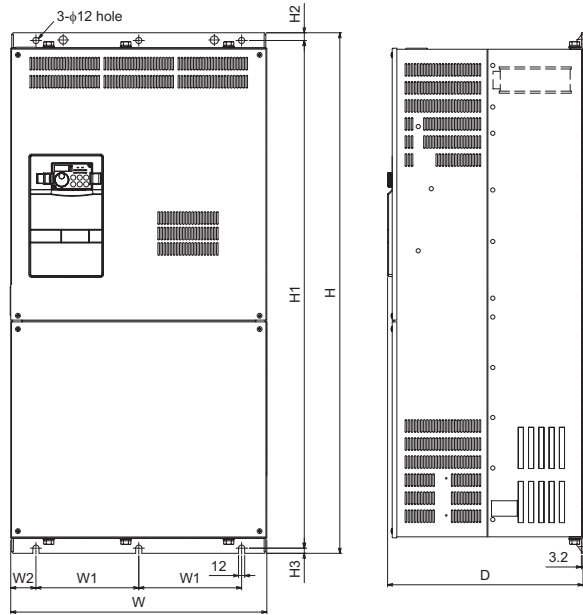

Inverter Type	W	W1	W2	H	H1	H2	H3	D
FR-F740-185K, 220K	498	200	49	1010	985	15	10	380
FR-F740-250K, 280K, 315K	680	300	40	1010	985	15	10	380
FR-F740-355K	790	315	80	1330	1300	15	15	440

● DC reactor supplied

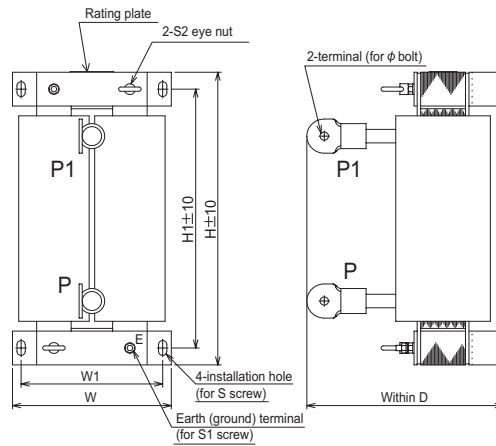

\* Remove the eye nut after installation of the product.

Inverter Type	W	W1	H	H1	D	S	S1	S2	φ	Mass (kg)
FR-F740-185K(FR-HEL-H185K)	175	150	405	370	240	M8	M6	—	M12	29
FR-F740-220K(FR-HEL-H220K)	175	150	405	370	240	M8	M6	M6	M12	30
FR-F740-250K(FR-HEL-H250K)	190	165	440	400	250	M8	M8	M8	M12	35
FR-F740-280K(FR-HEL-H280K)	190	165	440	400	255	M8	M8	M8	M16	38
FR-F740-315K(FR-HEL-H315K)	210	185	495	450	250	M10	M8	M8	M16	42
FR-F740-355K(FR-HEL-H355K)	210	185	495	450	250	M10	M8	M8	M16	46

(Unit: mm)

● FR-F740-400K

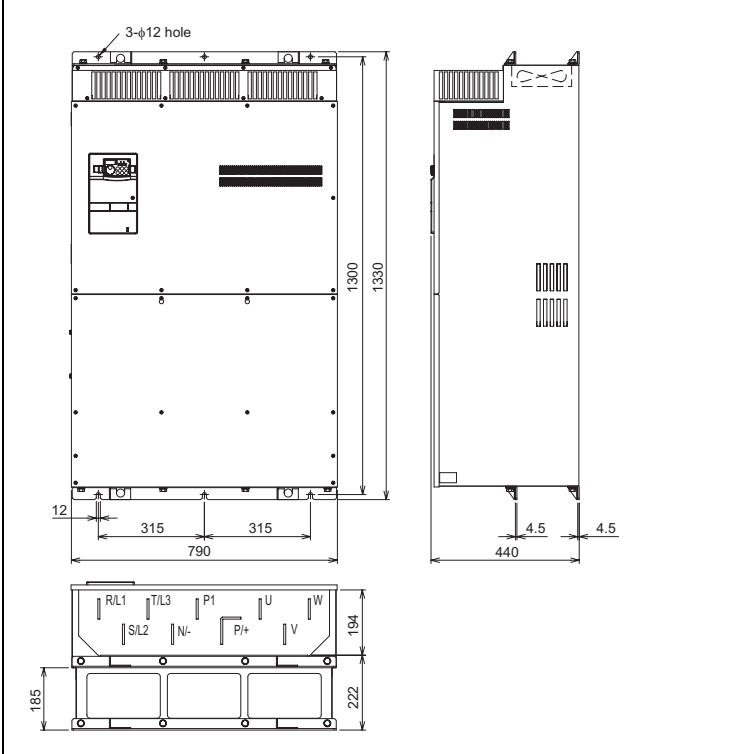

FR-F740-400K dimensions: Front view shows a width of 790mm (12mm offset, 315mm segments) and a height of 1330mm (1300mm main body, 30mm top). Side view shows a depth of 440mm. Bottom view shows a width of 790mm and a height of 222mm. Terminal block labels include RL1, T/L3, P1, U, W, S/L2, N1-, P/+, and V.

● DC reactor supplied

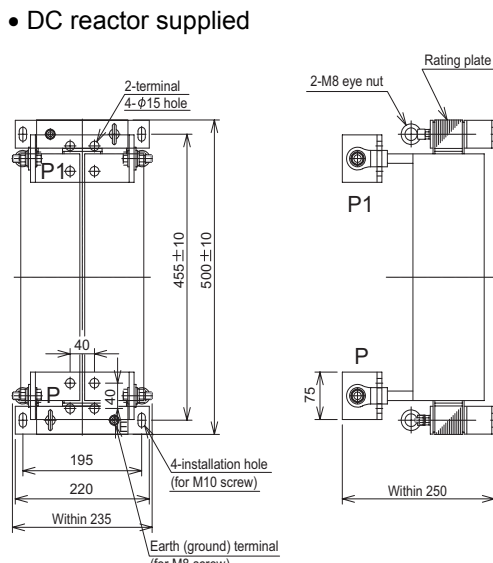

DC reactor connection diagrams show terminal specifications: 2-terminal, 4-φ15 hole, 455±10mm height, 500±10mm total height, 40mm width, 195mm and 220mm terminal spacing, 4-installation hole (for M10 screw), and Earth (ground) terminal (for M8 screw). The P1 terminal is connected to a 2-M8 eye nut and a Rating plate. The P terminal is connected to a Rating plate. The P1 terminal is 75mm high and within 250mm of the edge.

\* Remove the eye nut after installation of the product.

Inverter Type	Mass (kg)
FR-F740-400K(FR-HEL-H400K)	50

(Unit: mm)

● FR-F740-450K

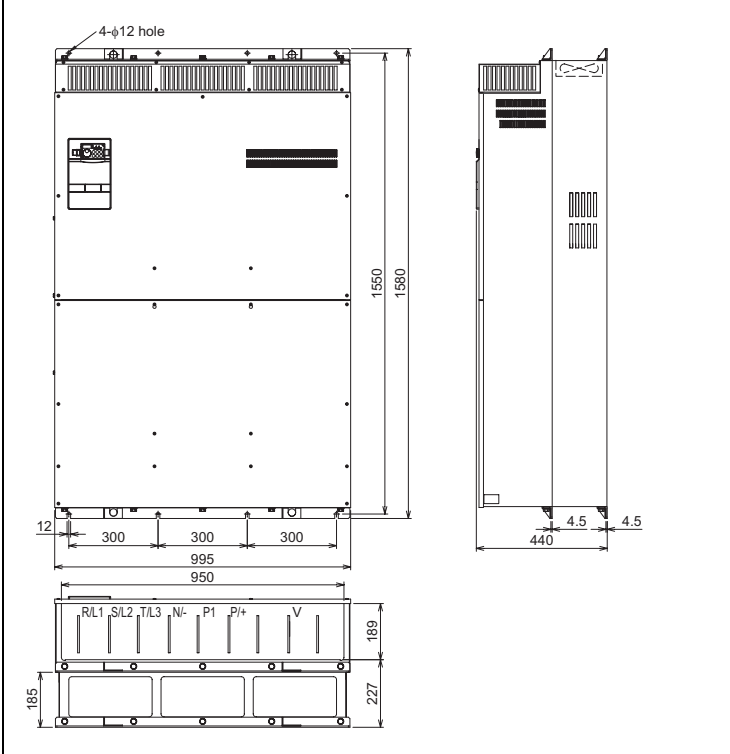

FR-F740-450K dimensions: Front view shows a width of 995mm (12mm offset, three 300mm segments) and a height of 1560mm (1550mm main body, 10mm top). Side view shows a depth of 440mm. Bottom view shows a width of 995mm and a height of 227mm. Terminal block labels include RL1, S/L2, T/L3, N1-, P1, P/+, and V.

● DC reactor supplied

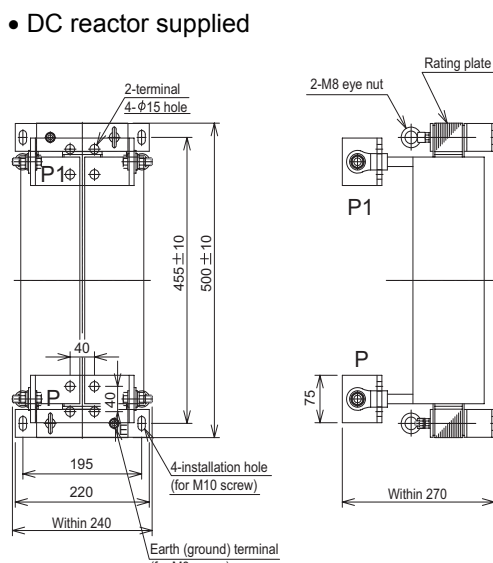

DC reactor connection diagrams show terminal specifications: 2-terminal, 4-φ15 hole, 455±10mm height, 500±10mm total height, 40mm width, 195mm and 220mm terminal spacing, 4-installation hole (for M10 screw), and Earth (ground) terminal (for M8 screw). The P1 terminal is connected to a 2-M8 eye nut and a Rating plate. The P terminal is connected to a Rating plate. The P1 terminal is 75mm high and within 270mm of the edge.

\* Remove the eye nut after installation of the product.

Inverter Type	Mass (kg)
FR-F740-450K(FR-HEL-H450K)	57

(Unit: mm)

- Features
- Peripheral Devices  
Why energy savings?
- Standard Specifications
- Outline Dimension Drawings
- Terminal Connection Diagram  
Terminal Specification Explanation
- Operation Panel
- Parameter List
- Explanations of Parameters
- Protective Functions
- Options
- Instructions
- Motor
- Compatibility
- Warranty
- Inquiry

● FR-F740-500K, 560K

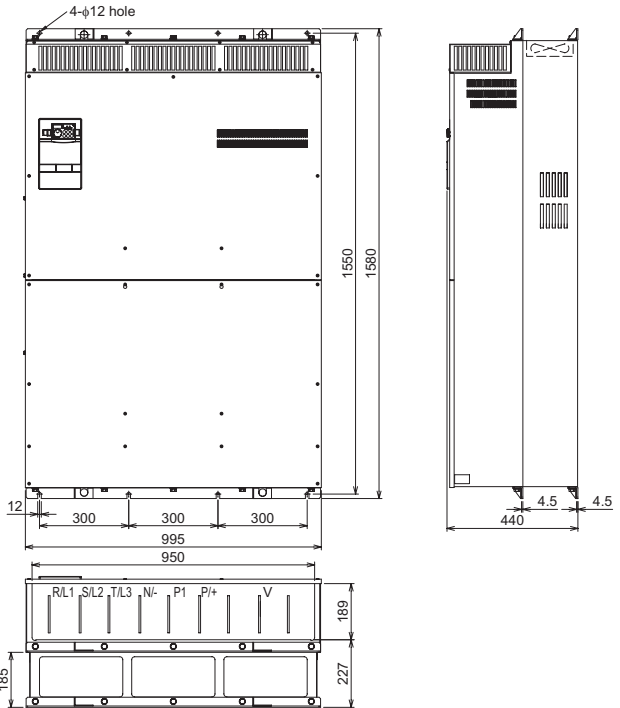

• DC reactor supplied

Rating plate  
2-terminal 4-φ15 hole  
Earth (ground) terminal (for M12 screw)  
\* Remove the eye nut after installation of the product.

Within 245  
40  
4.5  
4.5  
440  
Within H  
150  
215  
4-installation hole (for M10 screw)  
75  
D1 ± 10  
D ± 10

Inverter Type	H	D	D1	Mass (kg)
FR-F740-500K(FR-HEL-H500K)	345	455	405	67
FR-F740-560K(FR-HEL-H560K)	360	460	410	85

(Unit: mm)

● Operation panel (FR-DU07)

<Outline drawing>

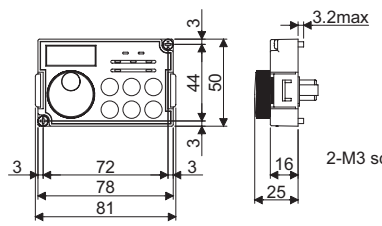

<Panel cutting dimension drawing>

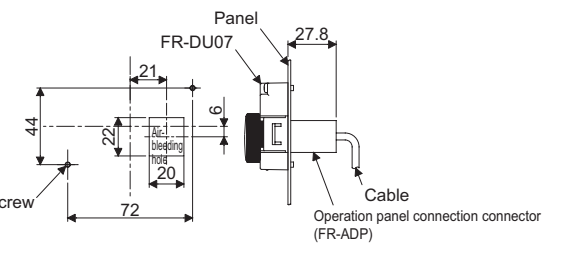

Panel FR-DU07  
27.8  
21  
44  
22  
20  
72  
6  
Cable  
Operation panel connection connector (FR-ADP)  
3.2max  
16  
25  
2-M3 screw

(Unit: mm)

● Parameter unit (option) (FR-PU04)

<Outline drawing>

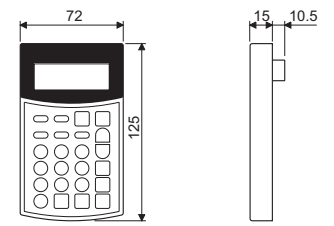

<Panel cutting dimension drawing>

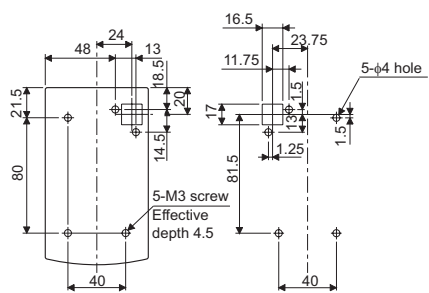

72  
125  
15  
10.5  
24  
48  
13  
16.5  
23.75  
11.75  
1.5  
5-φ4 hole  
1.25  
1.5  
80  
21.5  
14.5  
18.5  
20  
5-M3 screw Effective depth 4.5  
40  
40  
81.5

Select the installation screws whose length will not exceed the effective depth of the installation screws threads.

(Unit: mm)

# Terminal Connection Diagram

Sink logic  
 ◎ Main circuit terminal  
 ○ Control circuit terminal

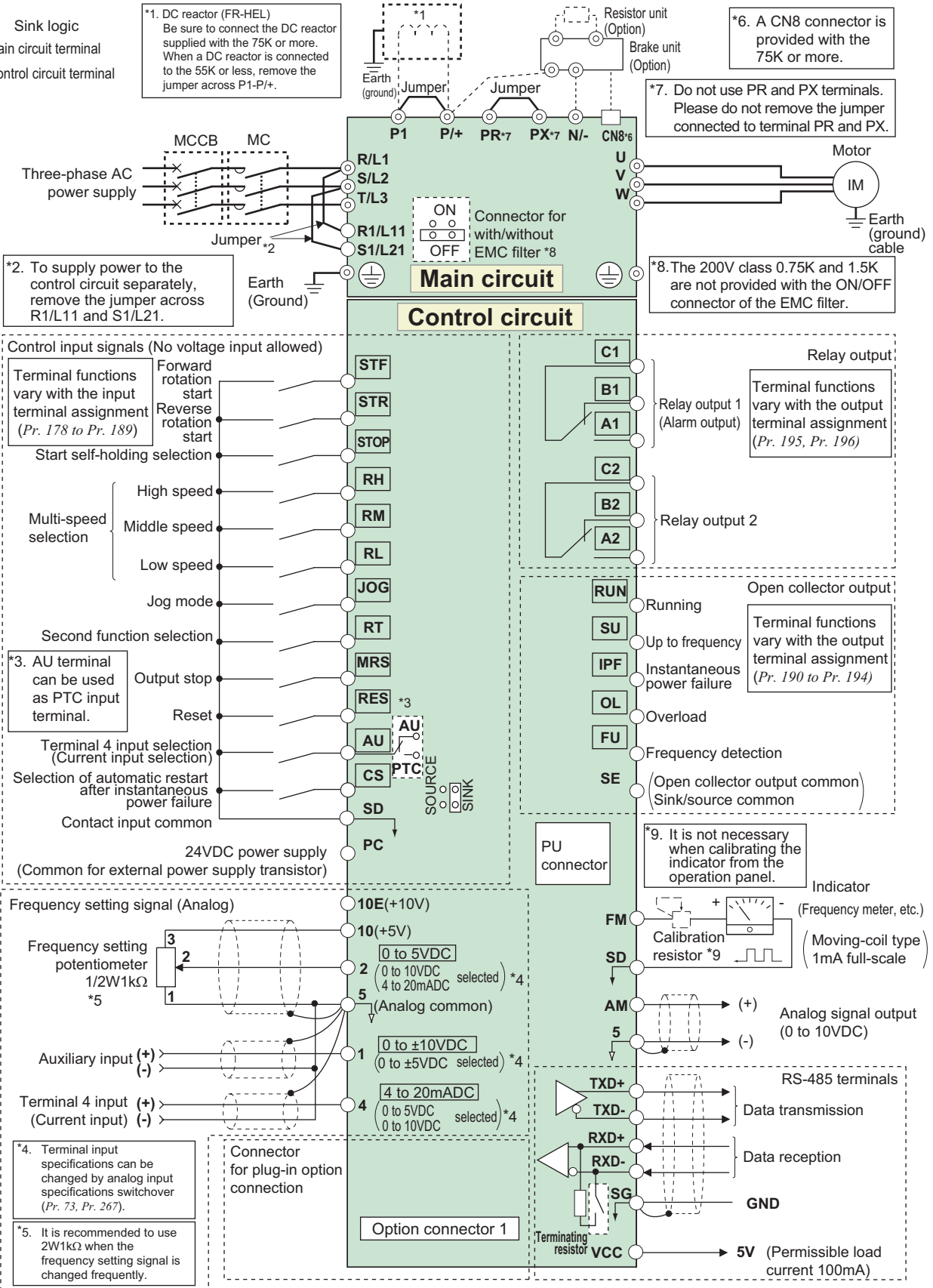

## CAUTION

- To prevent a malfunction due to noise, keep the signal cables more than 10cm away from the power cables.
- Be sure to use the inverter and motor after grounding (earthing) them.
- This connection diagram assumes that the control circuit is sink logic (initial setting). Refer to the instruction manual for the connection in the case of source logic.

Features

Peripheral Devices  
Why energy savings?

Standard Specifications

Outline Dimension Drawings

Terminal Connection Diagram  
Terminal Specification Explanation

Operation Panel

Parameter List

Explanations of Parameters

Protective Functions

Options

Instructions

Motor

Compatibility

Warranty

Inquiry

# Terminal Specification Explanation

Type	Terminal Symbol	Terminal Name	Description
Main circuit	R/L1, S/L2, T/L3	AC power input	Connect to the commercial power supply.
	U, V, W	Inverter output	Connect a three-phase squirrel-cage motor.
	R1/L11, S1/L21	Power supply for control circuit	Connected to the AC power supply terminals R/L1 and S/L2. To retain the alarm display and alarm output, apply external power to this terminal.
	P/+, N/-	Brake unit connection	Connect the brake unit (FR-BU, BU, MT-BU5), power regeneration common converter (FR-CV), power regeneration converter (MT-RC) or high power factor converter (FR-HC, MT-HC).
	P/+, P1	DC reactor connection	For the 55K or less, remove the jumper across terminals P/+ - P1 and connect the DC reactor. (For the 75K or more, a DC reactor is supplied as standard.)
	PR, PX	Please do not remove or use terminals PR and PX or the jumper connected.	
		Earth (Ground)	For earthing (grounding) the inverter chassis. Must be earthed (grounded).
Control circuit input	STF	Forward rotation start	Turn on the STF signal to start forward rotation and turn it off to stop. When the STF and STR signals are turned on simultaneously, the stop command is given.
	STR	Reverse rotation start	Turn on the STR signal to start reverse rotation and turn it off to stop.
	STOP	Start self-holding selection	Turn on the STOP signal to self-hold the start signal.
	RH, RM, RL	Multi-speed selection	Multi-speed can be selected according to the combination of RH, RM and RL signals.
	JOG	Jog mode selection	Turn on the JOG signal to select Jog operation (initial setting) and turn on the start signal (STF or STR) to start Jog operation.
	RT	Second acceleration/ deceleration time selection	Turn on the RT signal to select second acceleration/deceleration time. When the second function such as "second torque boost" and "second V/F (base frequency)" are set, turning on the RT signal selects these functions.
	MRS	Output stop	Turn on the MRS signal (20ms or more) to stop the inverter output. Use to shut off the inverter output when stopping the motor by electromagnetic brake.
	RES	Reset	Used to reset alarm output provided when protective function is activated. Turn on the RES signal for more than 0.1s, then turn it off. Recover about 1s after reset is cancelled.
	AU	Terminal 4 input selection	Terminal 4 is made valid only when the AU signal is turned on. (The frequency setting signal can be set between 4 and 20mADC.) Turning the AU signal on makes terminal 2 (voltage input) invalid.
		PTC input	AU terminal is used as PTC input terminal (thermal protection of the motor). When using it as PTC input terminal, set the AU/PTC switch to PTC.
	CS	Selection of automatic restart after instantaneous power failure	When the CS signal is left on, the inverter restarts automatically at power restoration. Note that restart setting is necessary for this operation. In the initial setting, a restart is disabled.
	SD	Contact input common (sink)	Common terminal for contact input terminal (sink logic) and terminal FM. Common output terminal for 24VDC 0.1A power supply (PC terminal). Isolated from terminals 5 and SE.
	PC	External transistor common, 24VDC power supply, contact input common (source)	When connecting the transistor output (open collector output), such as a programmable controller (PLC), when sink logic is selected, connect the external power supply common for transistor output to this terminal to prevent a malfunction caused by undesirable currents. Can be used as 24VDC 0.1A power supply. When source logic has been selected, this terminal serves as a contact input common.
	Frequency setting	10E	Frequency setting power supply
10		Change the input specifications when connecting it to terminal 10E. 5VDC, Permissible load current 10mA.	
2		Frequency setting (voltage)	Inputting 0 to 5VDC (or 0 to 10V, 4 to 20mA) provides the maximum output frequency at 5V (10V, 20mA) and makes input and output proportional. Use Pr.73 to switch from among input 0 to 5VDC (initial setting), 0 to 10VDC, and 4 to 20mA. Voltage input: Input resistance 10kΩ ± 1kΩ Maximum permissible voltage 20VDC Current input: Input resistance 250Ω ± 2% Maximum permissible current 30mA
4		Frequency setting (current)	Inputting 4 to 20mADC (or 0 to 5V, 0 to 10V) provides the maximum output frequency at 20mA (5V, 10V) makes input and output proportional. This input signal is valid only when the AU signal is on (terminal 2 input is invalid). Use Pr.267 to switch between the input 4 to 20mA and 0 to 5VDC, 0 to 10VDC (initial setting). Voltage input: Input resistance 10kΩ ± 1kΩ Maximum permissible voltage 20VDC Current input: Input resistance 250Ω ± 2% Maximum permissible current 30mA
1		Frequency setting auxiliary	Inputting 0 to ±5 VDC or 0 to ±10VDC adds this signal to terminal 2 or 4 frequency setting signal. Use Pr.73 to switch between the input 0 to ±5VDC and 0 to ±10VDC (initial setting). Input resistance 10kΩ ± 1kΩ, Maximum permissible voltage ± 20VDC
5		Frequency setting common	Common terminal for frequency setting signal (terminal 2, 1 or 4) and analog output terminal AM. Do not earth (ground).



Type	Terminal Symbol	Terminal Name	Description	
Control circuit/output signal	Relay	A1, B1, C1	Relay output 1 (alarm output) Changeover contact output indicates that the inverter protective function has activated and the output stopped. Abnormal: No conduction across B-C (Across A-C Continuity), Normal: Across B-C Continuity (No conduction across A-C) Contact capacity: 230VAC 0.3A (Power factor=0.4) 30VDC 0.3A	
		A2, B2, C2	Relay output 2 1 changeover contact output Contact capacity: 230VAC 0.3A (Power factor=0.4) 30VDC 0.3A	
	Open collector	RUN	Inverter running	Switched low when the inverter output frequency is equal to or higher than the starting frequency (initial value 0.5Hz). Switched high during stop or DC injection brake operation.*1
		SU	Up to frequency	Switched low when the output frequency reaches within the range of ±10% (initial value) of the set frequency. Switched high during acceleration/deceleration and at a stop.*1
		OL	Overload alarm	Switched low when stall prevention is activated by the stall prevention function. Switched high when stall prevention is cancelled. *1
		IPF	Instantaneous power failure	Switched low when an instantaneous power failure and under voltage protections are activated. *1
		FU	Frequency detection	Switched low when the inverter output frequency is equal to or higher than the preset detected frequency and high when less than the preset detected frequency. *1
		SE	Open collector output common	Common terminal for terminals RUN, SU, OL, IPF, FU
	Pulse	FM	For meter	Output item: Output frequency (initial setting) Permissible load current 2mA 1440 pulses/s at 60Hz
		AM	Analog signal output	Select one e.g. output frequency from monitor items. *2 The output signal is proportional to the magnitude of the corresponding monitoring item. Output item: Output frequency (initial setting) Output signal 0 to 10VDC Permissible load current 1mA (load impedance 10kΩ or more) Resolution 8 bit
Communication	PU connector		PU connector With the PU connector, communication can be made through RS-485. (for connection on a 1:1 basis only) . Conforming standard : EIA-485(RS-485) . Transmission format : Multidrop . Communication speed : 4800 to 38400bps . Overall length : 500m	
	RS-485 terminal	TXD+	Inverter transmission terminal	With the RS-485 terminal, communication can be made through RS-485. Conforming standard : EIA-485 (RS-485)
		TXD-	Inverter reception terminal	Transmission format : Multidrop link
		RXD+	Inverter reception terminal	Communication speed : 300 to 38400bps
		RXD-	Inverter reception terminal	Overall length : 500m
SG	Earth (Ground)			

**CAUTION**

- The inverter will be damaged if power is applied to the inverter output terminals (U, V, W). Never perform such wiring.
- indicates that terminal functions can be selected from Pr. 178 to Pr. 196 (I/O terminal function selection)
- \*1. Low indicates that the open collector output transistor is on (conducts). High indicates that the transistor is off (does not conduct).
- \*2. Not output during inverter reset.

- Features
- Peripheral Devices  
Why energy savings?
- Standard Specifications
- Outline Dimension Drawings
- Terminal Connection Diagram  
Terminal Specification Explanation
- Operation Panel
- Parameter List
- Explanations of Parameters
- Protective Functions
- Options
- Instructions
- Motor
- Compatibility
- Warranty
- Inquiry

# Explanation of the Operation Panel (FR-DU07)

### Operation mode indication

PU: Lit to indicate PU operation mode.  
 EXT: Lit to indicate external operation mode.  
 NET: Lit to indicate network operation mode.

### Unit indication

· Hz: Lit to indicate frequency.  
 · A: Lit to indicate current.  
 · V: Lit to indicate voltage.  
 (Flicker when the set frequency monitor is displayed.)

### Rotation direction indication

FWD: Lit during forward rotation  
 REV: Lit during reverse rotation  
 On: Forward/reverse operation  
 Flickering: When the frequency command is not given even if the forward/reverse command is given.

### Monitor indication

Lit to indicate monitoring mode.

### Monitor(4-digit LED)

Shows the frequency, parameter number, etc.

### No function

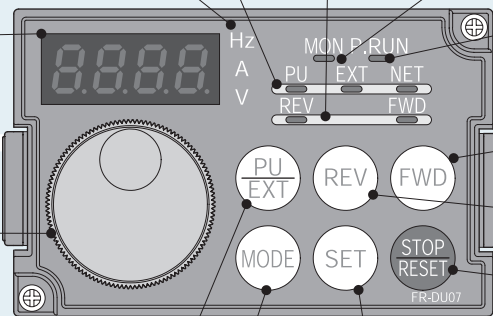

FWD: Operation command forward rotation

REV: Operation command reverse rotation

STOP/RESET: Stop operation  
 Alarms can be reset

### Setting dial

(Setting dial: Mitsubishi inverter dial)

Used to change the frequency setting and parameter values.

Used to set each setting.  
 If pressed during operation, monitor changes as below;



\* Energy saving monitor is displayed when the energy saving monitor of Pr. 52 is set.

MODE: Mode switchover  
 Used to change each setting mode.

### Operation mode switchover

Used to switch between the PU and external operation mode.  
 When using the external operation mode (operation using a separately connected frequency setting potentiometer and start signal), press this key to light up the EXT indication. (Change the Pr. 79 value to use the combined mode.)  
 PU: PU operation mode  
 EXT: External operation mode



● Basic operation

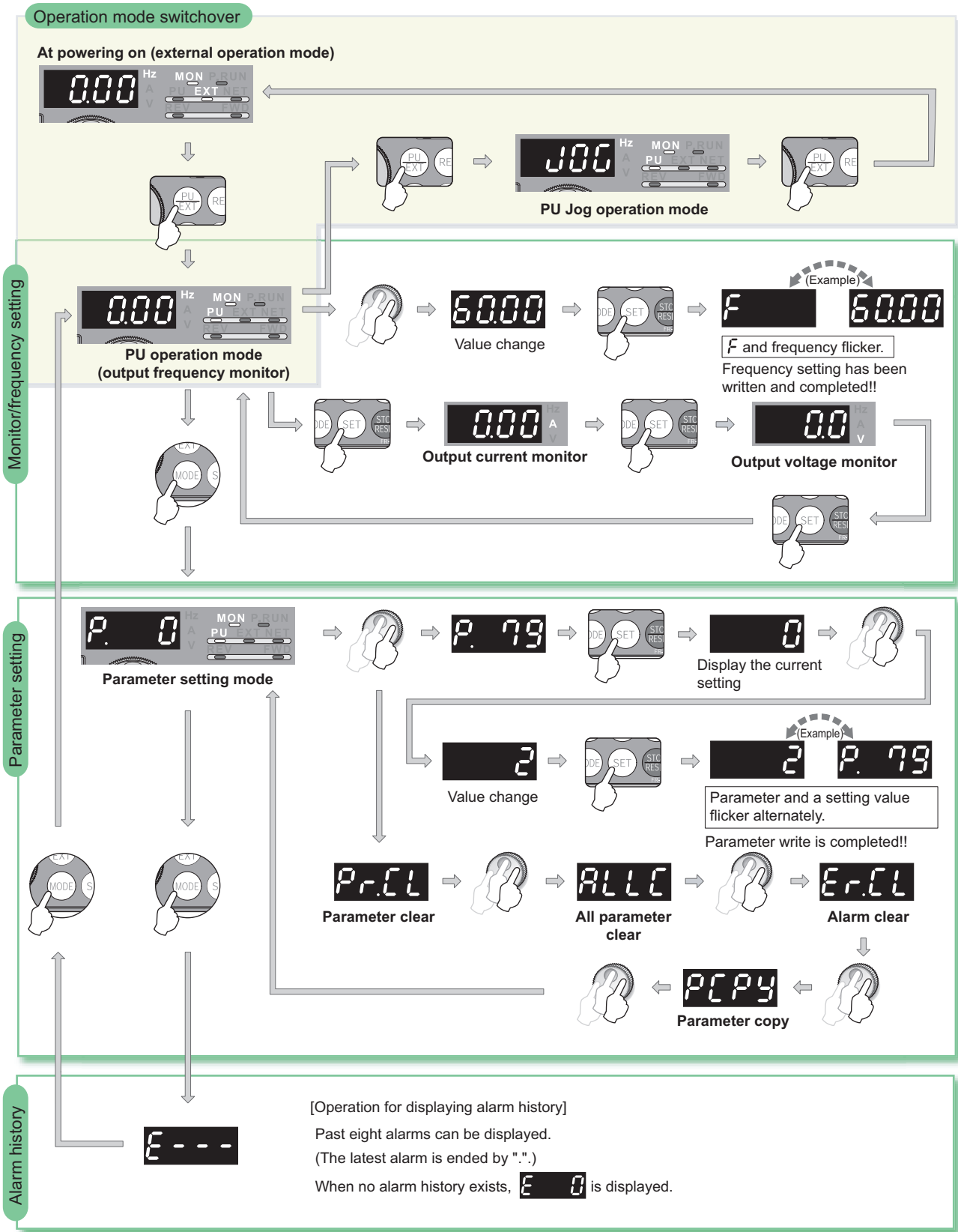

- Features
- Peripheral Devices  
Why energy savings?
- Standard Specifications
- Outline Dimension Drawings
- Terminal Connection Diagram  
Terminal Specification Explanation
- Operation Panel
- Parameter List
- Explanations of Parameters
- Protective Functions
- Options
- Instructions
- Motor
- Compatibility
- Warranty
- Inquiry

# Parameter List

For simple variable-speed operation of the inverter, the initial setting of the parameters may be used as they are. Set the necessary parameters to meet the load and operational specifications. Parameter setting, change and check can be made from the operation panel (FR-DU07). For details of parameters, refer to the instruction manual.

**POINT**

Only simple mode parameters are displayed by the initial setting of *Pr.160 User group read selection*. Set *Pr.160 User group read selection* as required.

●Simple mode parameter

Parameter Number	Name	Range	Increments	Initial Value	Refer to page
0	Torque boost	0 to 30%	0.1%	6/4/3/2/1.5/1%*2	28
1	Maximum frequency	0 to 120Hz	0.01Hz	120/60Hz*1	28
2	Minimum frequency	0 to 120Hz	0.01Hz	0Hz	28
3	Base frequency	0 to 400Hz	0.01Hz	60Hz	28
4	Multi-speed setting (high speed)	0 to 400Hz	0.01Hz	60Hz	28
5	Multi-speed setting (middle speed)	0 to 400Hz	0.01Hz	30Hz	28
6	Multi-speed setting (low speed)	0 to 400Hz	0.01Hz	10Hz	28
7	Acceleration time	0 to 3600/ 360s	0.1/0.01s	5s/15s*3	28
8	Deceleration time	0 to 3600/ 360s	0.1/0.01s	10s/30s*3	28
9	Electronic thermal O/L relay	0 to 500/ 0 to 3600A*1	0.01/0.1A*1	Rated inverter output current	29
60	Energy saving control selection	0, 4, 9	1	0	34
79	Operation mode selection	0, 1, 2, 3, 4, 6, 7	1	0	37
125	Terminal 2 frequency setting gain frequency	0 to 400Hz	0.01Hz	60Hz	39
126	Terminal 4 frequency setting gain frequency	0 to 400Hz	0.01Hz	60Hz	39
160	User group read selection	0, 1, 9999	1	9999	40

●Extended mode parameter

**Remarks**

- The parameters marked with © indicate simple mode parameters.
- The shaded parameters in the table allow its setting to be changed during operation even if "0" (initial value) is set in *Pr. 77 Parameter write selection*.

Function	Parameters	Name	Setting Range	Increments	Initial Value	Refer to page
Basic functions	© 0	Torque boost	0 to 30%	0.1%	6/4/3/2/1.5/1%*2	28
	© 1	Maximum frequency	0 to 120Hz	0.01Hz	120/60Hz*1	28
	© 2	Minimum frequency	0 to 120Hz	0.01Hz	0Hz	28
	© 3	Base frequency	0 to 400Hz	0.01Hz	60Hz	28
	© 4	Multi-speed setting (high speed)	0 to 400Hz	0.01Hz	60Hz	28
	© 5	Multi-speed setting (middle speed)	0 to 400Hz	0.01Hz	30Hz	28
	© 6	Multi-speed setting (low speed)	0 to 400Hz	0.01Hz	10Hz	28
	© 7	Acceleration time	0 to 3600/ 360s	0.1/0.01s	5s/15s*3	28
	© 8	Deceleration time	0 to 3600/ 360s	0.1/0.01s	10s/30s*3	28
DC Injection Brake	10	DC injection brake operation frequency	0 to 120Hz, 9999	0.01Hz	3Hz	29
	11	DC injection brake operation time	0 to 10s	0.1s	0.5s	29
	12	DC injection brake operation voltage	0 to 30%	0.1%	4/2/1%*4	29
—	13	Starting frequency	0 to 60Hz	0.01Hz	0.5Hz	29
—	14	Load pattern selection	0, 1	1	1	29
Jog operation	15	Jog frequency	0 to 400Hz	0.01Hz	5Hz	29
	16	Jog acceleration/deceleration time	0 to 3600/360s	0.1/0.01s	0.5s	29

\*1 Differ according to capacities. (55K or less/75K or more)  
 \*2 Differ according to capacities. (0.75K/1.5K to 3.7K/5.5K, 7.5K/11K to 37K/45K, 55K/75K or more)  
 \*3 Differ according to capacities. (7.5K or less/11K or more)  
 \*4 Differ according to capacities. (7.5K or less/11K to 55K/75K or more)

Function	Parameters	Name	Setting Range	Increments	Initial Value	Refer to page
—	17	MRS input selection	0, 2	1	0	29
—	18	High speed maximum frequency	120 to 400Hz	0.01Hz	120/60Hz*1	28
—	19	Base frequency voltage	0 to 1000V, 8888, 9999	0.1V	9999	28
Acceleration and deceleration times	20	Acceleration/deceleration reference frequency	1 to 400Hz	0.01Hz	60Hz	28
	21	Acceleration/deceleration time increments	0, 1	1	0	28
Stall prevention	22	Stall prevention operation level	0 to 150%, 9999	0.1%	120%	30
	23	Stall prevention operation level compensation factor at double speed	0 to 200%, 9999	0.1%	9999	30
Multi-speed setting	24 to 27	Multi-speed setting 4 speed to 7 speed	0 to 400Hz, 9999	0.01Hz	9999	28
—	28	Multi-speed input compensation selection	0, 1	1	0	30
—	29	Acceleration/deceleration pattern selection	0, 1, 2, 3	1	0	30
—	30	Regenerative function selection	0, 2/0, 1, 2*1	1	0	31
Frequency jump	31	Frequency jump 1A	0 to 400Hz, 9999	0.01Hz	9999	31
	32	Frequency jump 1B	0 to 400Hz, 9999	0.01Hz	9999	31
	33	Frequency jump 2A	0 to 400Hz, 9999	0.01Hz	9999	31
	34	Frequency jump 2B	0 to 400Hz, 9999	0.01Hz	9999	31
	35	Frequency jump 3A	0 to 400Hz, 9999	0.01Hz	9999	31
	36	Frequency jump 3B	0 to 400Hz, 9999	0.01Hz	9999	31
—	37	Speed display	0, 1 to 9998	1	0	31
Frequency detection	41	Up-to-frequency sensitivity	0 to 100%	0.1%	10%	31
	42	Output frequency detection	0 to 400Hz	0.01Hz	6Hz	31
	43	Output frequency detection for reverse rotation	0 to 400Hz, 9999	0.01Hz	9999	31
Second functions	44	Second acceleration/deceleration time	0 to 3600/360s	0.1/0.01s	5s	28
	45	Second deceleration time	0 to 3600/360s, 9999	0.1/0.01s	9999	28
	46	Second torque boost	0 to 30%, 9999	0.1%	9999	28
	47	Second V/F (base frequency)	0 to 400Hz, 9999	0.01Hz	9999	28
	48	Second stall prevention operation current	0 to 150%	0.1%	120%	30
	49	Second stall prevention operation frequency	0 to 400Hz, 9999	0.01Hz	0Hz	30
	50	Second output frequency detection	0 to 400Hz	0.01Hz	30Hz	31
	51	Second electronic thermal O/L relay	0 to 500A, 9999 / 0 to 3600A, 9999*1	0.01/0.1A*1	9999	29
Monitor functions	52	DU/PU main display data selection	0, 5, 6, 8 to 14, 17, 20, 23 to 25, 50 to 57, 100	1	0	32
	54	FM terminal function selection	1 to 3, 5, 6, 8 to 14, 17, 21, 24, 50, 52, 53	1	1	32
	55	Frequency monitoring reference	0 to 400Hz	0.01Hz	60Hz	32
	56	Current monitoring reference	0 to 500/0 to 3600A*1	0.01/0.1A*1	Rated inverter output current	32
Automatic restart functions	57	Restart coasting time	0, 0.1 to 5s, 9999/ 0, 0.1 to 30s, 9999*1	0.1s	9999	33
	58	Restart cushion time	0 to 60s	0.1s	1s	33
—	59	Remote function selection	0, 1, 2, 3	1	0	33
—	© 60	Energy saving control selection	0, 4, 9	1	0	34
—	65	Retry selection	0 to 5	1	0	34

\*1 Differ according to capacities. (55K or less/75K or more)

Features
Peripheral Devices Why energy savings?
Standard Specifications
Outline Dimension Drawings
Terminal Connection Diagram Terminal Specification Explanation
Operation Panel
Parameter List
Explanations of Parameters
Protective Functions
Options
Instructions
Motor
Compatibility
Warranty
Inquiry

Function	Parameters	Name	Setting Range	Increments	Initial Value	Refer to page
—	66	Stall prevention operation reduction starting frequency	0 to 400Hz	0.01Hz	60Hz	30
Retry	67	Number of retries at alarm occurrence	0 to 10, 101 to 110	1	0	34
	68	Retry waiting time	0 to 10s	0.1s	1s	34
	69	Retry count display erase	0	1	0	34
—	70	Special regenerative brake duty *2	0 to 10%	0.1%	0%	31
—	71	Applied motor	0, 1, 2, 20	1	0	34
—	72	PWM frequency selection	0 to 15/0 to 6, 25*1	1	2	35
—	73	Analog input selection	0 to 7, 10 to 17	1	1	35
—	74	Input filter time constant	0 to 8	1	1	36
—	75	Reset selection/disconnected PU detection/PU stop selection	0 to 3, 14 to 17	1	14	36
—	76	Alarm code output selection	0, 1, 2	1	0	36
—	77	Parameter write selection	0, 1, 2	1	0	36
—	78	Reverse rotation prevention selection	0, 1, 2	1	0	36
—	⊙ 79	Operation mode selection	0, 1, 2, 3, 4, 6, 7	1	0	37
Simple magnetic flux vector control	80	Motor capacity (simple magnetic flux vector control)	0.4 to 55kW, 9999 /0 to 3600kW, 9999*1	0.01/0.1kW*1	9999	37
	90	Motor constant (R1)	0 to 50Ω, 9999 /0 to 400mΩ, 9999*1	0.001Ω/ 0.01mΩ*1	9999	37
Adjustable 5 points V/F	100	V/F1 (first frequency)	0 to 400Hz, 9999	0.01Hz	9999	38
	101	V/F1 (first frequency voltage)	0 to 1000V	0.1V	0V	38
	102	V/F2 (second frequency)	0 to 400Hz, 9999	0.01Hz	9999	38
	103	V/F2 (second frequency voltage)	0 to 1000V	0.1V	0V	38
	104	V/F3 (third frequency)	0 to 400Hz, 9999	0.01Hz	9999	38
	105	V/F3 (third frequency voltage)	0 to 1000V	0.1V	0V	38
	106	V/F4 (fourth frequency)	0 to 400Hz, 9999	0.01Hz	9999	38
	107	V/F4 (fourth frequency voltage)	0 to 1000V	0.1V	0V	38
	108	V/F5 (fifth frequency)	0 to 400Hz, 9999	0.01Hz	9999	38
109	V/F5 (fifth frequency voltage)	0 to 1000V	0.1V	0V	38	
PU connector communication	117	PU communication station	0 to 31	1	0	38
	118	PU communication speed	48, 96, 192, 384	1	192	38
	119	PU communication stop bit length.	0, 1, 10, 11	1	1	38
	120	PU communication parity check	0, 1, 2	1	2	38
	121	Number of PU communication retries	0 to 10, 9999	1	1	38
	122	PU communication check time interval	0, 0.1 to 999.8s, 9999	0.1s	9999	38
	123	PU communication waiting time setting	0 to 150ms, 9999	1	9999	38
124	PU communication CR/LF presence/absence selection	0, 1, 2	1	1	38	
—	⊙ 125	Terminal 2 frequency setting gain frequency	0 to 400Hz	0.01Hz	60Hz	39
—	⊙ 126	Terminal 4 frequency setting gain frequency	0 to 400Hz	0.01Hz	60Hz	39
PID operation	127	PID control automatic switchover frequency	0 to 400Hz, 9999	0.01Hz	9999	39
	128	PID action selection	10, 11, 20, 21, 50, 51, 60, 61	1	10	39
	129	PID proportional band	0.1 to 1000%, 9999	0.1%	100%	39
	130	PID integral time	0.1 to 3600s, 9999	0.1s	1s	39
	131	PID upper limit	0 to 100%, 9999	0.1%	9999	39
	132	PID lower limit	0 to 100%, , 9999	0.1%	9999	39
	133	PID action set point	0 to 100%, 9999	0.01%	9999	39
134	PID differential time	0.01 to 10.00s, 9999	0.01s	9999	39	

\*1 Differ according to capacities. (55K or less/75K or more)

\*2 Setting can be made for the 75K or more.

Function	Parameters	Name	Setting Range	Increments	Initial Value	Refer to page
Commercial power supply-inverter switch-over	135	Commercial power-supply switchover sequence output terminal selection	0, 1	1	0	39
	136	MC switchover interlock time	0 to 100s	0.1s	1s	39
	137	Waiting time at a start	0 to 100s	0.1s	0.5s	39
	138	Commercial power-supply operation switchover selection at an alarm	0, 1	1	0	39
	139	Automatic switchover frequency between inverter and commercial power-supply operation	0 to 60Hz, 9999	0.01Hz	9999	39
Backlash measures	140	Backlash acceleration stopping frequency	0 to 400Hz	0.01Hz	1Hz	30
	141	Backlash acceleration stopping time	0 to 360s	0.1s	0.5s	30
	142	Backlash deceleration stopping frequency	0 to 400Hz	0.01Hz	1Hz	30
	143	Backlash deceleration stopping time	0 to 360s	0.1s	0.5s	30
—	144	Speed setting switchover	0, 2, 4, 6, 8, 10, 102, 104, 106, 108, 110	1	4	31
PU	145	PU display language selection	0 to 7	1	0	40
Current detection	148	Stall prevention level at 0V input.	0 to 150%	0.1%	120%	30
	149	Stall prevention level at 10V input.	0 to 150%	0.1%	150%	30
	150	Output current detection level	0 to 150%	0.1%	120%	40
	151	Output current detection signal delay time	0 to 10s	0.1s	0s	40
	152	Zero current detection level	0 to 150%	0.1%	5%	40
	153	Zero current detection time	0 to 1s	0.01s	0.5s	40
—	154	Voltage reduction selection during stall prevention operation	0, 1	1	1	30
—	155	RT signal reflection time selection	0, 10	1	0	40
—	156	Stall prevention operation selection	0 to 31, 100, 101	1	0	30
—	157	OL signal output timer	0 to 25s, 9999	0.1s	0s	30
—	158	AM terminal function selection	1 to 3, 5, 6, 8 to 14, 17, 21, 24, 50, 52, 53	1	1	32
—	159	Automatic switchover ON range between commercial power-supply and inverter operation	0 to 10Hz, 9999	0.01Hz	9999	39
—	©160	User group read selection	0, 1, 9999	1	9999	40
—	161	Frequency setting/key lock operation selection	0, 1, 10, 11	1	0	41
Automatic restart functions	162	Automatic restart after instantaneous power failure selection	0, 1, 10, 11	1	0	33
	163	First cushion time for restart	0 to 20s	0.1s	0s	33
	164	First cushion voltage for restart	0 to 100%	0.1%	0%	33
	165	Stall prevention operation level for restart	0 to 150%	0.1%	120%	33
Current detection	166	Output current detection signal retention time	0 to 10s, 9999	0.1s	0.1s	40
	167	Output current detection operation selection	0, 1	1	0	40
—	168	Parameter for manufacturer setting. Do not set.				
—	169	Parameter for manufacturer setting. Do not set.				
Cumulative monitor clear	170	Cumulative power meter clear	0, 10, 9999	1	9999	32
	171	Operation hour meter clear	0, 9999	1	9999	32
User group	172	User group registered display/batch clear	9999, (0 to 16)	1	0	40
	173	User group registration	0 to 999, 9999	1	9999	40
	174	User group clear	0 to 999, 9999	1	9999	40

Features
Peripheral Devices Why energy savings?
Standard Specifications
Outline Dimension Drawings
Terminal Connection Diagram Terminal Specification Explanation
Operation Panel
Parameter List
Explanations of Parameters
Protective Functions
Options
Instructions
Motor
Compatibility
Warranty
Inquiry

Function	Parameters	Name	Setting Range	Increments	Initial Value	Refer to page
Input terminal function assignment	178	STF terminal function selection	0 to 8, 10 to 12, 14, 16, 24, 25, 60, 62, 64 to 67, 9999	1	60	41
	179	STR terminal function selection	0 to 8, 10 to 12, 14, 16, 24, 25, 61, 62, 64 to 67, 9999	1	61	41
	180	RL terminal function selection	0 to 8, 10 to 12, 14, 16, 24, 25, 62, 64 to 67, 9999	1	0	41
	181	RM terminal function selection		1	1	41
	182	RH terminal function selection		1	2	41
	183	RT terminal function selection		1	3	41
	184	AU terminal function selection	0 to 8, 10 to 12, 14, 16, 24, 25, 62 to 67, 9999	1	4	41
	185	JOG terminal function selection	0 to 8, 10 to 12, 14, 16, 24, 25, 62, 64 to 67, 9999	1	5	41
	186	CS terminal function selection		1	6	41
	187	MRS terminal function selection		1	24	41
	188	STOP terminal function selection		1	25	41
189	RES terminal function selection	1		62	41	
Output terminal function assignment	190	RUN terminal function selection	0 to 5, 7, 8, 10 to 19, 25, 26, 45 to 47, 64, 70, 90 to 96, 98, 99, 100 to 105, 107, 108, 110 to 116, 125, 126, 145 to 147, 164, 170, 190 to 196, 198, 199, 9999	1	0	41
	191	SU terminal function selection		1	1	41
	192	IPF terminal function selection		1	2	41
	193	OL terminal function selection		1	3	41
	194	FU terminal function selection		1	4	41
	195	ABC1 terminal function selection		1	99	41
	196	ABC2 terminal function selection	0 to 5, 7, 8, 10 to 19, 25, 26, 45 to 47, 64, 70, 90, 91, 94 to 96, 98, 99, 100 to 105, 107, 108, 110 to 116, 125, 126, 145 to 147, 164, 170, 190, 191, 194 to 196, 198, 199, 9999	1	9999	41
Multi-speed setting	232 to 239	Multi-speed setting 8 speed to 15 speed	0 to 400Hz, 9999	0.01Hz	9999	28
—	240	Soft-PWM operation selection	0, 1	1	1	35
—	241	Analog input display unit switchover	0, 1	1	0	39
—	242	Terminal 1 added compensation amount (terminal 2)	0 to 100%	0.1%	100%	35
—	243	Terminal 1 added compensation amount (terminal 4)	0 to 100%	0.1%	75%	35
—	244	Cooling fan operation selection	0, 1	1	1	42
Slip compensation	245	Rated slip	0 to 50%, 9999	0.01%	9999	42
	246	Slip compensation time constant	0.01 to 10s	0.01s	0.5s	42
	247	Constant-output region slip compensation selection	0, 9999	1	9999	42
—	250	Stop selection	0 to 100s, 1000 to 1100s, 8888, 9999	0.1s	9999	42
—	251	Output phase failure protection selection	0, 1	1	1	42
Frequency compensation function	252	Override bias	0 to 200%	0.1%	50%	35
	253	Override gain	0 to 200%	0.1%	150%	35
Life check	255	Life alarm status display	(0 to 15)	1	0	42
	256	Inrush current limit circuit life display	(0 to 100%)	1%	100%	42
	257	Control circuit capacitor life display	(0 to 100%)	1%	100%	42
	258	Main circuit capacitor life display	(0 to 100%)	1%	100%	42
	259	Main circuit capacitor life measuring	0, 1	1	0	42
—	260	PWM frequency automatic switchover	0, 1	1	1	35



Function	Parameters	Name	Setting Range	Increments	Initial Value	Refer to page	
Power failure stop	261	Power failure stop selection	0, 1, 2	1	0	43	
	262	Subtracted frequency at deceleration start	0 to 20Hz	0.01Hz	3Hz	43	
	263	Subtraction starting frequency	0 to 120Hz, 9999	0.01Hz	60Hz	43	
	264	Power-failure deceleration time 1	0 to 3600/ 360s	0.1/0.01s	5s	43	
	265	Power-failure deceleration time 2	0 to 3600/ 360s, 9999	0.1/0.01s	9999	43	
	266	Power failure deceleration time switchover frequency	0 to 400Hz	0.01Hz	60Hz	43	
—	267	Terminal 4 input selection	0, 1, 2	1	0	35	
—	268	Monitor decimal digits selection	0, 1, 9999	1	9999	32	
—	269	Parameter for manufacturer setting. Do not set.					
—	299	Rotation direction detection selection at restarting	0, 1, 9999	1	9999	33	
RS-485 communication	331	RS-485 communication station	0 to 31(0 to 247)	1	0	38	
	332	RS-485 communication speed	3, 6, 12, 24, 48, 96, 192, 384	1	96	38	
	333	RS-485 communication stop bit length	0, 1, 10, 11	1	1	38	
	334	RS-485 communication parity check selection	0, 1, 2	1	2	38	
	335	RS-485 communication number of retries	0 to 10, 9999	1	1	38	
	336	RS-485 communication check time interval	0, 0.1 to 999.8s, 9999	0.1s	0s	38	
	337	RS-485 communication waiting time setting	0 to 150ms, 9999	1	9999	38	
	338	Communication operation command source	0, 1	1	0	44	
	339	Communication speed command source	0, 1, 2	1	0	44	
	340	Communication startup mode selection	0, 1, 2, 10, 12	1	0	37	
	341	RS-485 communication CR/LF selection	0, 1, 2	1	1	38	
	342	Communication EEPROM write selection	0, 1	1	0	38	
	343	Communication error count	—	1	0	38	
Remote output	495	Remote output selection	0, 1	1	0	44	
	496	Remote output data 1	0 to 4095	1	0	44	
	497	Remote output data 2	0 to 4095	1	0	44	
Maintenance	503	Maintenance timer	0 (1 to 9998)	1	0	44	
	504	Maintenance timer alarm output set time	0 to 9998, 9999	1	9999	44	
Communication	549	Protocol selection	0, 1	1	0	38	
	550	NET mode operation command source selection	0, 1, 9999	1	9999	44	
	551	PU mode operation command source selection	1, 2	1	2	44	
Current average monitor	555	Current average time	0.1 to 1.0s	0.1s	1s	44	
	556	Data output mask time	0.0 to 20.0s	0.1s	0s	44	
	557	Current average value monitor signal output reference current	0 to 500/0 to 3600A*1	0.01/0.1A*1	Rated inverter current	44	
—	563	Energization time carrying-over times	0 to 65535	1	0	32	
—	564	Operating time carrying-over times	0 to 65535	1	0	32	
—	571	Holding time at a start	0.0 to 10.0s, 9999	0.1s	9999	29	
PID control	575	Output interruption detection time	0 to 3600s, 9999	0.1s	1s	39	
	576	Output interruption detection level	0 to 400Hz	0.01Hz	0Hz	39	
	577	Output interruption release level	900 to 1100%	0.1%	1000%	39	
—	611	Acceleration time at a restart	0 to 3600s, 9999	0.1s	5/15s*1	33	

\*1 Differ according to capacities. (55K or less/75K or more)

- Features
- Peripheral Devices  
Why energy savings?
- Standard Specifications
- Outline Dimension Drawings
- Terminal Connection Diagram  
Terminal Specification Explanation
- Operation Panel
- Parameter List
- Explanations of Parameters
- Protective Functions
- Options
- Instructions
- Motor
- Compatibility
- Warranty
- Inquiry

Function	Parameters	Name	Setting Range	Increments	Initial Value	Refer to page
—	867	AM output filter	0 to 5s	0.01s	0.01s	32
—	872	Input phase failure protection selection	0, 1	1	0	42
Regeneration avoidance function	882	Regeneration avoidance operation selection	0, 1	1	0	45
	883	Regeneration avoidance operation level	300 to 800V	0.1V	380V/760V*1	45
	884	Regeneration avoidance at deceleration detection sensitivity	0 to 5	1	0	45
	885	Regeneration avoidance compensation frequency limit value	0 to 10Hz, 9999	0.01Hz	6Hz	45
	886	Regeneration avoidance voltage gain	0 to 200%	0.1%	100%	45
Free parameter	888	Free parameter 1	0 to 9999	1	9999	45
	889	Free parameter 2	0 to 9999	1	9999	45
Energy saving monitor	891	Cumulative power monitor digit shifted times	0 to 4, 9999	1	9999	32
	892	Load factor	30 to 150%	0.1%	100%	45
	893	Energy saving monitor reference (motor capacity)	0.1 to 55/0 to 3600kW*2	0.01/0.1kW*2	Inverter rated capacity	45
	894	Control selection during commercial power-supply operation	0, 1, 2, 3	1	0	45
	895	Power saving rate reference value	0, 1, 9999	1	9999	45
	896	Power unit cost	0 to 500, 9999	0.01	9999	45
	897	Power saving monitor average time	0, 1 to 1000h, 9999	1	9999	45
	898	Power saving cumulative monitor clear	0, 1, 10, 9999	1	9999	45
	899	Operation time rate (estimated value)	0 to 100%, 9999	0.1%	9999	45
Calibration parameters	C0 (900)	FM terminal calibration	—	—	—	46
	C1 (901)	AM terminal calibration	—	—	—	46
	C2 (902)	Terminal 2 frequency setting bias frequency	0 to 400Hz	0.01Hz	0Hz	39
	C3 (902)	Terminal 2 frequency setting bias	0 to 300%	0.1%	0%	39
	125 (903)	Terminal 2 frequency setting gain frequency	0 to 400Hz	0.01Hz	60Hz	39
	C4 (903)	Terminal 2 frequency setting gain	0 to 300%	0.1%	100%	39
	C5 (904)	Terminal 4 frequency setting bias frequency	0 to 400Hz	0.01Hz	0Hz	39
	C6 (904)	Terminal 4 frequency setting bias	0 to 300%	0.1%	20%	39
	126 (905)	Terminal 4 frequency setting gain frequency	0 to 400Hz	0.01Hz	60Hz	39
	C7 (905)	Terminal 4 frequency setting gain	0 to 300%	0.1%	100%	39
—	989	Parameter copy alarm release	10/100	1	10/100*2	-
PU	990	PU buzzer control	0, 1	1	1	46
	⊙ 991	PU contrast adjustment	0 to 63	1	58	46
Clear parameters	Pr.CL	Parameter clear	0, 1	1	0	46
	ALLC	All parameter clear	0, 1	1	0	46
	Er.CL	Alarm history clear	0, 1	1	0	46
	PCPY	Parameter copy	0, 1, 2, 3	1	0	46

\*1 The initial value differs according to the voltage class. (200V class / 400V class)

\*2 Differ according to capacities. (55K or less/75K or more)

# Explanations of Parameters

## Pr. 0 Pr. 46 Manual torque boost

Pr.0 Torque boost      Pr.46 Second torque boost

You can compensate for a voltage drop in the low-frequency region to improve motor torque reduction in the low-speed region.

- Motor torque in the low-frequency range can be adjusted to the load to increase the starting motor torque.
- The starting torque boost can be changed by switching terminal RT.
- When simple magnetic flux vector control is selected in Pr. 80, the settings of Pr. 0 and Pr. 46 are invalid.

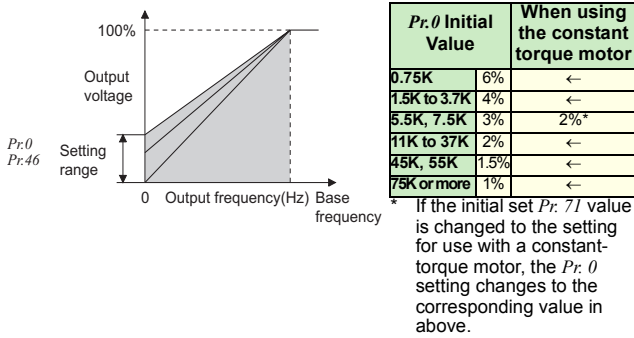

## Pr. 1, 2 Pr. 18 Maximum/minimum frequency

Pr.1 Maximum frequency      Pr.2 Minimum frequency

Pr.18 High speed maximum frequency

You can limit the motor speed.

- Clamp the upper and lower limits of the output frequency.
- When you want to perform operation above 120Hz, set the upper limit of the output frequency to Pr. 18 .  
(When Pr. 18 is set, Pr. 1 automatically switches to the frequency of Pr. 18. When Pr. 1 is set, Pr. 18 is automatically changed to the frequency set in Pr. 1.)

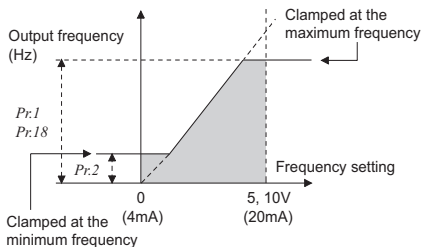

## Pr. 3 Pr. 19, 47 Base frequency, voltage

Pr.3 Base frequency

Pr.19 Base frequency voltage

Pr.47 Second V/F (base frequency)

- Used to adjust the inverter outputs (voltage, frequency) to the motor rating.
- When operating a standard motor, generally set the rated frequency of the motor to Pr. 3 Base frequency. When running the motor using commercial power supply-inverter switch-over operation, set Pr. 3 to the same value as the power supply frequency.
- When you want to change the base frequency when switching multiple motors with one inverter, use the Pr. 47 Second base frequency.
- Use Pr. 19 Base frequency voltage to set the base voltage (e.g. rated motor voltage).

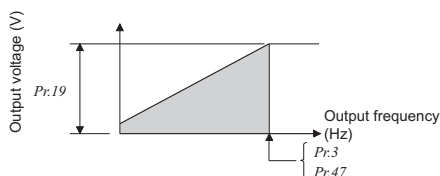

## Pr. 4 to Pr. 6 Pr. 24 to 27, 232 to 239 Multi-speed setting operation

Pr.4 Multi-speed setting (high speed)      Pr.5 Multi-speed setting (middle speed)

Pr.6 Multi-speed setting (low speed)

- Pr.24 Multi-speed setting (speed4)
- Pr.26 Multi-speed setting (speed 6)
- Pr.232 Multi-speed setting (speed 8)
- Pr.234 Multi-speed setting (speed 10)
- Pr.236 Multi-speed setting (speed 12)
- Pr.238 Multi-speed setting (speed 14)
- Pr.25 Multi-speed setting (speed 5)
- Pr.27 Multi-speed setting (speed 7)
- Pr.233 Multi-speed setting (speed 9)
- Pr.235 Multi-speed setting (speed 11)
- Pr.237 Multi-speed setting (speed 13)
- Pr.239 Multi-speed setting (speed 15)

Can be used to change the preset speed in the parameter with the contact signals.

Any speed can be selected by merely turning on-off the contact signals (RH, RM, RL, REX signals).

- The inverter operates at frequencies set in Pr. 4 when RH signal is on, Pr. 5 when RM signal is on and Pr. 6 when RL signal is on.
- Frequency from speed 4 to speed 15 can be set according to the combination of the RH, RM, RL and REX signals. Set the running frequencies to Pr. 24 to Pr. 27, Pr. 232 to Pr. 239. (In the initial value setting, speed 4 to 15 are unavailable.)

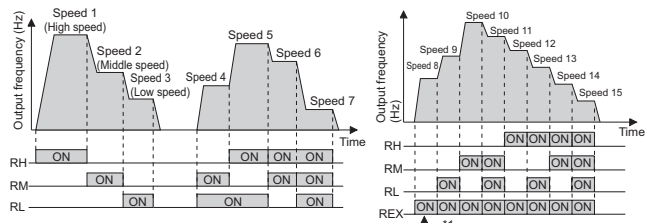

\*1 When turning RH, RM and RL off and REX on with "9999" set in Pr. 232 "multi speed setting (8 speed)", the inverter operates at frequency set in Pr. 6.

## Pr. 7, 8 Pr. 20, 21, 44, 45 Acceleration/deceleration time setting

Pr.7 Acceleration time      Pr.8 Deceleration time

Pr.20 Acceleration/deceleration reference frequency

Pr.21 Acceleration/deceleration time increments

Pr.44 Second acceleration/deceleration time

Pr.45 Second deceleration time

- Used to set motor acceleration/deceleration time.
- Set a larger value for a slower speed increase/decrease or a smaller value for a faster speed increase/decrease.
- Use Pr. 7 Acceleration time to set the acceleration time required to reach Pr. 20 Acceleration/deceleration reference frequency from 0Hz.
- Use Pr. 8 Deceleration time to set the deceleration time required to stop from the Pr. 20 Acceleration/deceleration reference frequency.

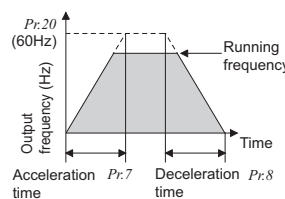

Pr.21 Setting	Description
0 (initial value)	Increments: 0.1s Range: 0 to 3600s Increments and setting range of acceleration/ deceleration time setting can be changed.
1	Increments: 0.01s Range: 0 to 360s

**Pr. 9 Pr. 51 Motor protection from overheat (electronic thermal relay function)**

**Pr.9 Electronic thermal O/L relay** *Pr.51 Second electronic thermal O/L relay*

Set the current of the electronic overcurrent protection to protect the motor from overheat. This feature provides the optimum protective characteristics, including reduced motor cooling capability, at low speed.

- This function detects the overload (overheat) of the motor, stops the operation of the inverter's output transistor, and stops the output.
- Set the rated current [A] of the motor in *Pr.9*.
- When using a motor with an external thermal relay, etc., set "0" in *Pr. 9* to make the electronic thermal relay function invalid. (Note that the output transistor protection of the inverter (E.THT) functions.)
- When using the Mitsubishi constant-torque motor
  - 1) Set "1" in *Pr.71* .  
(This provides a 100% continuous torque characteristic in the low-speed range.)
  - 2) Set the rated motor current in *Pr. 9*.
- When the RT signal is on, thermal protection is provided based on the *Pr. 51* setting.  
Use this function when rotating two motors of different rated currents individually by a single inverter. (When rotating two motors together, use external thermal relays.)

**Pr. 10 to 12 DC injection brake**

**Pr.10 DC injection brake operation frequency** *Pr.11 DC injection brake operation time*  
**Pr.12 DC injection brake operation voltage**

The DC injection brake can be operated at a motor stop to adjust the stop timing and braking torque.

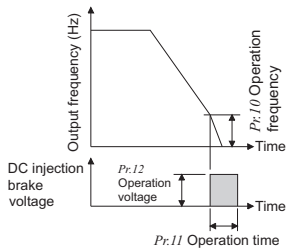

<i>Pr.12</i> Initial Value		When Using the Mitsubishi Constant Torque Motor	When Using the Energy Saving Motor
3.7K or less	4%	←	←
5.5K to 7.5K	4%	2% *	3%
11K or more	2%	←	←
75K or more	1%	←	←

\* If the *Pr. 71* initial value is changed to the setting for use with a constant-torque motor, the *Pr. 12* setting changes to the corresponding value in the above table.

**Pr. 13, 571 Starting frequency**

**Pr.13 Starting frequency** *Pr.571 Holding time at a start*

You can set the starting frequency and hold the set starting frequency for a certain period of time. Set these functions when you need the starting torque or want smooth motor drive at a start.

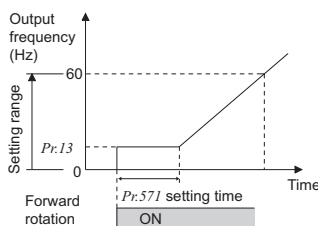

**Pr. 14 V/F pattern matching applications**

**Pr. 14 Load pattern selection**

You can select the optimum output characteristic (V/F characteristic) for the application and load characteristics.

**Setting "0"**  
For constant-torque load

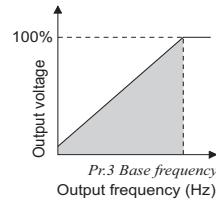

**Setting "1" (initial value)**  
For variable-torque load

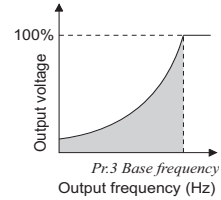

**Pr. 15, 16 Jog operation**

**Pr.15 Jog frequency**

**Pr.16 Jog acceleration/deceleration time**

You can set the frequency and acceleration/deceleration time for jog operation. Jog operation can be performed from either the outside or PU.

Can be used for conveyor positioning, test operation, etc.

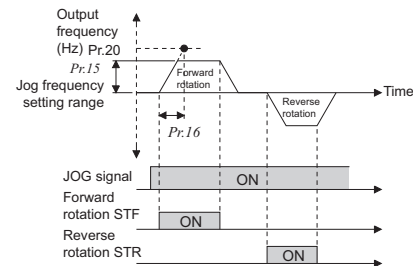

**Pr. 17 Logic selection of output stop signal (MRS)**

**Pr.17 MRS input selection**

The inverter output can be shut off by the MRS signal. The logic of the MRS signal can also be selected.

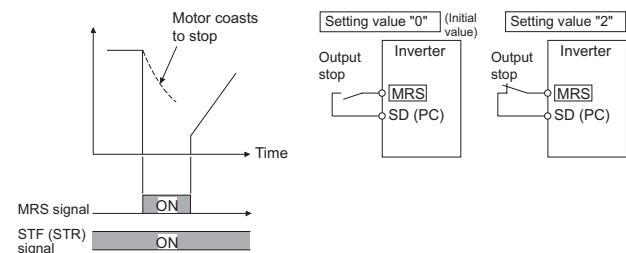

**Pr. 18** → Refer to the section about *Pr.1, Pr.2*

**Pr. 19** → Refer to the section about *Pr. 3*.

**Pr. 20, 21** → Refer to the section about *Pr.7, Pr.8*

**Pr.** 22, 23, 48, 49, 66, 148, 149, 154, 156, 157

**Stall prevention operation**

- Pr.22 Stall prevention operation level
- Pr.23 Stall prevention operation level compensation factor at double speed
- Pr.48 Second stall prevention operation current    Pr.49 Second stall prevention operation frequency
- Pr.66 Stall prevention operation reduction starting frequency
- Pr.148 Stall prevention level at 0V input.    Pr.149 Stall prevention level at 10V input.
- Pr.154 Voltage reduction selection during stall prevention operation
- Pr.156 Stall prevention operation selection    Pr.157 OL signal output timer

This function monitors the output current and automatically changes the output frequency to prevent the inverter from coming to an alarm stop due to overcurrent, overvoltage, etc. It can also limit stall prevention and fast-response current limit operation during acceleration/deceleration, driving or regeneration.

- Stall prevention  
If the output current exceeds the limit value, the output frequency of the inverter is automatically varied to reduce the output current. Also the second stall prevention function can restrict the output frequency range in which the stall prevention function is valid. (Pr.49)
- Fast-response current limit  
If the current exceeds the limit value, the output of the inverter is shut off to prevent an overcurrent.
- Set in Pr. 22 the ratio of the output current to the rated inverter current at which stall prevention operation will be performed. Normally set this parameter to 120% (initial value).
- When "9999" is set in Pr. 22, stall prevention operation level can be changed by the signal to the auxiliary input terminal (terminal 1). For the adjustment of bias/gain of analog signal, use Pr. 148 and Pr. 149.
- During high-speed operation above the rated motor frequency, acceleration may not be made because the motor current does not increase. If operation is performed in a high frequency range, the current at motor lockup becomes smaller than the rated output current of the inverter, and the protective function (OL) is not executed if the motor is at a stop.  
To improve the operating characteristics of the motor in this case, the stall prevention level can be reduced in the high frequency region. This function is effective for performing operation up to the high speed region on a centrifugal separator etc. Normally, set 60Hz in Pr. 66 and 100% in Pr. 23.
- By setting "9999" (initial value) in Pr. 23 Stall prevention operation level compensation factor at double speed, the stall prevention operation level is constant at the Pr. 22 setting up to 400Hz.

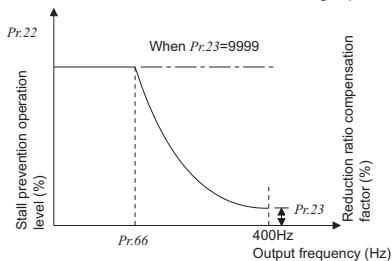

- Setting "9999" in Pr. 49 Second stall prevention operation frequency and turning the RT signal on make Pr. 48 Second stall prevention operation current valid.
- The stall prevention operation level from 0Hz to the output frequency set in Pr. 49 can be set in Pr. 48.

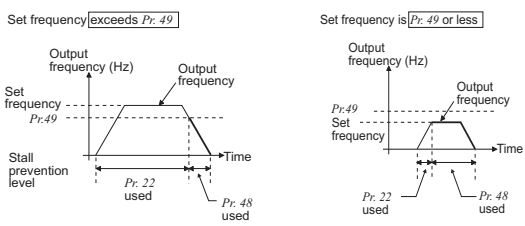

Pr. 49 Setting	Operation
0 (initial value)	Second stall prevention function is not activated
0.01Hz to 400Hz	If the output frequency is less than the frequency set in Pr. 49, the second stall prevention operation function is activated. (during constant speed or deceleration)
9999	The second stall prevention function is performed according to the RT signal. RT signal on ..... Stall level Pr. 48 RT signal off ..... Stall level Pr. 22

- Stall prevention operation and fast response current restriction function can be restricted according to the operation condition using Pr. 156.

**Pr.** 24 to 27 → Refer to the section about Pr.4 to Pr.6

**Pr.** 28 **Input compensation of multi-speed and remote setting**

Pr.28 Multi-speed input compensation selection

By inputting the frequency setting compensation signal (terminal 1, 2), the speed (frequency) can be compensated for relative to the multi-speed setting or the speed setting by remote setting function.

Pr. 28 Setting	Definition
0 (initial value)	Without compensation
1	With compensation

**Pr.** 29, 140 to 143 **Acceleration/ deceleration pattern and backlash measures**

- Pr.29 Acceleration/deceleration pattern selection    Pr.140 Backlash acceleration stopping frequency
- Pr.141 Backlash acceleration stopping time    Pr.142 Backlash deceleration stopping frequency
- Pr.143 Backlash deceleration stopping time

You can set the acceleration/deceleration pattern suitable for application. You can also set the backlash measures that stop acceleration/deceleration once at the parameter-set frequency and time during acceleration/deceleration.

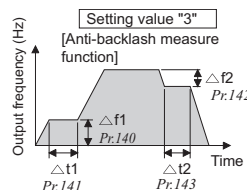
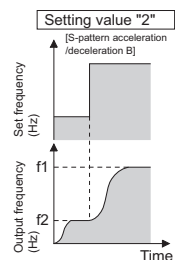
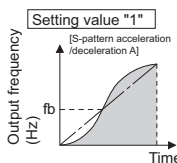
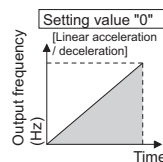

- Linear acceleration/deceleration (setting "0", initial value)
  - When the frequency is changed for acceleration, deceleration, etc. in inverter operation, the output frequency is changed linearly (linear acceleration/deceleration) to reach the set frequency without straining the motor and inverter.
- S-pattern acceleration/deceleration A (setting "1")
  - For machine tool spindle applications, etc. Use when acceleration/deceleration must be made in a short time to a high-speed region of not lower than base frequency.
- S-pattern acceleration/deceleration B (setting "2")
  - For prevention of load shifting in conveyor and other applications Since acceleration/deceleration is always made in an S shape from current frequency (f2) to target frequency (f1), this function eases shock produced at acceleration/ deceleration and is effective for load collapse prevention, etc.
- Backlash measures (setting "3", Pr.140 to Pr.143)
  - To avoid backlash, acceleration/ deceleration is temporarily stopped. Set the acceleration/deceleration stopping frequency and time in Pr. 140 to Pr. 143.

Features  
Peripheral Devices  
Why energy savings?  
Standard Specifications  
Outline Dimension Drawings  
Terminal Connection Diagram Terminal Specification Explanation  
Operation Panel  
Parameter List  
Explanations of Parameters  
Protective Functions  
Options  
Instructions  
Motor  
Compatibility  
Warranty  
Inquiry

## Pr. 30, 70 Selection of regeneration unit

**Pr.30 Regenerative function selection**    **Pr.70 Special regenerative brake duty \***

- Use the high power factor converter (FR-HC) to reduce harmonics, improve the power factor, or continuously use the regenerative mode.
- For the 75K or more, use the brake unit MT-BU5 or BR5 when the regenerative brake duty is need to be increased due to frequent starts and stops. Use the high power factor converter MT-HC to reduce harmonics, improve the power factor, or continuously use the regenerative mode.

<55K or less>

Pr.30 Setting	Regeneration Unit
0 (initial value)	Brake unit (FR-BU, BU)
2	High power factor converter (FR-HC), power regeneration common converter (FR-CV)

<75K or more>

Pr.30 Setting	Pr.70 Setting *	Regeneration Unit
0 (initial value)	—	Not used
1	0%	Power regeneration converter (MT-RC)
	10%	Brake unit (MT-BU5)
2	—	High power factor converter (MT-HC)

\* Pr.70 Special regenerative brake duty can be set for the 75K or more inverter.

## Pr. 31 to 36 Avoid mechanical resonance points (frequency jump)

**Pr.31 Frequency jump 1A**  
**Pr.33 Frequency jump 2A**  
**Pr.35 Frequency jump 3A**

**Pr.32 Frequency jump 1B**  
**Pr.34 Frequency jump 2B**  
**Pr.36 Frequency jump 3B**

When it is desired to avoid resonance attributable to the natural frequency of a mechanical system, these parameters allow resonant frequencies to be jumped.

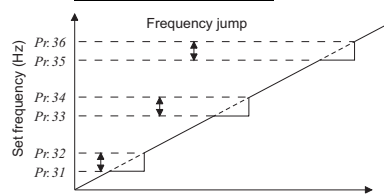

- Up to three areas may be set, with the jump frequencies set to either the top or bottom point of each area.
- The value set to 1A, 2A or 3A is a jump point and operation in the jump zone is performed at these frequencies.
- Frequency jump is not performed if the initial value is set to "9999".
- During acceleration/deceleration, the running frequency within the set area is valid.

## Pr. 37, 144 Speed display and speed setting

**Pr.37 Speed display**    **Pr.144 Speed setting switchover**

You can change the PU (FR-DU07) monitor display or frequency setting to motor speed or machine speed.

- When the running speed monitor is selected, each monitor and setting are determined according to the combination of Pr. 37 and Pr. 144. (The units within the thick frame are the initial values.)

Pr. 37 Setting	Pr. 144 Setting	Output Frequency Monitor	Set Frequency Monitor	Running Speed Monitor	Frequency Setting Parameter Setting
0	0	Hz	Hz	r/min *1	Hz
	2 to 10	Hz	Hz	r/min *1	Hz
	102 to 110	r/min *1	r/min *1	r/min *1	r/min *1
1 to 9998	0	Hz	Hz	Machine speed *1	Hz
	2 to 10	Machine speed *1	Machine speed *1	Machine speed *1	Machine speed *1
	102 to 110	Hz	Hz	r/min *1	Hz

- \*1 Motor speed r/min conversion formula  
..... Frequency × 120/number of motor poles (Pr. 144)  
Machine speed conversion formula  
..... Pr. 37 × frequency/60Hz  
For Pr. 144 in the above formula, the value is "Pr. 144-100" when "102 to 110" is set in Pr. 144 and the value is "4" when Pr. 37=0 and Pr.144=0.
- \*2 The increments for Hz are 0.01Hz, machine speed are 1m/min and r/min are 1r/min

## Pr. 41 to 43, 50 Detection of output frequency (SU, FU, FU2 signal)

**Pr.41 Up-to-frequency sensitivity**    **Pr.42 Output frequency detection**  
**Pr.43 Output frequency detection for reverse rotation**  
**Pr.50 Second output frequency detection**

The inverter output frequency is detected and output at the output signals.

- If the set frequency is considered as 100%, output frequency can be adjusted between ±1% and ±100% with Pr. 41.
- This parameter can be used to ensure that the running frequency has been reached to provide the operation start signal etc. for related equipment.

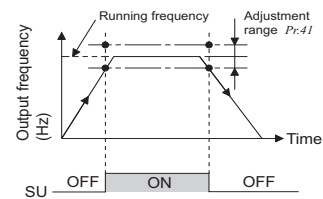

- When the output frequency reaches or exceeds the setting of Pr. 42, the output frequency detection signal (FU) is output. This function can be used for electromagnetic brake operation, open signal, etc.
- When the detection frequency is set in Pr. 43, frequency detection for reverse rotation use only can also be set. This function is effective for switching the timing of electromagnetic brake operation between forward rotation (rise) and reverse rotation (fall) during vertical lift operation, etc.
- When outputting a frequency detection signal besides the FU signal, set the detection frequency to Pr. 50. The FU2 signal is output when the output frequency reaches or exceeds the Pr. 50 setting.

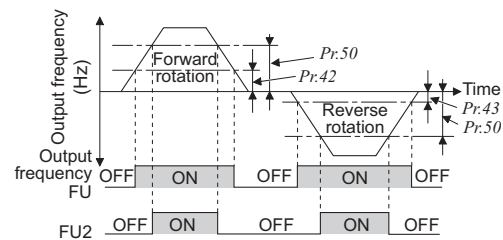

Pr. 44, 45 → Refer to the section about Pr.7, Pr.8

Pr. 46 → Refer to the section about Pr. 0.

Pr. 47 → Refer to the section about Pr. 3.

Pr. 48, 49 → Refer to the section about Pr. 22 and other relevant parameters.

Pr. 50 → Refer to the section about Pr. 41 and other relevant parameters.

Pr. 51 → Refer to the section about Pr. 9.

**Pr. 52, 54, 158, 170, 171, 268, 563, 564, 867, 891**

**Change of DU/PU monitor descriptions Cumulative monitor clear**

- Pr.52 DU/PU main display data selection    Pr.54 FM terminal function selection
- Pr.158 AM terminal function selection    Pr.170 Cumulative power meter clear
- Pr.171 Operation hour meter clear        Pr.268 Monitor decimal digits selection
- Pr.563 Energization time carrying-over times    Pr.564 Operating time carrying-over times
- Pr.867 AM output filter
- Pr.891 Cumulative power monitor digit shifted times

The monitor to be displayed on the main screen of the operation panel (FR-DU07) / parameter unit (FR-PU04) can be selected.

Types of Monitor	Increments	Pr.52 Parameter Setting Value		Pr.54 (FM) Pr.158 (AM) Setting	Full Scale Value
		DU LED	PU main monitor		
Output frequency	0.01Hz	0/100		1	Pr.55
Output current	0.01A/ 0.1A*6	0/100		2	Pr.56
Output voltage	0.1V	0/100		3	200V class : 400V 400V class : 800V
Alarm display	—	0/100		—	—
Frequency setting	0.01Hz	5	*1	5	Pr.55
Running speed	1(r/min)	6	*1	6	Value of Pr. 55 represented in terms of Pr. 37 value
Converter output voltage	0.1V	8	*1	8	200V class : 400V 400V class : 800V
Regenerative brake duty *5	0.1%	9	*1	9	Brake duty set in Pr. 30 and Pr. 70
Electronic thermal relay function load factor	0.1%	10	*1	10	Electronic thermal relay function operation level
Output current peak value	0.01A/ 0.1A*6	11	*1	11	Pr.56
Converter output voltage peak value	0.1V	12	*1	12	200V class : 400V 400V class : 800V
Input power	0.01kW/ 0.1kW*6	13	*1	13	Rated inverter power × 2
Output power	0.01kW/ 0.1kW*6	14	*1	14	Rated inverter power × 2
Input terminal status	—	—	*1	—	—
Output terminal status	—	55	*1	—	—
Option input terminal status	—	56	×	—	—
Option output terminal status	—	57	×	—	—
Load meter	0.1%	17		17	Pr.56
Reference voltage output	—	—	—	21	—
Cumulative energization time *2	1h	20		—	—
Actual operation time *2, 3	1h	23		—	—
Motor load factor	0.1%	24	—	24	200%
Cumulative power	0.01kWh/ 0.1kWh *4, *6	25	—	—	—
Power saving effect	Variable according to parameters	50	—	50	Inverter capacity
Cumulative saving power	—	51	—	—	—
PID set point	0.1%	52	—	52	100%
PID measured value	0.1%	53	—	53	100%
PID deviation value	0.1%	54	—	—	—

- \*1 Selected by the parameter unit(FR-PU04)
  - \*2 The cumulative energization time and actual operation time are accumulated from 0 to 65535 hours, then cleared, and accumulated again from 0.  
When the operation panel (FR-DU07) is used, up to 65.53 (65530h) is displayed as 1h=0.001 and then accumulated from 0.
  - \*3 The actual operation time is not added up if the cumulative operation time before power supply-off is less than 1h.
  - \*4 When using the parameter unit (FR-PU04), "kW" is displayed.
  - \*5 Setting can be made for the 75K or more.
  - \*6 The setting depends on the inverter capacity.(55K or less/75K or more).
- The cumulative power monitor value digit can be shifted to the right by the number set in Pr. 891.
  - By setting "0" in Pr. 170, the cumulative power monitor can be cleared.
  - You can check the numbers of cumulative energization time monitor exceeded 65535h with Pr. 563 and the numbers of actual operation time monitor exceeded 65535h with Pr. 564.
  - Writing "0" in Pr. 171 clears the actual operation time monitor.

Pr. 268 Setting	Description
9999 (initial value)	No function
0	When 1 or 2 decimal places (0.1 increments or 0.01 increments) are monitored, the decimal places are dropped and the monitor displays an integer value (1 increments). The monitor value of 0.99 or less is displayed as 0.
1	When 2 decimal places (0.01 increments) are monitored, the 0.01 decimal place is dropped and the monitor displays the first decimal place (0.1 increments). When the monitor display digit is originally in 1 increments, it is displayed unchanged in 1 increments.

- When Pr. 52 is set to "100", the set frequency monitor is displayed during a stop and the output frequency monitor is displayed during operation. (LED of Hz flickers during stop and is lit during operation.)

	Pr.52		
	0	100	
	During operation/stop	During stop	During running
Output frequency	Output frequency	Set frequency	Output frequency
Output current	Output current		
Output voltage	Output voltage		
Alarm display	Alarm display		

- Using Pr. 867, the output voltage response of the terminal AM can be adjusted within the range 0 to 5s.

**Pr. 55, 56 Change of the monitor output from terminal FM and AM**

Pr.55 Frequency monitoring reference    Pr.56 Current monitoring reference

Set the full-scale value to output the output frequency monitor value to terminal FM and AM.

Set the full-scale value to output the output current monitor value to terminal FM and AM in Pr. 56.

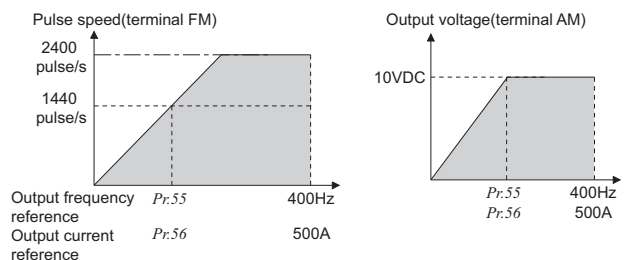

Features  
 Peripheral Devices Why energy savings?  
 Standard Specifications  
 Outline Dimension Drawings  
 Terminal Connection Diagram Terminal Specification Explanation  
 Operation Panel  
 Parameter List  
 Explanations of Parameters  
 Protective Functions  
 Options  
 Instructions  
 Motor  
 Compatibility  
 Warranty  
 Inquiry

**Pr. 57, 58, 162 to 165, 299, 611**

**Restart operation after instantaneous power failure / Flying start**

- Pr.57 Restart coasting time                      Pr.58 Restart cushion time
- Pr.162 Automatic restart after instantaneous power failure selection
- Pr.163 First cushion time for restart
- Pr.164 First cushion voltage for restart    Pr.165 Stall prevention operation level for restart
- Pr.299 Rotation direction detection selection at restarting
- Pr.611 Acceleration time at a restart

You can restart the inverter without stopping the motor in the following cases.

- when commercial power supply operation is switched to inverter operation
- when power comes back on after an instantaneous power failure
- when motor is coasting at start

Pr. Number	Setting Range	Description
57	0	1.5K or less.....0.5s, 2.2K to 7.5K.....1s, 11K or more .....3.0s 75K or more .....5.0s The above times are coasting time.
	0.1 to 5s/ 0.1 to 30s*	Set the waiting time for inverter-triggered restart after an instantaneous power failure.
	9999 (initial value)	No restart
58	0 to 60s	Set a voltage starting time at restart.
162	0 (initial value)	With frequency search
	1	Without frequency search (reduced voltage system)
	10	Frequency search at every start
	11	Reduced voltage system at every start
163	0 to 20s	Set a voltage starting time at restart.
164	0 to 100%	Consider using these parameters according to the load (inertia moment, torque) magnitude.
165	0 to 150%	Consider the rated inverter current as 100% and set the stall prevention operation level during restart operation.
	0	Without rotation direction detection
299	1	With rotation direction detection
	9999	When Pr: 78 =0, the rotation direction is detected. When Pr: 78 =1,2, the rotation direction is not detected.
	0	Without rotation direction detection
611	0 to 3600s	Set the acceleration time to reach the set frequency at restart.
	9999	Acceleration time for restart is the normal acceleration time (e.g. Pr: 7).

\* The setting range varies according to the inverter capacity. (55K or less/75K or more)

<Connection diagram>

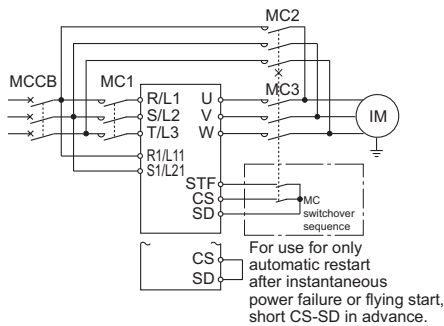

- When "0 (initial value) or 10" is set in Pr: 162, the inverter smoothly starts after detecting the motor speed upon power restoration.
- Even when the motor is rotating in the opposite direction, the inverter can be restarted smoothly as the direction of rotation is detected. (You can select whether to make rotation direction detection or not with Pr: 299 Rotation direction detection selection at restarting.)

When Pr: 162 = 0, 10 (with frequency search)

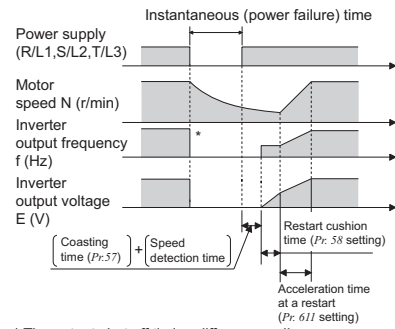

\* The output shut off timing differs according to the load condition.

- When Pr: 162 = "1" or "11", automatic restart operation is performed in a reduced voltage system, where the voltage is gradually risen with the output frequency unchanged from prior to an instantaneous power failure independently of the coasting speed of the motor.

When Pr: 162 = 1, 11 (without frequency search)

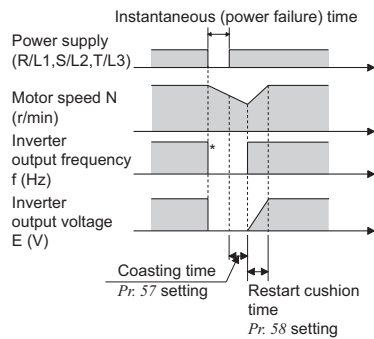

\* The output shut off timing differs according to the load condition.

**Pr. 59 Remote setting function**

Pr.59 Remote function selection

- Even if the operation panel is located away from the enclosure, you can use contact signals to perform continuous variable-speed operation, without using analog signals.
- By merely setting this parameter, you can use the acceleration, deceleration and setting clear functions of the motorized speed setter (FR-FK).

Pr.59 Setting	Description	
	RH, RM, RL signal function	Frequency setting storage function
0 (initial value)	Multi-speed setting	—
1	Remote setting	Yes
2	Remote setting	No
3	Remote setting	No (Turning STF/STR off clears remotely-set frequency.)

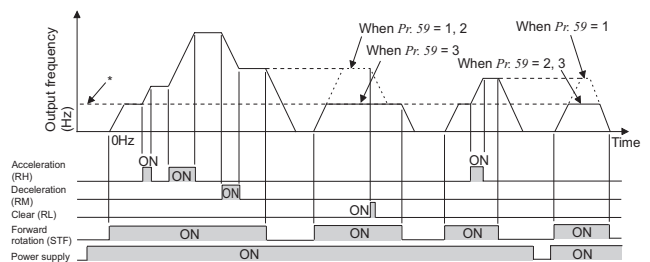

\* External running frequency (other than multi-speed operation) or PU running frequency



## Pr. 60 Energy saving control selection

### Pr.60 Energy saving control

Without a fine parameter setting, the inverter automatically performs energy saving operation.

This inverter is optimum for fan and pump applications.

Pr. 60 Setting	Description
0 (initial value)	Normal operation mode
4	Energy saving operation mode In the energy saving operation mode, the inverter automatically controls the output voltage to minimize the inverter output voltage during a constant operation.
9	Optimum excitation control mode The optimum excitation control mode is a control system which controls excitation current to improve the motor efficiency to maximum and determines output voltage as an energy saving system.

## Pr. 65, 67 to 69 Retry function at alarm occurrence

Pr.65 Retry selection

Pr.67 Number of retries at alarm occurrence

Pr.68 Retry waiting time

Pr.69 Retry count display erase

If an alarm occurs, the inverter resets itself automatically to restart. You can also select the alarm description for a retry. When selection of automatic restart after instantaneous power failure is selected (*Pr. 57 Restart coasting time*, restart operation is performed at retry operation as at an instantaneous power failure.)

- Use *Pr. 65* to select the alarm to be activated for retries. "●" indicates the alarms selected for retry.

Alarm Indication for Retry	Pr.65 Setting					
	0	1	2	3	4	5
E.OC1	●	●		●	●	●
E.OC2	●	●		●	●	
E.OC3	●	●		●	●	●
E.OV1	●		●	●	●	
E.OV2	●		●	●	●	
E.OV3	●		●	●	●	
E.THM	●					
E.THT	●					
E.IPF	●				●	
E.UVT	●				●	
E.BE	●				●	
E. GF	●				●	
E.OHT	●					
E.OLT	●				●	
E.OPT	●				●	
E.OP1	●				●	
E. PE	●				●	
E.PTC	●					
E.CDO	●				●	
E.SER	●				●	
E.ILF	●				●	

- Set the number of retries at alarm occurrence in *Pr. 67*.

Pr. 67 Setting	Description
0 (initial value)	No retry function
1 to 10	Set the number of retries at alarm occurrence. An alarm output is not provided during retry operation.
101 to 110	Set the number of retries at alarm occurrence. (The setting value of minus 100 is the number of retries.) An alarm output is provided during retry operation.

- Use *Pr. 68* to set the waiting time from when an inverter alarm occurs until a retry is made in the range 0 to 10s.
- Reading the *Pr. 69* value provides the cumulative number of successful restart times made by retry.

Pr. 66 → Refer to the section about *Pr. 22* and other relevant parameters.

Pr. 67 to 69 → Refer to the section about *Pr. 65* and other relevant parameters.

Pr. 70 → Refer to the section about *Pr. 30* and other relevant parameters.

## Pr. 71 Use the constant torque motor (applied motor)

Pr.71 Applied motor

Setting of the used motor selects the thermal characteristic appropriate for the motor.

Setting is necessary when using a constant-torque motor. Thermal characteristic of the electronic thermal relay function suitable for the motor is set.

Pr.71 Setting	Thermal Characteristic of the Electronic Thermal Relay Function	Motor (○: Motor used)	
		Standard (SF-JR, etc.)	Constant torque (SF-HRCA, etc.)
0 (initial value)	Thermal characteristics of a standard motor	○	
1	Thermal characteristics of the Mitsubishi constant-torque motor		○
2	Thermal characteristics of a standard motor Adjustable 5 points V/F	○	
20	Mitsubishi standard motor SF-JR4P (1.5kW or less)	○	

- For the 5.5K and 7.5K, the *Pr. 0 Torque boost* and *Pr. 12 DC injection brake operation voltage* settings are automatically changed according to the *Pr. 71* setting as follows.

Pr.71	Standard Motor Setting 0, 2, 20	Constant Torque Motor Setting 1
Pr. 0	3%	2%
Pr. 12	4%	2%

**Pr. 72, 240, 260**

**Carrier frequency and SoftPWM selection**

*Pr.72 PWM frequency selection*

*Pr.240 Soft-PWM operation selection*

*Pr.260 PWM frequency automatic switchover*

You can change the motor sound.

Pr. Number	Setting Range	Description
72	0 to 15/ 0 to 6, 25 *	You can change the PWM carrier frequency. The setting displayed is in [kHz]. Note that 0 indicates 0.7kHz, 15 indicates 14.5kHz and 25 indicates 2.5kHz.
240	0	Soft-PWM is invalid
	1	When "0 to 5" ("0 to 4" for the 75K or more) is set in Pr: 72, Soft-PWM is valid
260	0	PWM carrier frequency is constant independently of load. When the carrier frequency is set to 3kHz or more (Pr: 72 ≥ 3), perform continuous operation at less than 85% of the rated inverter current.
	1	Decreases PWM carrier frequency automatically when load increases.

\* The setting range varies according to the inverter capacity. (55K or less/75K or more).

(Note)When Pr: 260="1 (initial value)", if continuous operation is performed at 85% or more of the rated inverter current with Pr: 72 value set to "3" (3kHz) or more, the carrier frequency is automatically reduced. This may cause the motor noise to increase.

**Pr. 73, 242, 243, 252, 253, 267**

**Analog input selection**

*Pr.73 Analog input selection*

*Pr.242 Terminal 1 added compensation amount (terminal 2)*

*Pr.243 Terminal 1 added compensation amount (terminal 4)*

*Pr.252 Override bias*

*Pr.253 Override gain*

*Pr.267 Terminal 4 input selection*

- You can select the function that switches between forward rotation and reverse rotation according to the analog input polarity, the override function and the input signal specifications.
- For the terminals 1, 2, 4 used for analog input, voltage input (0 to 5V, 0 to 10V) or current input (4 to 20mA) can be selected.
- The additional compensation and fixed ratio of analog compensation (override) using terminal 2 as an auxiliary input can be made to multi-speed operation or the speed setting signal (main speed) of the terminal 2 or terminal 4. (   indicates the main speed setting)

Pr. 73 Setting	Terminal 2 Input	Terminal 1 Input	Terminal 4 Input	Compensation Input Terminal and Compensation Method	Polarity Reversible
0	0 to 10V	0 to ±10V	When the AU signal is off ×	Terminal 1 added compensation	Not function (Indicates that a frequency command signal of negative polarity is not accepted.)
1 (Initial value)	0 to 5V	0 to ±10V			
2	0 to 10V	0 to ±5V			
3	0 to 5V	0 to ±5V			
4	0 to 10V	0 to ±10V			
5	0 to 5V	0 to ±5V			
6	4 to 20mA	0 to ±10V			
7	4 to 20mA	0 to ±5V			
10	0 to 10V	0 to ±10V			
11	0 to 5V	0 to ±10V			
12	0 to 10V	0 to ±5V			
13	0 to 5V	0 to ±5V			
14	0 to 10V	0 to ±10V			
15	0 to 5V	0 to ±5V			
16	4 to 20mA	0 to ±10V			
17	4 to 20mA	0 to ±5V			

Pr. 73 Setting	Terminal 2 Input	Terminal 1 Input	Terminal 4 Input	Compensation Input Terminal and Compensation Method	Polarity Reversible
0	0 to 10V	0 to ±10V	When the AU signal is on According to the Pr: 267 setting (Initial value) 1:0 to 5V 2:0 to 10V	Terminal 1 added compensation	Not function (Indicates that a frequency command signal of negative polarity is not accepted.)
1 (Initial value)	×	0 to ±10V			
2	×	0 to ±5V			
3		0 to ±5V			
4	0 to 10V	×			
5	0 to 5V	×			
6	×	0 to ±10V			
7		0 to ±5V			
10	×	0 to ±10V			
11		0 to ±10V			
12		0 to ±5V			
13	0 to 10V	0 to ±5V			
14		0 to ±5V			
15	0 to 5V	×			
16	×	0 to ±10V			
17		0 to ±5V			

**(1) Added compensation (Pr:242, Pr:243)**

- A compensation signal can be added to the main speed setting for synchronous operation, etc.

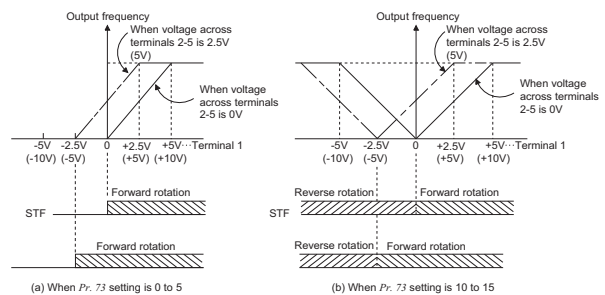

- The terminal 1 (frequency setting auxiliary input) signal is added to the main speed setting signal of the terminal 2 or 4.

**(2) Override function (Pr:252, Pr:253)**

- When an override is selected, the terminal 1 or 4 is used for the main speed setting and the terminal 2 for the override signal. (When the main speed of the terminal 1 or terminal 4 is not input, compensation by the terminal 2 is invalid.)

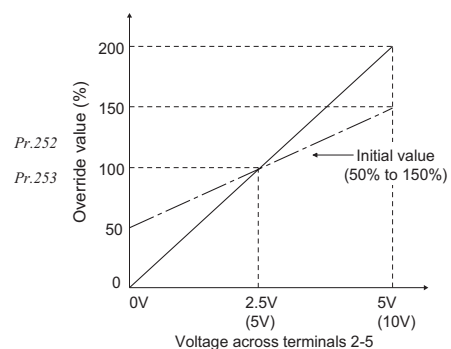

- When an override is selected, the terminal 1 or 4 is used for the main speed setting and the terminal 2 for the override signal (50% to 150% at 0 to 5V or 0 to 10V). (When the main speed of the terminal 1 or 4 is not input, compensation by the terminal 2 is invalid.)
- When Pr: 22 Stall prevention operation level = "9999", the value of the terminal 1 is as set to the stall prevention operation level.

## Pr. 74 Noise elimination at the analog input

### Pr.74 Input filter time constant



The time constant of the primary delay filter relative to external frequency command (analog input (terminal 1, 2, 4) signal) can be set.

- Valid for eliminating noise of the frequency setting circuit.
- Increase the filter time constant if steady operation cannot be performed due to noise.  
A larger setting results in slower response. (The time constant can be set between approximately 10ms to 1s with the setting of 0 to 8.)

## Pr. 75 Reset selection, disconnected PU detection

### Pr.75 Reset selection/disconnected PU detection/PU stop selection

You can select the reset input acceptance, disconnected PU (FR-DU07) connector detection function and PU stop function.

Pr. 75 Setting	Reset Selection	Disconnected PU Detection	PU Stop Selection
0	Reset input normally enabled.	If the PU is disconnected, operation will be continued as-is.	Pressing  decelerates the motor to a stop only in the PU operation mode.
1	Reset input enabled only when the protective function is activated.		
2	Reset input normally enabled.	When the PU is disconnected, the inverter output is shut off.	Pressing  decelerates the motor to a stop in any of the PU, external and communication operation modes.
3	Reset input enabled only when the protective function is activated.		
14 (initial value)	Reset input normally enabled.	If the PU is disconnected, operation will be continued as-is.	Pressing  decelerates the motor to a stop in any of the PU, external and communication operation modes.
15	Reset input enabled only when the protective function is activated.		
16	Reset input normally enabled.	When the PU is disconnected, the inverter output is shut off.	
17	Reset input enabled only when the protective function is activated.		

- Reset selection
  - You can select the operation timing of reset function (RES signal, reset command through communication) input
- Disconnected PU detection
  - This function detects that the PU (FR-DU07/FR-PU04) has been disconnected from the inverter for longer than 1s and causes the inverter to provide an alarm output (E.PUE) and come to an alarm stop.
- PU stop selection
  - In any of the PU operation, external operation and network operation modes, the motor can be stopped by pressing  of the PU.

## Pr. 76 Output function of alarm code

### Pr.76 Alarm code output selection

At alarm occurrence, its description can be output as a 4-bit digital signal from the open collector output terminals. The alarm code can be read by a programmable controller, etc., and its corrective action can be shown on a display, etc.

Pr. 76 Setting	Description
0 (initial value)	Without alarm code output
1	With alarm code output (Refer to the following table)
2	Alarm code output at alarm occurrence only (Refer to the following table)

- The following table indicates alarm codes to be output. (0: output transistor off, 1: output transistor on)

Operation Panel Indication (FR-DU07)	Output of Output Terminals				Alarm Code
	SU	IPF	OL	FU	
Normal *	0	0	0	0	0
E.OC1	0	0	0	1	1
E.OC2	0	0	1	0	2
E.OC3	0	0	1	1	3
E.OV1 to E.OV3	0	1	0	0	4
E.THM	0	1	0	1	5
E.THT	0	1	1	0	6
E.IPF	0	1	1	1	7
E.UVT	1	0	0	0	8
E.FIN	1	0	0	1	9
E.BE	1	0	1	0	A
E.GF	1	0	1	1	B
E.OHT	1	1	0	0	C
E.OLT	1	1	0	1	D
E.OPT	1	1	1	0	E
E.OP1	1	1	1	0	E
Other than the above	1	1	1	1	F

\* When Pr: 76 = "2", the output terminals output the signals assigned to Pr: 190 to Pr: 196.

## Pr. 77 Prevention of parameter rewrite

### Pr.77 Parameter write selection

You can select whether write to various parameters can be performed or not. Use this function to prevent parameter values from being rewritten by misoperation.

Pr. 77 Setting	Description
0 (initial value)	Write is enabled only during a stop
1	Parameter write is not enabled.
2	Parameter write is enabled in any operation mode regardless of operation status.

## Pr. 78 Prevention of reverse rotation of the motor

### Pr.78 Reverse rotation prevention selection













This function can prevent reverse rotation fault resulting from the incorrect input of the start signal.

Pr. 78 Setting	Description
0 (initial value)	Both forward and reverse rotations allowed
1	Reverse rotation disabled
2	Forward rotation disallowed

**Pr. 79 Pr. 340 Operation mode selection**

**Pr.79 Operation mode selection Pr.340 Communication startup mode selection**

- Used to select the operation mode of the inverter. You can freely change between operation by external signal (external operation), operation by PU (FR-DU07) (PU operation), operation by combination of PU operation and external operation (external/PU combined operation) and network operation (when RS-485 terminals or a communication option is used).

Pr. 79 Setting	Description	LED Indication :Off :On
0 (initial value)	External/PU switchover mode ( Press  to switch between the PU and external operation mode.) External operation mode at power-on	External operation mode  PU operation mode 
1	Fixed to PU operation mode	
2	Fixed to external operation mode Operation can be performed by switching between the external and Net operation mode.	External operation mode  NET operation mode 
3	External/PU combined operation mode 1	
	Running frequency      Start signal	
4	External/PU combined operation mode 2	
	Running frequency      Start signal	
6	Switch-over mode Switch among PU operation, external operation, and NET operation while keeping the same operation status.	PU operation mode  External operation mode  NET operation mode 
7	External operation mode (PU operation interlock) X12 signal ON Operation mode can be switched to the PU operation mode. (output stop during external operation) X12 signal OFF Operation mode can not be switched to the PU operation mode.	PU operation mode  External operation mode 

- Specify operation mode at power on (Pr.340)
  - When power is switched on or when power comes back on after instantaneous power failure, the inverter can be started up in the network operation mode.
  - After the inverter has started up in the network operation mode, parameter write and operation can be performed from a program.
  - Set this mode for communication operation using the inverter RS-485 terminals or communication option.
  - You can set the operation mode at power on (reset) according to the Pr. 79 and Pr. 340 settings.

Pr. 340 Setting	Pr. 79 Setting	Operation mode at Power On, Power Restoration, Reset	Operation Mode Switchover
0 (initial value)	As set in Pr. 79.		
1, 2 *1	0	NET operation mode	Can be switched to external, PU or NET operation mode *2
	1	PU operation mode	Fixed to PU operation mode
	2	NET operation mode	Can be switched to external or NET operation mode Switching to PU operation mode disabled
	3, 4	External/PU combined operation mode	Operation mode switching disabled
	6	NET operation mode	Can be switched to external, PU or NET operation mode with operation continued
	7	X12 (MRS) signal ON .. NET operation mode	Can be switched to external, PU or NET operation mode *2
		X12(MRS)signal OFF .. External operation mode	Fixed to external operation mode (Forcibly switched to external operation mode.)
10, 12 *1	0	NET operation mode	Can be switched to PU or NET operation mode *3
	1	PU operation mode	Fixed to PU operation mode
	2	NET operation mode	Fixed to NET operation mode
	3, 4	External/PU combined operation mode	Operation mode switching is disallowed
	6	NET operation mode	Can be switched to PU or NET operation mode with operation continued *3
	7	External operation mode	Fixed to external operation mode (Forcibly switched to external operation mode.)

\*1 The Pr. 340 setting "2" or "12" is mainly used for communication operation using the inverter RS-485 terminals. When a value other than "9999" (selection of automatic restart after instantaneous power failure) is set in Pr. 57 Restart coasting time, the inverter will resume the same operation state which was in before after power has been restored from an instantaneous power failure.

\*2 The operation mode cannot be switched directly between the PU operation mode and network operation mode.

\*3 Operation mode can be changed between the PU operation mode and network operation mode with  key of the operation panel (FR-DU07) and X65 signal.

**Pr. 80, 90 Simple magnetic flux vector control**

**Pr.80 Motor capacity (simple magnetic flux vector control)  
Pr.90 Motor constant (R1)**

- Providing optimum excitation to the motor can also produce high torque in a low-speed region. (simple magnetic flux vector control)
- Set the used motor capacity (equal to or one rank higher than the inverter capacity) in Pr. 80.
    - The number of motor poles should be any of 2, 4 and 6 poles.
    - Single-motor operation (one motor for one inverter)
    - Wiring length from inverter to motor should be within 30m.
  - When simple magnetic flux vector control is not used, set "9999" (initial value) in Pr. 80.
  - For Pr. 90 Motor constant (R1), normally setting is not necessary. When you need more torque under simple magnetic flux vector control for other manufacturer's motor, set the motor primary resistance value (R1) for Δ connection in Pr. 90

**Pr. 100 to 109**

**Adjustable 5 points V/F**

Pr.100 V/F1 (first frequency)

Pr.102 V/F2 (second frequency)

Pr.104 V/F3 (third frequency)

Pr.106 V/F4 (fourth frequency)

Pr.108 V/F5 (fifth frequency)

Pr.101 V/F1 (first frequency voltage)

Pr.103 V/F2 (second frequency voltage)

Pr.105 V/F3 (third frequency voltage)

Pr.107 V/F4 (fourth frequency voltage)

Pr.109 V/F5 (fifth frequency voltage)

A dedicated V/F pattern can be made by freely setting the V/F characteristic between a startup and the base frequency and base voltage under V/F control (frequency voltage/frequency). Possible to set the torque pattern that is optimum for the machine's characteristic

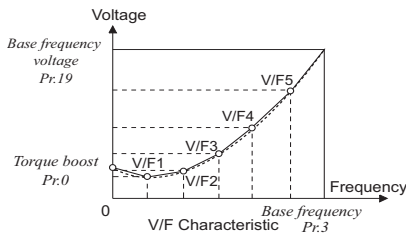

- Adjustable 5 points V/F will not function under simple magnetic flux vector control.
- When *Pr. 19 Base frequency voltage* = "8888" or "9999", *Pr. 71* cannot be set to "2". To set *Pr. 71* to "2", set the rated voltage value to *Pr. 19*
- When the frequency values of the points are the same, a write inhibit error (E<sub>r</sub>!) occurs.
- Set the points (frequencies, voltages) of *Pr. 100* to *Pr. 109* within the ranges of *Pr. 3 Base frequency* and *Pr. 19 Base frequency voltage*.
- When "2" is set in *Pr. 71*, *Pr. 47 Second V/F (base frequency)* will not function.
- When "2" is set in *Pr. 71*, thermal characteristic of the electronic thermal relay function changes to thermal characteristics of a standard motor.

**Pr. 117 to 124, 331 to 337, 341 to 343, 549**

**Communication initial setting**

Pr.117 PU communication station

Pr.118 PU communication speed

Pr.119 PU communication stop bit length

Pr.120 PU communication parity check

Pr.121 Number of PU communication retries

Pr.122 PU communication check time interval

Pr.123 PU communication waiting time setting

Pr.124 PU communication CR/LF presence/absence selection

Pr.331 RS-485 communication station

Pr.332 RS-485 communication speed

Pr.333 RS-485 communication stop bit length

Pr.334 RS-485 communication parity check selection

Pr.335 RS-485 communication number of retries

Pr.336 RS-485 communication check time interval

Pr.337 RS-485 communication waiting time setting

Pr.341 RS-485 communication CRLF selection

Pr.342 Communication EEPROM write selection

Pr.343 Communication error count

Pr.549 Protocol selection

**(1) Initial settings and specifications of RS-485 communication (Pr.117 to Pr.124, Pr.331 to Pr.337, Pr.341)**

Used to perform required settings for RS-485 communication between the inverter and personal computer.

- There are two different communications: communication using the PU connector of the inverter and communication using the RS-485 terminals.
- You can perform parameter setting, monitor, etc. using the Mitsubishi inverter protocol or Modbus-RTU protocol.
- To make communication between the personal computer and inverter, initialization of the communication specifications must be made to the inverter.  
Data communication cannot be made if the initial settings are not made or there is any setting error.

Pr. Number	Setting Range	Description
117 331	0 to 31 (0 to 247) *1	Specify the inverter station number. Set the inverter station numbers when two or more inverters are connected to one personal computer.
118 332	48, 96, 192, 384 (3, 6, 12, 24) *2	Set the communication speed. The setting value × 100 equals the communication speed. For example, the communication speed is 19200bps when the setting value is "192".
119 333		<b>Stop bit length</b>
	0	1bit
	1 (initial value)	2bit
	10	1bit
	11	2bit
		<b>Data length</b>
		8bit
		7bit
120 334	0	Without parity check
	1	With odd parity check
	2 (initial value)	With even parity check
121 335	0 to 10	Set the permissible number of retries at occurrence of a data receive error. If the number of consecutive errors exceeds the permissible value, the inverter will come to an alarm stop.
	9999	If a communication error occurs, the inverter will not come to an alarm stop.
122 336	0	No PU connector communication. Communication with RS-485 terminal can be made, but the inverter will come to an alarm stop in the NET operation mode.
	0.1 to 999.8s	Set the interval of communication check time. If a no-communication state persists for longer than the permissible time, the inverter will come to an alarm stop.
	9999 (initial value)	No communication check
123 337	0 to 150ms	Set the waiting time between data transmission to the inverter and response.
	9999 (initial value)	Set with communication data.
124 341	0	Without CR/LF
	1 (initial value)	With CR
	2	With CR/LF

\*1 When making communication through Modbus-RTU protocol with the RS-485 terminals, the setting range of *Pr. 331* within parenthesis is applied.  
\*2 The values in parenthesis are added to the setting range of *Pr. 332*.

**(2) Communication EEPROM write selection (Pr.342)**

Parameters written via the inverter's PU connector or RS-485 terminals or from the communication option can be written to the RAM. When performing parameter change frequently, set "1" in *Pr. 342*.

**(3) Modbus-RTU communication specifications (Pr.343, Pr.549)**

\* The Modbus-RTU protocol is valid for only communication from the RS-485 terminals.

Pr. Number	Setting Range	Description
343	—	Display the number of communication errors during Modbus-RTU communication. Reading only
549	0 (initial value)	Mitsubishi inverter (computer link) protocol
	1	Modbus-RTU protocol

**Pr. 125 Pr. 126 Pr. 241, C2(902) to C7(905)**

**Analog input frequency change and voltage, current input and frequency adjustment (calibration)**

**Pr.125 Terminal 2 frequency setting gain frequency**

**Pr.126 Terminal 4 frequency setting gain frequency**

- Pr. 241 Analog input display unit switchover
- C2(Pr.902) Terminal 2 frequency setting bias frequency
- C3(Pr.902) Terminal 2 frequency setting bias C4(Pr.903) Terminal 2 frequency setting gain
- C5(Pr.904) Terminal 4 frequency setting bias frequency
- C6(Pr.904) Terminal 4 frequency setting bias C7(Pr.905) Terminal 4 frequency setting gain

• You can set the magnitude (slope) of the output frequency as desired in relation to the frequency setting signal (0 to 5VDC, 0 to 10V or 4 to 20mA).

**(1) Change the frequency at maximum analog input. (Pr.125, Pr.126)**

Set a value in *Pr. 125 (Pr. 126)* when changing only the frequency setting (gain) of the maximum analog input power (current). (*C2 (Pr. 902) to C7 (Pr. 905)* setting need not be changed)

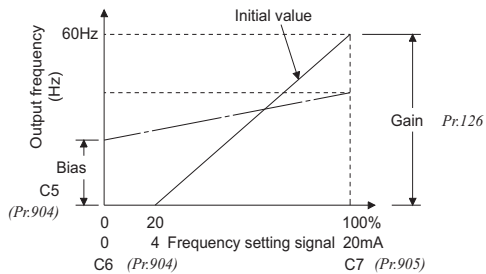
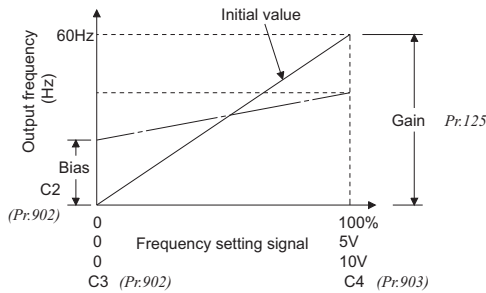

**(2) Analog input bias/gain calibration (C2(Pr.902) to C7(Pr.905))**

- The "bias" and "gain" functions are used to adjust the relationship between the input signal entered from outside the inverter to set the output frequency, e.g. 0 to 5V, 0 to 10V or 4 to 20mADC, and the output frequency.
- Set the bias frequency of terminal 2 input using *C2(Pr. 902)*. (Factory-set to the frequency at 0V)
- Using *Pr. 125*, set the output frequency relative to the frequency command voltage (current) set in *Pr. 73 Analog input selection*.
- Set the bias frequency of the terminal 4 input using *C5(Pr. 904)*. (Factory-set to the frequency at 4mA)
- Using *Pr. 126*, set the output frequency relative to 20mA of the frequency command current (4 to 20mA).

**(3) Analog input display unit changing (Pr. 241)**

- You can change the analog input display unit (%V/mA) for analog input bias/gain calibration.

**Pr. 127 to 134, 575 to 577 PID control**

- Pr.127 PID control automatic switchover frequency
- Pr.128 PID action selection
- Pr.130 PID integral time
- Pr.132 PID lower limit
- Pr.134 PID differential time
- Pr.576 Output interruption detection level
- Pr.129 PID proportional band
- Pr.131 PID upper limit
- Pr.133 PID action set point
- Pr.575 Output interruption detection time
- Pr.577 Output interruption release level

The inverter can be used to exercise process control, e.g. flow rate, air volume or pressure.

The terminal 2 input signal or parameter setting is used as a set point and the terminal 4 input signal used as a feedback value to constitute a feedback system for PID control.

• *Pr.128* = "10, 11" (Deviation value signal input)

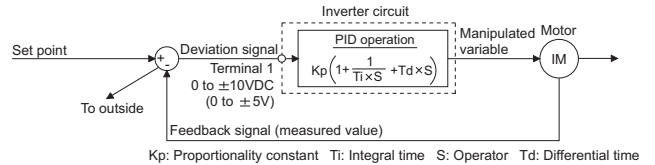

• *Pr.128* = "20, 21" (Measured value input)

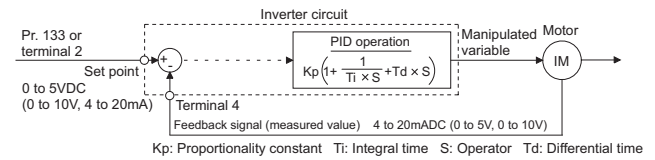

**Pr. 135 to 139, 159 Switch between the inverter operation and commercial power-supply operation to use**

- Pr.135 Commercial power-supply switchover sequence output terminal selection
- Pr.136 MC switchover interlock time
- Pr.137 Waiting time at a start
- Pr.138 Commercial power-supply operation switchover selection at an alarm
- Pr.139 Automatic switchover frequency between inverter and commercial power-supply operation
- Pr.159 Automatic switchover ON range between commercial power-supply and inverter operation

The complicated sequence circuit for commercial power supply-inverter switchover is built in the inverter. Hence, merely inputting the start, stop or automatic switchover selection signal facilitates the interlock operation of the switchover magnetic contactor.

Pr135 Setting	Description
0 (initial value)	Without commercial power-supply switchover sequence
1	With commercial power-supply switchover sequence

Sink logic type, *Pr.185* = "7", *Pr.192* = "17", *Pr.193* = "18", *Pr.194* = "19"

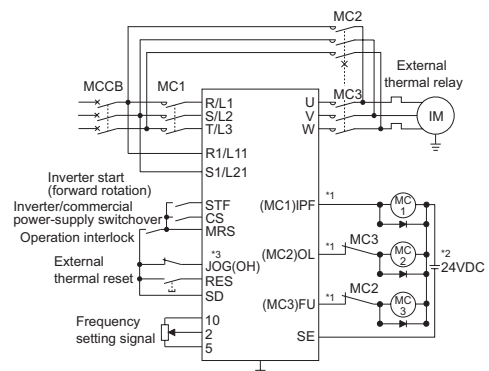

Commercial power-supply switchover sequence connection diagram

- \*1 Take caution for the capacity of the sequence output terminal.
- \*2 When connecting a DC power supply, insert a protective diode.
- \*3 The used terminal changes depending on the setting of *Pr. 180 to Pr. 189 (input terminal function selection)*.

**Pr. 140 to 143** → Refer to the section about *Pr. 29* and other relevant parameters.

**Pr. 144** → Refer to the section about *Pr. 37* and other relevant parameters.

**Pr. 145** Parameter unit display language selection

**Pr.145 PU display language selection**

You can switch the display language of the parameter unit (FR-PU04) to another.

Pr.145 Setting	Description
0 (initial value)	Japanese
1	English
2	German
3	French
4	Spanish
5	Italian
6	Swedish
7	Finnish

**Pr. 148, 149** → Refer to the section about Pr. 22 and other relevant parameters.

**Pr. 150 to 153, 166, 167**

**Detection of output current (Y12 signal) detection of zero current (Y13 signal)**

- Pr.150 Output current detection level    Pr.151 Output current detection signal delay time
- Pr.152 Zero current detection level    Pr.153 Zero current detection time
- Pr.166 Output current detection signal retention time
- Pr.167 Output current detection operation selection

The output current during inverter running can be detected and output to the output terminal.

**(1) Output current detection**

(Y12 signal, Pr. 150, Pr. 151, Pr. 166, Pr. 167)

- The output current detection function can be used for excessive torque detection, etc.
- If the output current remains higher than the Pr. 150 setting during inverter operation for longer than the time set in Pr. 151, the output current detection signal (Y12) is output from the inverter's open collector or relay output terminal.

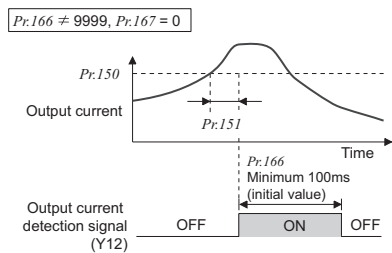

**(2) Zero current detection (Y13 signal, Pr. 152, Pr. 153)**

- If the output current remains lower than the Pr. 152 setting during inverter operation for longer than the time set in Pr. 153, the zero current detection (Y13) signal is output from the inverter's open collector or relay output terminal.

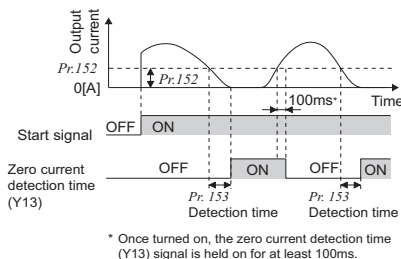

**Pr. 154** → Refer to the section about Pr. 22 and other relevant parameters.

**Pr. 155** Selection of action conditions of the second function signal (RT)

**Pr.155 RT signal reflection time selection**

You can select the second function using the external terminal (RT signal).

You can also set the RT signal operation condition (reflection time).

Pr.155 Setting	Description
0 (initial value)	This function is immediately made valid with on of the RT signal.
10	This function is valid only during the RT signal is on and constant speed operation. (invalid during acceleration/deceleration)

Functions that can be set as second functions

Function	First Function Parameter Number	Second Function Parameter Number
Torque boost	Pr.0	Pr.46
Base frequency	Pr.3	Pr.47
Acceleration time	Pr.7	Pr.44
Deceleration time	Pr.8	Pr.44, Pr.45
Electronic thermal O/L relay	Pr.9	Pr.51
Stall prevention	Pr.22	Pr.48, Pr.49

**Pr. 156, 157** → Refer to the section about Pr. 22 and other relevant parameters.

**Pr. 158** → Refer to the section about Pr. 54 and other relevant parameters.

**Pr. 159** → Refer to the section about Pr. 135 and other relevant parameters.

**Pr. 160 Pr. 172 to 174**

**Display of applied parameters and user group function**

**Pr.160 User group read selection**

- Pr.172 User group registered display/batch clear
- Pr.173 User group registration    Pr.174 User group clear

- Parameter which can be read from the operation panel and parameter unit can be restricted.

In the initial setting, only the simple mode parameters are displayed.

Pr. 160 Setting	Description
9999 (initial value)	Only the simple mode parameters can be displayed.
0	Simple mode+extended parameters can be displayed.
1	Only parameters registered to the user group can be displayed.

**(1) Display of simple mode parameters and extended parameters (Pr.160)**

- When Pr. 160 = "9999" (initial value), only the simple mode parameters can be displayed on the operation panel (FR-DU07) and parameter unit (FR-PU04).
- When "0" is set in Pr. 160, simple mode parameters and extended parameters can be displayed.

**(2) User group function (Pr.160, Pr.172 to Pr.174)**

- The user group function is designed to display only the parameters necessary for setting.
- From among all parameters, a maximum of 16 parameters can be registered to a user group. When Pr. 160 is set in "1", only the parameters registered to the user group can be accessed. (The parameters not registered to the user group cannot be read.)
- To register a parameter to the user group, set its parameter number to Pr. 173.
- To delete a parameter from the user group, set its parameter number to Pr. 174. To batch-delete the registered parameters, set Pr. 172 in "9999".

Features  
Peripheral Devices  
Why energy savings?  
Standard Specifications  
Outline Dimension Drawings  
Terminal Connection Diagram Terminal Specification Explanation  
Operation Panel  
Parameter List  
Explanations of Parameters  
Protective Functions  
Options  
Instructions  
Motor  
Compatibility  
Warranty  
Inquiry

## Pr. 161 Operation selection of the operation panel

### Pr.161 Frequency setting/key lock operation selection

You can use the setting dial of the operation panel (FR-DU07) like a potentiometer to perform operation.

The key operation of the operation panel can be disabled.

Pr.161 Setting	Description	
0 (initial value)	Setting dial frequency setting mode	Key lock mode invalid
1	Setting dial potentiometer mode	Key lock mode invalid
10	Setting dial frequency setting mode	Key lock mode valid
11	Setting dial potentiometer mode	Key lock mode valid

Pr. 162 to 165 → Refer to the section about Pr. 57 and other relevant parameters.

Pr. 166, 167 → Refer to the section about Pr. 150 and other relevant parameters.

Pr. 168, 169 Parameter for manufacturer setting. Do not set.

Pr. 170, 171 → Refer to the section about Pr. 52 and other relevant parameters.

Pr. 172 to 174 → Refer to the section about Pr. 160 and other relevant parameters.

## Pr. 178 to 189 Function assignment of input terminal

Pr.178 STF terminal function selection    Pr.179 STR terminal function selection  
 Pr.180 RL terminal function selection    Pr.181 RM terminal function selection  
 Pr.182 RH terminal function selection    Pr.183 RT terminal function selection  
 Pr.184 AU terminal function selection    Pr.185 JOG terminal function selection  
 Pr.186 CS terminal function selection    Pr.187 MRS terminal function selection  
 Pr.188 STOP terminal function selection    Pr.189 RES terminal function selection

Use these parameters to select/change the input terminal functions.

Pr.178 to Pr.189 Setting	Signal Name	Function	
0	RL	Pr.59 = 0 (initial value)	Low speed operation command
		Pr.59 = 1, 2 *1	Remote setting (setting clear)
1	RM	Pr.59 = 0 (initial value)	Middle speed operation command
		Pr.59 = 1, 2 *1	Remote setting (deceleration)
2	RH	Pr.59 = 0 (initial value)	High speed operation command
		Pr.59 = 1, 2 *1	Remote setting (acceleration)
3	RT	Second function selection	
4	AU	Terminal 4 input selection	
5	JOG	Jog operation selection	
6	CS	Selection of automatic restart after instantaneous power failure, flying start	
7	OH	External thermal relay input *2	
8	REX	15 speed selection (combination with three speeds RL, RM, RH)	
10	X10	Inverter operation enable signal (FR-HC, FR-CV connection)	
11	X11	FR-HC connection, instantaneous power failure detection	
12	X12	PU operation external interlock	
14	X14	PID control valid terminal	
16	X16	PU-external operation switchover	
24	MRS	Output stop	
25	STOP	Start self-holding selection	
60	STF	Forward rotation command (assigned to STF terminal (Pr. 178) only)	
61	STR	Reverse rotation command (assigned to STR terminal (Pr. 179) only)	
62	RES	Inverter reset	
63	PTC	PTC thermistor input (assigned to AU terminal (Pr. 184) only)	
64	X64	PID forward/reverse action switchover	
65	X65	NET/PU operation switchover	
66	X66	External/NET operation switchover	
67	X67	Command source switchover	
9999	—	No function	

\*1 When Pr. 59 Remote function selection = "1" or "2", the functions of the RL, RM and RH signals are changed as given in the table.

\*2 The OH signal turns on when the relay contact "opens".

## Pr. 190 to 196 Terminal assignment of output terminal

Pr.190 RUN terminal function selection    Pr.191 SU terminal function selection  
 Pr.192 IPF terminal function selection    Pr.193 OL terminal function selection  
 Pr.194 FU terminal function selection    Pr.195 ABC1 terminal function selection  
 Pr.196 ABC2 terminal function selection

You can change the functions of the open collector output terminal and relay output terminal.

Pr.190 to Pr.196 Setting		Signal Name	Function
Positive logic	Negative logic		
0	100	RUN	Inverter running
1	101	SU	Up to frequency
2	102	IPF	Instantaneous power failure/ undervoltage
3	103	OL	Overload alarm
4	104	FU	Output frequency detection
5	105	FU2	Second output frequency detection
5	105	FU2	Second output frequency detection
7	107	RBP	Regenerative brake prealarm *
10	110	PU	PU operation mode
11	111	RY	Inverter operation ready
12	112	Y12	Output current detection
13	113	Y13	Zero current detection
14	114	FDN	PID lower limit
15	115	FUP	PID upper limit
16	116	RL	PID forward/reverse rotation output
17	—	MC1	Commercial power-supply switchover MC1
18	—	MC2	Commercial power-supply switchover MC2
19	—	MC3	Commercial power-supply switchover MC3
25	125	FAN	Fan fault output
26	126	FIN	Heatsink overheat pre-alarm
45	145	RUN3	During inverter running and start command is on
46	146	Y46	During deceleration at occurrence of power failure (retained until release)
47	147	PID	During PID control activated
64	164	Y64	During retry
70	170	SLEEP	During PID output suspension
90	190	Y90	Life alarm
91	191	Y91	Alarm output 3 (power-off signal)
92	192	Y92	Energy saving average value updated timing
93	193	Y93	Current average monitor signal
94	194	ALM2	Alarm output 2
95	195	Y95	Maintenance timer signal
96	196	REM	Remote output
98	198	LF	Minor fault output
99	199	ALM	Alarm output
9999		—	No function

\* Setting can be made for the 75K or more.

Pr. 232 to 239 → Refer to the section about Pr.4 to Pr.6

Pr. 240 → Refer to the section about Pr. 72 and other relevant parameters.

Pr. 241 → Refer to the section about Pr. 125, Pr.126

Pr. 242, 243 → Refer to the section about Pr. 73 and other relevant parameters.



### Pr. 244 Increase cooling fan life

**Pr.244 Cooling fan operation selection**

You can control the operation of the cooling fan (200V class 2.2K or more, 400V class 3.7K or more) built in the inverter.

Pr. 244 Setting	Description
0	The cooling fan operates at power on. Cooling fan on/off control invalid (The cooling fan is always on at power on)
1 (initial value)	Cooling fan on/off control valid. The fan is normally on during inverter operation. The fan switches on/off according to the temperature during a stop of the inverter whose status is monitored.

### Pr. 245 to 247 Slip compensation

**Pr.245 Rated slip**

**Pr.246 Slip compensation time constant**

**Pr.247 Constant-output region slip compensation selection**

The inverter output current may be used to assume motor slip to keep the motor speed constant.

### Pr. 250 Selection of motor stopping method and start signal

**Pr.250 Stop selection**

Used to select the stopping method (deceleration to a stop or coasting) when the start signal turns off.

Used to stop the motor with a mechanical brake, etc. together with switching off of the start signal.

You can also select the operations of the start signals (STF/STR).

Pr.250 Setting	Description	
	Start signal (STF/STR)	Stop operation
0 to 100s	STF signal: Forward rotation start STR signal: Reverse rotation start	The motor is coasted to a stop when the preset time elapses after the start signal is turned off. The motor is coasted to a stop (Pr. 250 - 1000)s after the start signal is turned off.
1000s to 1100s	STF signal: Start signal STR signal: Forward/reverse rotation signal	
9999	STF signal: Forward rotation start STR signal: Reverse rotation start	When the start signal is turned off, the motor decelerates to stop.
8888	STF signal: Start signal STR signal: Forward/reverse rotation signal	

When Pr. 250 is set to "9999" (initial value) or "8888".

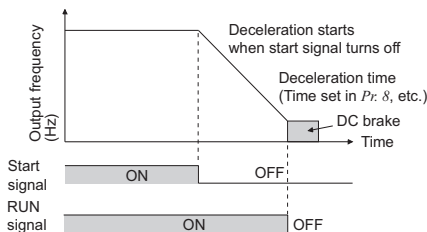

When Pr. 250 is set to values other than "9999" (initial value) or "8888".

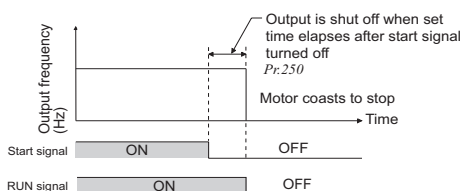

### Pr. 251, 872 Input/output phase failure protection selection

**Pr.251 Output phase failure protection selection**

**Pr.872 Input phase failure protection selection**

You can disable the output phase failure protection function that stops the inverter output if one of the inverter output side (load side) three phases (U, V, W) opens.

The input phase failure protection selection of the inverter input side (R/L1, S/L2, T/L3) can be made valid.

Pr. Number	Setting Range	Description
251	0	Without output phase failure protection
	1 (initial value)	With output phase failure protection
872	0 (initial value)	Without input phase failure protection
	1	With input phase failure protection

**Pr. 252, 253**

→ Refer to the section about Pr. 73 and other relevant parameters.

### Pr. 255 to 259 Display of the life of the inverter parts

**Pr.255 Life alarm status display**

**Pr.256 Inrush current limit circuit life display**

**Pr.257 Control circuit capacitor life display**

**Pr.258 Main circuit capacitor life display**

**Pr.259 Main circuit capacitor life measuring**

Degrees of deterioration of main circuit capacitor, control circuit capacitor or inrush current limit circuit and cooling fan can be diagnosed by monitor.

When any part has approached the end of its life, an alarm can be output by self diagnosis to prevent a fault.

(Use the life check of this function as a guideline since the life except the main circuit capacitor is calculated theoretically.)

Pr. Number	Setting Range	Description
255	(0 to 15)	Display whether the control circuit capacitor, main circuit capacitor, cooling fan, and each parts of the inrush current limit circuit has reached the life alarm output level or not. Reading only
256	(0 to 100%)	Display the deterioration degree of the inrush current limit circuit. Reading only
257	(0 to 100%)	Display the deterioration degree of the control circuit capacitor. Reading only
258	(0 to 100%)	Display the deterioration degree of the main circuit capacitor. Reading only. The value measured by Pr. 259 is displayed.
259	0, 1 (2, 3, 8, 9)	Setting "1" and turning off the power starts the measurement of the main circuit capacitor life. When the Pr. 259 value is "3" after powering on again, the measuring is completed. Read the deterioration degree in Pr. 258.

**Pr. 260**

→ Refer to the section about Pr. 72.

**Pr. 261 to 266 Operation at instantaneous power failure**

- Pr.261 Power failure stop selection
- Pr.262 Subtracted frequency at deceleration start
- Pr.263 Subtraction starting frequency    Pr.264 Power-failure deceleration time 1
- Pr.265 Power-failure deceleration time 2
- Pr.266 Power failure deceleration time switchover frequency

When a power failure or undervoltage occurs, the inverter can be decelerated to a stop or can be decelerated and re-accelerated to the set frequency.

Pr. Number	Setting Range	Description
261	0 (initial value)	Coasting to stop When undervoltage or power failure occurs, the inverter output is shut off.
	1	When undervoltage or a power failure occurs, the inverter can be decelerated to a stop.
	2	When undervoltage or a power failure occurs, the inverter can be decelerated to a stop. If power is restored during a power failure, the inverter accelerates again.
262	0 to 20Hz	Normally operation can be performed with the initial value unchanged. But adjust the frequency according to the magnitude of the load specifications (moment of inertia, torque).
263	0 to 120Hz	When output frequency $\geq$ Pr. 263 Decelerate from the speed obtained from output frequency minus Pr. 262. When output frequency $<$ Pr. 263 Decelerate from output frequency
	9999	Decelerate from the speed obtained from output frequency minus Pr. 262.
264	0 to 3600/ 360s *	Set a deceleration slope down to the frequency set in Pr. 266.
265	0 to 3600/ 360s *	Set a deceleration slope below the frequency set in Pr. 266.
	9999	Same slope as in Pr. 264
266	0 to 400Hz	Set the frequency at which the deceleration slope is switched from the Pr. 264 setting to the Pr. 265 setting.

\* When the setting of Pr. 21 Acceleration/deceleration time increments is "0" (initial value), the setting range is "0 to 3600s" and the setting increments are "0.1s", and when the setting is "1", the setting range is "0 to 360s" and the setting increments are "0.01s"

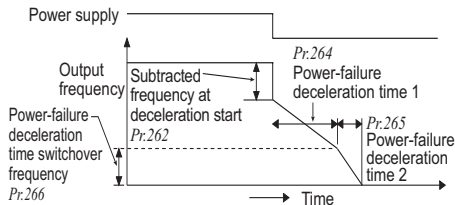

**(1) Power failure stop mode (Pr.261 = "1")**

If power is restored during power failure deceleration, deceleration to a stop is continued and the inverter remains stopped. To restart, turn off the start signal once, then turn it on again.

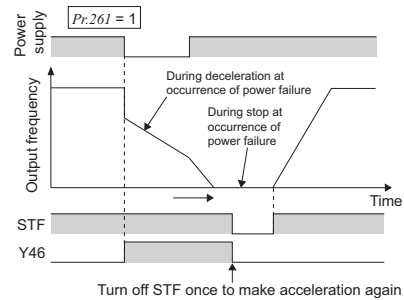

**(2) Instantaneous power failure-time operation continuation function (Pr.261 = "2")**

When power is restored during deceleration after an instantaneous power failure, acceleration is made again up to the set frequency.

When this function is used in combination with the automatic restart after instantaneous power failure operation, deceleration can be made at a power failure and acceleration can be made again after power restoration.

When power is restored after a stop by deceleration at an instantaneous power failure, automatic restart operation is performed if automatic restart after instantaneous power failure has been selected (Pr. 57  $\neq$  "9999")

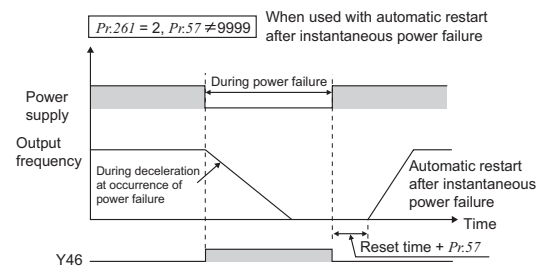
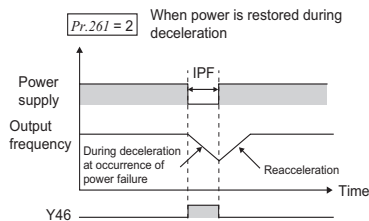

- Pr. 267** → Refer to the section about Pr. 73 and other relevant parameters.
- Pr. 268** → Refer to the section about Pr. 52 and other relevant parameters.
- Pr. 269** Parameter for manufacturer setting. Do not set.
- Pr. 299** → Refer to the section about Pr. 57 and other relevant parameters.
- Pr. 331 to 337** → Refer to the section about Pr. 117 and other relevant parameters.

**Pr.** 338, 339, 550, 551

**Operation command source and speed command source during communication operation**

- Pr.338 Communication operation command source
- Pr.339 Communication speed command source
- Pr.550 NET mode operation command source selection
- Pr.551 PU mode operation command source selection

When the RS-485 terminals or communication option is used, the external operation command and speed command can be made valid. Also, the control command source in the PU operation mode can be selected.

Pr. Number	Setting Range	Description
338	0 (initial value)	Operation command source communication
	1	Operation command source external
339	0 (initial value)	Speed command source communication
	1	Speed command source external (Frequency setting from communication is invalid, terminal 2 and 1 setting from external is valid)
	2	Speed command source external (Frequency setting from communication is valid, terminal 2 and 1 setting from external is invalid)
550 *	0	Communication option valid
	1	Inverter RS-485 terminal valid
551 *	9999 (initial value)	Automatic communication option recognition Normally, the RS-485 terminals are valid. When the communication option is fitted, the communication option is valid.
	1	Select the RS-485 terminals as the PU operation mode control source.
551 *	2 (initial value)	Select the PU connector as the PU operation mode control source.

\* Pr. 550 and Pr. 551 are always write-enabled.

- Pr.** 340 → Refer to the section about Pr. 79.
- Pr.** 341 to 343 → Refer to the section about Pr. 117 and other relevant parameters.

**Pr.** 495 to 497 **Remote output function (REM signal)**

- Pr.495 Remote output selection      Pr.496 Remote output data 1
- Pr.497 Remote output data 2

You can utilize the on/off of the inverter's output signals instead of the remote output terminal of the programmable logic controller.

**Pr.** 503 to 504 **To determine the maintenance time of parts.**

- Pr.503 Maintenance timer      Pr.504 Maintenance timer alarm output set time

When the cumulative energization time of the inverter reaches the parameter set time, the maintenance timer output signal (Y95) is output. MT (MT) is displayed on the operation panel (FR-DU07)

This can be used as a guideline for the maintenance time of peripheral devices.

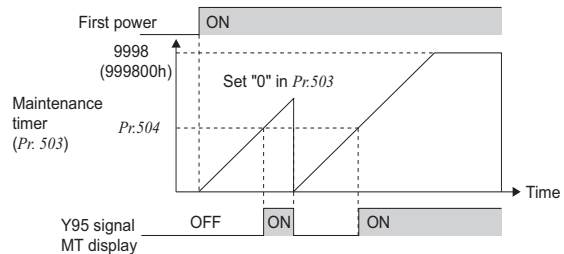

- The cumulative energization time of the inverter is stored into the EEPROM every hour and indicated in Pr. 503 Maintenance timer in 100h increments. Pr. 503 is clamped at 9998 (999800h).

- Pr.** 549 → Refer to the section about Pr.117 to Pr. 124.
- Pr.** 550 to 551 → Refer to the section about Pr. 338, Pr.339.

**Pr.** 555 to 557 **Current average value monitor signal**

- Pr.555 Current average time      Pr.556 Data output mask time
- Pr.557 Current average value monitor signal output reference current

The average value of the output current during constant speed operation and the maintenance timer value are output as a pulse to the current average value monitor signal (Y93).

The pulse width output to the I/O module of the PLC or the like can be used as a guideline due to abrasion of machines and elongation of belt and for aged deterioration of devices to know the maintenance time.

The current average value monitor signal (Y93) is output as pulse for 20s as 1 cycle and repeatedly output during constant speed operation.

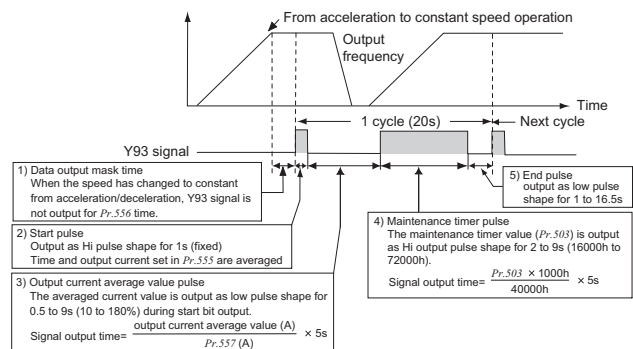

- Pr.** 571 → Refer to the section about Pr. 13 and other relevant parameters.
- Pr.** 575 to 577 → Refer to the section about Pr. 127 and other relevant parameters.
- Pr.** 611 → Refer to the section about Pr. 57 and other relevant parameters.
- Pr.** 872 → Refer to the section about Pr. 251 and other relevant parameters.

**Pr.** 882 to 886 **Regeneration avoidance function**

Pr.882 Regeneration avoidance operation selection

Pr.883 Regeneration avoidance operation level

Pr.884 Regeneration avoidance at deceleration detection sensitivity

Pr.885 Regeneration avoidance compensation frequency limit value

Pr.886 Regeneration avoidance voltage gain

This function detects a regeneration status and increases the frequency to avoid the regeneration status.

- Possible to avoid regeneration by automatically increasing the frequency and continue operation if the fan happens to rotate faster than the set speed due to the effect of another fan in the same duct.

Pr. Number	Setting Range	Description
882	0 (initial value)	Regeneration avoidance function invalid
	1	Regeneration avoidance function valid
883	300 to 800V	Set the bus voltage level at which regeneration avoidance operates. When the bus voltage level is set to low, overvoltage error will be less apt to occur. However, the actual deceleration time increases. The set value must be higher than the power supply voltage $\times \sqrt{2}$ .
884	0 (initial value)	Regeneration avoidance by bus voltage change ratio is invalid
	1 to 5	Set sensitivity to detect the bus voltage change Setting 1 $\longrightarrow$ 5 Detection sensitivity low $\longrightarrow$ high
885	0 to 10Hz	Set the limit value of frequency which rises at activation of regeneration avoidance function.
	9999	Frequency limit invalid
886	0 to 200%	Adjust responsiveness at activation of regeneration avoidance. A larger setting will improve responsiveness to the bus voltage change. However, the output frequency could become unstable.

**Pr.** 888, 889 **Free parameter**

Pr.888 Free parameter 1

Pr.889 Free parameter 2

Parameters you can use for your own purposes.

You can input any number within the setting range 0 to 9999.

For example, the number can be used:

- As a unit number when multiple units are used.
- As a pattern number for each operation application when multiple units are used.
- As the year and month of introduction or inspection.

**Pr.** 891  $\rightarrow$  Refer to the section about Pr. 52 and other relevant parameters.

**Pr.** 892 to 899 **Energy saving monitor**

Pr.892 Load factor

Pr.893 Energy saving monitor reference (motor capacity)

Pr.894 Control selection during commercial power-supply operation

Pr.895 Power saving rate reference value

Pr.896 Power unit cost

Pr.897 Power saving monitor average time

Pr.898 Power saving cumulative monitor clear

Pr.899 Operation time rate (estimated value)

From the power consumption estimated value during commercial power supply operation, the energy saving effect by use of the inverter can be monitored/output.

The following provides the items that can be monitored by the power saving monitor (Pr. 52, Pr. 54, Pr. 158 = "50").

(Only power saving and power saving average value can be output to Pr. 54 (terminal FM) and Pr. 158 (terminal AM))

Energy Saving Monitor Item	Description and Formula	Increments
Power saving	Difference between the estimated value of power necessary for commercial power supply operation and the input power calculated by the inverter <b>Power during commercial power supply operation - input power monitor</b>	0.01kW/ 0.1kW*
Power saving rate	Ratio of power saving on the assumption that power during commercial power supply operation is 100%  <b>Power saving</b> $\frac{\text{Power during commercial power supply operation}}{\text{Power during commercial power supply operation}} \times 100$	0.1%
	Ratio of power saving on the assumption that Pr. 893 is 100%  <b>Power saving</b> $\frac{\text{Pr.893}}{\text{Pr.893}} \times 100$	
Power saving average value	Average value of power saving amount per hour during predetermined time (Pr. 897)  $\frac{\Sigma (\text{Power saving} \times \Delta t)}{\text{Pr.897}}$	0.01kWh/ 0.1kWh*
Power saving rate reference value	Ratio of power saving average value on the assumption that the value during commercial power supply operation is 100%  $\frac{\Sigma (\text{Power saving} \times \Delta t)}{\text{Pr.897}} \times 100$	0.1%
	Ratio of power saving average value on the assumption that Pr. 893 is 100%  <b>Power saving average value</b> $\frac{\text{Pr.893}}{\text{Pr.893}} \times 100$	
Power saving charge average value	Power saving average value represented in terms of charge <b>Power saving average value <math>\times</math> Pr. 896</b>	0.01/0.1*

The following gives the items which can be monitored by the cumulative saving power monitor (Pr. 52 = "51").  
(The cumulative power monitor data digit can be shifted to the right by the number set in Pr. 891 Cumulative power monitor digit shifted times.)

Energy Saving Monitor Item	Description and Formula	Increments
Power saving amount	Power saving is added up per hour. $\Sigma (\text{Power saving} \times \Delta t)$	0.01kWh/ 0.1kWh*
Power saving amount charge	Power saving amount represented in terms of charge $\text{Power saving amount} \times \text{Pr. 896}$	0.01/0.1*
Annual power saving amount	Estimated value of annual power saving amount $\frac{\text{Power saving amount}}{\text{Operation time during power saving totalization}} \times 24 \times 365 \times \frac{\text{Pr. 899}}{100}$	0.01kWh/ 0.1kWh*
Annual power saving amount charge	Annual power saving amount represented in terms of charge $\text{Annual power saving amount} \times \text{Pr. 896}$	0.01/0.1*

\* The increments vary according to the inverter capacity. (55K or less/75K or more)

### Pr. C0(900), C1(901) Adjustment of terminal FM and AM (calibration)

C0(Pr.900) FM terminal calibration      C1(Pr.901) AM terminal calibration

The operation panel and parameter unit can be used to calibrate the full scales of the terminals FM and AM.

#### (1) FM terminal calibration (C0(Pr.900))

- The terminal FM is preset to output pulses. By setting the Calibration parameter C0 (Pr. 900), the meter connected to the inverter can be calibrated by parameter setting without use of a calibration resistor.
- Using the pulse train output of the terminal FM, a digital display can be provided by a digital counter. The monitor value is 1440 pulses/s output at the full-scale value of Pr. 54 FM terminal function selection.

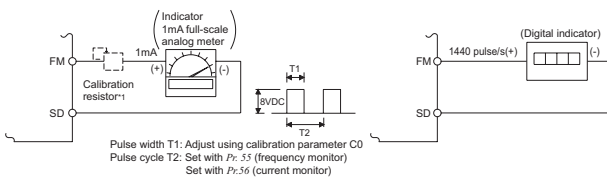

\*1 Not needed when the operation panel (FR-DU07) or parameter unit (FR-PU04) is used for calibration. Used when calibration must be made near the frequency meter for such a reason as a remote frequency meter. However, the frequency meter needle may not deflect to full-scale if the calibration resistor is connected. In this case, use this resistor and operation panel or parameter unit together.

#### (2) AM terminal calibration (C1(Pr.901))

- The AM terminal is factory-set to output 10VDC in the full-scale state of each monitor item. By setting the calibration parameter C1 (Pr. 901), the ratio (gain) of the output voltage can be adjusted to the meter scale. Note that the maximum output voltage is 10VDC.

Pr. C2(902) to C7(905) → Refer to the section about Pr. 125, Pr. 126

Pr. 989 Parameter for manufacturer setting. Do not set.

### Pr. 990 Buzzer control of the operation panel

Pr.990 PU buzzer control

You can make the buzzer "beep" when you press key of the operation panel (FR-DU07) and parameter unit (FR-PU04).

Pr.990 Setting	Description
0	Without buzzer
1(initial value)	With buzzer

### Pr. 991 PU contrast adjustment

Pr.991 PU contrast adjustment

Contrast adjustment of the LCD of the parameter unit (FR-PU04) can be performed.

Decreasing the setting value makes contrast light.

Pr.991 Setting	Description
0 to 63	0 : Light ↓ 63 : Dark

### Pr. 989, CL, ALLC, Er.CL, PCPY

#### Parameter clear, parameter copy

Pr.989 Parameter copy alarm release

Pr.CL Parameter clear

Er.CL Alarm history clear

ALLC All parameter clear

PCPY Parameter copy

- Set "1" in Pr.CL Parameter clear to initialize all parameters. (Calibration parameters are not cleared.)\*
- Set "1" in ALLC All parameter clear to initialize all parameters. \*
- Set "1" in Er.CL Alarm history clear to clear alarm history. \*
- Parameter settings can be copied to multiple inverters by using PCPY.

When parameters are copied to the 75K or more inverter from the 55K or less inverter or vice versa, an CP alarm appears on the operation panel.

For the parameters whose setting range differ, set Pr.989 as below after reset.

	55K or less	75K or more
Pr.989 setting	10	100

PCPY Setting	Description
0	Cancel
1	Copy the source parameters in the operation panel.
2	Write the parameters copied to the operation panel to the destination inverter.
3	Verify parameters in the inverter and operation panel.

\* Parameters are not cleared when "1" is set in Pr.77 Parameter write selection.

## Protective Functions

When an alarm occurs in the inverter, the protective function is activated bringing the inverter to an alarm stop and the PU display automatically changes to any of the following error (alarm) indications.

	Function Name	Description	Indication
Error message *2	Operation panel lock	Appears when operation is tried during operation panel lock.	HOLD
	Parameter write error	Appears when an error occurs at parameter writing.	Er 1 to Er 4
	Copy operation error	Appears when an error occurs at parameter copying.	rE 1 to rE 4
	Error	Appears when the RES signal is on or the PU and inverter can not make normal communication.	Err.
Warnings *3	Stall Prevention (overcurrent)	Appears during overcurrent stall prevention.	OL
	Stall prevention (overvoltage)	Appears during overvoltage stall prevention Appears while the regeneration avoidance function is activated.	oL
	Regenerative brake prealarm	Appears if the regenerative brake duty reaches or exceeds 85% of the Pr. 70 "special regenerative brake duty" value. If the regenerative brake duty reaches 100%, a regenerative overvoltage (E. OV_) occurs. (displayed only for the 75K or more)	rb
	Electronic thermal relay function prealarm	Appears when the electronic thermal O/L relay has reached 85% of the specified value.	rH
	PU Stop	Appears when  on the operation panel was pressed during external operation.	PS
	Maintenance signal output	Appears when the cumulative energization time has exceeded the maintenance output timer set value.	nr
	Parameter copy	Appears when parameters are copied between models with capacities of 55K or less and 75K or more.	CP
Minor fault *4	Fan fault	Appears when the cooling fan remains stopped when operation is required or when the speed has decreased.	Fn
Major failures *5	Overcurrent shut-off during acceleration	Appears when an overcurrent occurred during acceleration.	E0C 1
	Overcurrent shut-off during constant speed	Appears when an overcurrent occurred during constant speed operation.	E0C 2
	Overcurrent shut-off during deceleration or stop	Appears when an overcurrent occurred during deceleration and at a stop.	E0C 3
	Regenerative overvoltage shutoff during acceleration	Appears when an overvoltage occurred during acceleration.	E0U 1
	Regenerative overvoltage shut-off during constant speed	Appears when an overvoltage occurred during constant speed operation.	E0U 2
	Regenerative overvoltage shut-off during deceleration or stop	Appears when an overvoltage occurred during deceleration and at a stop.	E0U 3
	Inverter overload shut-off (electronic thermal relay function)*1	Appears when the electronic thermal relay function for inverter element protection was activated.	EfHr
	Motor overload shut-off (electronic thermal relay function)*1	Appears when the electronic thermal relay function for motor protection was activated.	EfHn
	Fin overheat	Appears when the heatsink overheated.	EfIn
	Instantaneous power failure protection	Appears when an instantaneous power failure occurred at an input power supply.	EiPF
	Undervoltage protection	Appears when the main circuit DC voltage became low.	EUuF
	Input phase failure	Appears if one of the three phases on the inverter input side opened.	EiLF
	Stall prevention	Appears when the output frequency drops to 0.5Hz as a result of deceleration due to the excess motor load.	EOLr
	Output side earth (ground) fault overcurrent protection	Appears when an earth (ground) fault occurred on the inverter's output side.	E. GF
	Output phase failure protection	Appears if one of the three phases on the inverter output side opened.	E. LF
	External thermal relay operation *6	Appears when the external thermal relay connected to the terminal OH operated.	E0Hr
	PTC thermistor operation	Appears when the motor overheat status is detected for 10s or more by the external PTC thermistor input connected to the terminal AU.	EPrC
	Option alarm	Appears when an alarm occurred in the option card or an AC power supply is connected to the R/L1, S/L2, T/L3 when the high power factor converter connection is set.	EOPr
	Option slot alarm	Appears when a communication error occurred in the communication option.	EOP 1
	Option alarm	Appears when a functional error occurred in the plug-in option.	E. 1
Parameter storage device alarm	Appears when operation of the element where parameters are stored became abnormal. (control circuit board)	E. PE	

Function Name	Description	Indication	
Major failures *5	PU disconnection	Appears when a communication error between the PU and inverter occurred, the communication interval exceeded the permissible time during the RS-485 communication with the PU connector, or communication errors exceeded the number of retries during the RS-485 communication.	EPUE
	Retry count excess	Appears when the operation was not restarted within the set number of retries.	ErEr
	Parameter storage device alarm	Appears when operation of the element where parameters stored became abnormal. (main circuit board)	EPE2
	CPU error	Appears during the CPU and peripheral circuit errors.	E 6/ E 7/ ECPU
	Operation panel power supply short circuit RS-485 terminals power supply short circuit	Appears when the RS-485 terminal power supply or operation panel power supply was shorted.	ECFE
	24VDC power output short circuit	Appears when terminals PC-SD were shorted.	EP24
	Output current detection value exceeded	Appears when output current exceeded the output current detection level set by the parameter.	ECdD
	Inrush resistor overheat	Appears when the resistor of the inrush current limit circuit overheated.	EIOH
	Communication error (inverter)	Appears when a communication error occurred during the RS-485 communication with the RS-485 terminals.	ESEr
	Analog input error	Appears when 30mA or more is input or a voltage (7.5V or more) is input with the terminal 2/4 set to current input.	EAI E
	Internal circuit error	Appears when an internal circuit error occurred.	E 13
Brake transistor alarm detection	This function stops the inverter output if an alarm occurs in the brake circuit, e.g. damaged brake transistors. In this case, the inverter must be powered off immediately. (Internal circuit error for the model 55K or less)	E. bE	

- \*1 Resetting the inverter initializes the internal thermal integrated data of the electronic thermal relay function.
- \*2 The error message shows an operational error. The inverter output is not shut off.
- \*3 Warnings are messages given before major failures occur. The inverter output is not shut off.
- \*4 Minor faults warn the operator of failures with output signals. The inverter output is not shut off.
- \*5 When major failures occur, the protective functions are activated to shut off the inverter output and output the alarms.
- \*6 The external thermal operates only when the OH signal is set in Pr. 178 to Pr. 189 (input terminal function selection).

- Features
- Peripheral Devices  
Why energy savings?
- Standard Specifications
- Outline Dimension Drawings
- Terminal Connection Diagram  
Terminal Specification Explanation
- Operation Panel
- Parameter List
- Explanations of Parameters
- Protective Functions
- Options
- Instructions
- Motor
- Compatibility
- Warranty
- Inquiry

## Option and Peripheral Devices

### Options

By fitting the following options to the inverter, the inverter is provided with more functions.  
One plug-in option can be fitted.

	Name	Type	Applications, Specifications, etc.	Applicable Inverter
Plug-in Type	16-bit digital input	FR-A7AX	<ul style="list-style-type: none"> <li>This input interface sets the high frequency accuracy of the inverter using an external BCD or binary digital signal.</li> <li>BCD code 3 digits (maximum 999)</li> <li>BCD code 4 digits (maximum 9999)</li> <li>Binary 12 bits (maximum FFFH)</li> <li>Binary 16 bits (maximum FFFFH)</li> </ul>	Shared among all models
	Digital output extension analog output	FR-A7AY	<ul style="list-style-type: none"> <li>This option provides the inverter with open collector outputs selected from among the standard output signals.</li> </ul>	
			<ul style="list-style-type: none"> <li>This option adds two different signals that can be monitored at the terminals FM and AM, such as the output frequency, output voltage and output current.</li> <li>20mADC or 5VDC (10V) meter can be connected.</li> </ul>	
	Relay output	FR-A7AR	<ul style="list-style-type: none"> <li>Output any three output signals available with the inverter as standard from the relay contact terminals</li> </ul>	
	Communication	CC-LINK	FR-A7NC	
LONWORKS		FR-A7NL		
Stand-alone Shared	Parameter unit (Eightlanguages)	FR-PU04	Interactive parameter unit with LCD display	Shared among all models
	Parameter unit connection cable	FR-CB20□	Cable for connection of operation panel or parameter unit □ indicates a cable length. (1m, 3m, 5m)	
	Operation panel connection connector	FR-ADP	Connector to connect the operation panel (FR-DU07) and connection cable	
	Intercompatibility attachment	FR-AAT	Attachment for replacing with the F700 series using the installation holes of the FR-F500.	According to capacities
		FR-A5AT	Attachment for replacing with the F700 series using the installation holes of the FR-A100<Excellent> and FR-A200<Excellent>	
	AC reactor	FR-HAL	For harmonic current reduction and inverter input power factor improvement (total power factor approx. 88%)	For 200V class 55K or less, 400V class 75K or less
	DC reactor	FR-HEL	For harmonic current reduction and inverter input power factor improvement (total power factor approx. 93%)	For the 55K or less
	Line noise filter	FR-BSF01 FR-BLF	For line noise reduction	Shared among all models
	BU type brake unit	BU	For increasing the braking capability of the inverter (for high-inertia load or negative load)	For the 55K or less
	Brake unit	FR-BU MT-BU5	For increasing the braking capability of the inverter (for high-inertia load or negative load) Brake unit and resistor unit are used in combination	According to capacities
	Resistor unit	FR-BR MT-BR5		
	Power regeneration common converter	FR-CV	Unit which can return motor-generated braking energy back to the power supply in common converter system	For the 55K or less
	Dedicated stand-alone reactor for the FR-CV	FR-CVL		
	Power regeneration converter	MT-RC	Energy saving type high performance brake unit which can regenerate the braking energy generated by the motor to the power supply.	For the 75K or more
	High power factor converter	FR-HC MT-HC	The high power factor converter switches the converter section on/off to reshape an input current waveform into a sine wave, greatly suppressing harmonics. (Used in combination with the standard accessory.)	According to capacities
	Surge voltage suppression filter	FR-ASF	Filter for suppressing surge voltage on motor	For 400V class 55K or less
Sine wave filter	Reactor	MT-BSL	Reduce the motor noise during inverter driving Use in combination with a reactor and a capacitor	For the 75K or more
	Capacitor	MT-BSC		



	Name	Type	Applications, Specifications, etc.	Applicable Inverter
FR Series Manual Controller/Speed Controller	Manual controller	FR-AX	For independent operation. With frequency meter, frequency setting potentiometer and start switch.	Shared among all models
	DC tach. follower	FR-AL	For synchronous operation (1.5VA) by external signal (0 to 5V, 0 to 10V DC) *	
	Three speed selector	FR-AT	For three speed switching, among high, middle and low speed operation (1.5VA) *	
	Motorized speed setter	FR-FK	For remote operation. Allows operation to be controlled from several places (5VA) *	
	Ratio setter	FR-FH	For ratio operation. Allows ratios to be set to five inverters. (3VA) *	
	PG follower	FR-FP	For tracking operation by a pilot generator (PG) signal (3VA) *	
	Master controller	FR-FG	Master controller (5VA) for parallel operation of multiple (maximum 35) inverters. *	
	Soft starter	FR-FC	For soft start and stop. Enables acceleration/deceleration in parallel operation (3VA) *	
	Deviation detector	FR-FD	For continuous speed control operation. Used in combination with a deviation sensor or synchro (5VA) *	
	Preamplifier	FR-FA	Used as an A/V converter or arithmetic amplifier (3VA) *	
Others	Pilot generator	QVAH-10	For tracking operation. 70V/35VAC 500Hz (at 2500r/min)	Shared among all models
	Deviation sensor	YVGC-500W-NS	For continuous speed control operation (mechanical deviation detection). Output 90VAC/90°	
	Frequency setting potentiometer	WA2W 1kΩ	For frequency setting. Wirewound 2W 1kΩ B characteristic	
	Frequency meter	YM206NRI 1mA	Dedicated frequency meter (graduated to 120Hz). Moving-coil type DC ammeter	
	Calibration resistor	RV24YN 10kΩ	For frequency meter calibration. Carbon film type B characteristic	
	Inverter setup software (FR Configurator)	FR-SW1-SETUP-WE	Supports an inverter startup to maintenance.	

\* Rated power consumption. The power supply specifications of the FR series manual controllers and speed controllers are 200VAC 50Hz, 220V/220VAC 60Hz, and 115VAC 60Hz.

- Features
- Peripheral Devices  
Why energy savings?
- Standard Specifications
- Outline Dimension Drawings
- Terminal Connection Diagram  
Terminal Specification Explanation
- Operation Panel
- Parameter List
- Explanations of Parameters
- Protective Functions
- Options
- Instructions
- Motor
- Compatibility
- Warranty
- Inquiry

● Stand-alone option

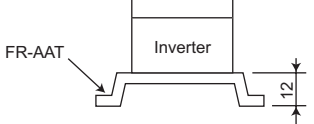
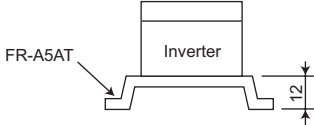
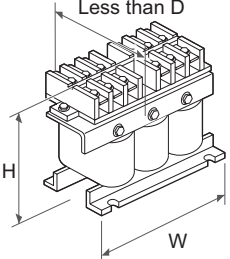
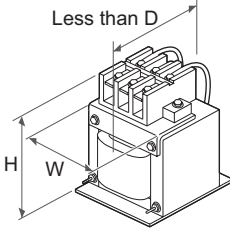
Name (type)	Specifications, Structure, etc.																																																																																																																																																																										
Intercompatibility attachment FR-AAT□□ FR-A5AT□□	<ul style="list-style-type: none"> <li>● FR-F500 series intercompatibility attachment                              The FR-F700 series inverter can be installed using installation holes of the conventional FR-F500 series with this attachment. This attachment is useful for replacing the conventional model with the FR-F700 series.                              Since the installation size of the 400V class 0.75K to 3.7K, 7.5K, 22K, 37K to 55K are the same, an intercompatibility attachment is not necessary                              * The depth increases after installation of the inverter when the attachment is used.                         </li> </ul>  <table border="1" data-bbox="810 421 1181 526"> <thead> <tr> <th>Type</th> <th>Applied Inverter</th> </tr> </thead> <tbody> <tr> <td>FR-AAT22</td> <td>FR-F740-5.5K</td> </tr> <tr> <td>FR-AAT24</td> <td>FR-F740-15K, 18.5K</td> </tr> <tr> <td>FR-AAT27</td> <td>FR-F740-30K</td> </tr> </tbody> </table> <ul style="list-style-type: none"> <li>● FR-A100E and FR-A200E series installation intercompatibility attachment                              The FR-F700 series inverter can be installed using installation holes of the conventional FR-A100E and FR-A200E series with this attachment. This attachment is useful for replacing the conventional model with the FR-F700 series.                              * The depth increases after installation of the inverter when the attachment is used.                         </li> </ul>  <table border="1" data-bbox="810 645 1181 772"> <thead> <tr> <th>Type</th> <th>Applied Inverter</th> </tr> </thead> <tbody> <tr> <td>FR-A5AT02</td> <td>FR-F740-0.75K to 3.7K</td> </tr> <tr> <td>FR-A5AT03</td> <td>FR-F740-5.5K to 11K</td> </tr> <tr> <td>FR-A5AT04</td> <td>FR-F740-15K to 22K</td> </tr> <tr> <td>FR-A5AT05</td> <td>FR-F740-45K, 55K</td> </tr> </tbody> </table>	Type	Applied Inverter	FR-AAT22	FR-F740-5.5K	FR-AAT24	FR-F740-15K, 18.5K	FR-AAT27	FR-F740-30K	Type	Applied Inverter	FR-A5AT02	FR-F740-0.75K to 3.7K	FR-A5AT03	FR-F740-5.5K to 11K	FR-A5AT04	FR-F740-15K to 22K	FR-A5AT05	FR-F740-45K, 55K																																																																																																																																																								
Type	Applied Inverter																																																																																																																																																																										
FR-AAT22	FR-F740-5.5K																																																																																																																																																																										
FR-AAT24	FR-F740-15K, 18.5K																																																																																																																																																																										
FR-AAT27	FR-F740-30K																																																																																																																																																																										
Type	Applied Inverter																																																																																																																																																																										
FR-A5AT02	FR-F740-0.75K to 3.7K																																																																																																																																																																										
FR-A5AT03	FR-F740-5.5K to 11K																																																																																																																																																																										
FR-A5AT04	FR-F740-15K to 22K																																																																																																																																																																										
FR-A5AT05	FR-F740-45K, 55K																																																																																																																																																																										
AC reactor (for power coordination) FR-HAL-(H)□□K	<ul style="list-style-type: none"> <li>● Outline dimension (Unit: mm)</li> </ul> <table border="1" data-bbox="391 840 1101 1288"> <thead> <tr> <th>Type</th> <th>W</th> <th>D</th> <th>H</th> <th>Mass (kg)</th> <th>Type</th> <th>W</th> <th>D</th> <th>H</th> <th>Mass (kg)</th> </tr> </thead> <tbody> <tr><td>0.4K</td><td>104</td><td>72</td><td>99</td><td>0.6</td><td>H0.4K</td><td>135</td><td>59.6</td><td>115</td><td>1.5</td></tr> <tr><td>0.75K</td><td>104</td><td>74</td><td>99</td><td>0.8</td><td>H0.75K</td><td>135</td><td>59.6</td><td>115</td><td>1.5</td></tr> <tr><td>1.5K</td><td>104</td><td>77</td><td>99</td><td>1.1</td><td>H1.5K</td><td>135</td><td>59.6</td><td>115</td><td>1.5</td></tr> <tr><td>2.2K</td><td>115</td><td>77</td><td>115</td><td>1.5</td><td>H2.2K</td><td>135</td><td>59.6</td><td>115</td><td>1.5</td></tr> <tr><td>3.7K</td><td>115</td><td>83</td><td>115</td><td>2.2</td><td>H3.7K</td><td>135</td><td>70.6</td><td>115</td><td>2.5</td></tr> <tr><td>5.5K</td><td>115</td><td>83</td><td>115</td><td>2.3</td><td>H5.5K</td><td>160</td><td>72</td><td>142</td><td>3.5</td></tr> <tr><td>7.5K</td><td>130</td><td>100</td><td>135</td><td>4.2</td><td>H7.5K</td><td>160</td><td>91</td><td>142</td><td>5.0</td></tr> <tr><td>11K</td><td>160</td><td>111</td><td>164</td><td>5.2</td><td>H11K</td><td>160</td><td>91</td><td>146</td><td>6.0</td></tr> <tr><td>15K</td><td>160</td><td>126</td><td>167</td><td>7.0</td><td>H15K</td><td>220</td><td>105</td><td>195</td><td>9.0</td></tr> <tr><td>18.5K</td><td>160</td><td>175</td><td>128</td><td>7.1</td><td>H18.5K</td><td>220</td><td>170</td><td>215</td><td>9.0</td></tr> <tr><td>22K</td><td>185</td><td>158</td><td>150</td><td>9.0</td><td>H22K</td><td>220</td><td>170</td><td>215</td><td>9.5</td></tr> <tr><td>30K</td><td>185</td><td>168</td><td>150</td><td>9.7</td><td>H30K</td><td>220</td><td>170</td><td>215</td><td>11</td></tr> <tr><td>37K</td><td>210</td><td>174</td><td>175</td><td>12.9</td><td>H37K</td><td>220</td><td>170</td><td>214</td><td>12.5</td></tr> <tr><td>45K</td><td>210</td><td>191</td><td>175</td><td>16.4</td><td>H45K</td><td>280</td><td>165</td><td>245</td><td>15</td></tr> <tr><td>55K</td><td>210</td><td>201</td><td>175</td><td>17.4</td><td>H55K</td><td>280</td><td>170</td><td>245</td><td>18</td></tr> <tr><td></td><td></td><td></td><td></td><td></td><td>H75K</td><td>205</td><td>208</td><td>170</td><td>20</td></tr> </tbody> </table>  <p>(Note) 1. Make selection according to the applied motor capacity. (When the inverter capacity is larger than the motor capacity, make selection according to the motor capacity)                  2. Power factor improving reactor (FR-BAL) can be used.                  Power factor improving effect                  FR-BAL : approx. 90%                  FR-HAL : approx. 88%</p>	Type	W	D	H	Mass (kg)	Type	W	D	H	Mass (kg)	0.4K	104	72	99	0.6	H0.4K	135	59.6	115	1.5	0.75K	104	74	99	0.8	H0.75K	135	59.6	115	1.5	1.5K	104	77	99	1.1	H1.5K	135	59.6	115	1.5	2.2K	115	77	115	1.5	H2.2K	135	59.6	115	1.5	3.7K	115	83	115	2.2	H3.7K	135	70.6	115	2.5	5.5K	115	83	115	2.3	H5.5K	160	72	142	3.5	7.5K	130	100	135	4.2	H7.5K	160	91	142	5.0	11K	160	111	164	5.2	H11K	160	91	146	6.0	15K	160	126	167	7.0	H15K	220	105	195	9.0	18.5K	160	175	128	7.1	H18.5K	220	170	215	9.0	22K	185	158	150	9.0	H22K	220	170	215	9.5	30K	185	168	150	9.7	H30K	220	170	215	11	37K	210	174	175	12.9	H37K	220	170	214	12.5	45K	210	191	175	16.4	H45K	280	165	245	15	55K	210	201	175	17.4	H55K	280	170	245	18						H75K	205	208	170	20
Type	W	D	H	Mass (kg)	Type	W	D	H	Mass (kg)																																																																																																																																																																		
0.4K	104	72	99	0.6	H0.4K	135	59.6	115	1.5																																																																																																																																																																		
0.75K	104	74	99	0.8	H0.75K	135	59.6	115	1.5																																																																																																																																																																		
1.5K	104	77	99	1.1	H1.5K	135	59.6	115	1.5																																																																																																																																																																		
2.2K	115	77	115	1.5	H2.2K	135	59.6	115	1.5																																																																																																																																																																		
3.7K	115	83	115	2.2	H3.7K	135	70.6	115	2.5																																																																																																																																																																		
5.5K	115	83	115	2.3	H5.5K	160	72	142	3.5																																																																																																																																																																		
7.5K	130	100	135	4.2	H7.5K	160	91	142	5.0																																																																																																																																																																		
11K	160	111	164	5.2	H11K	160	91	146	6.0																																																																																																																																																																		
15K	160	126	167	7.0	H15K	220	105	195	9.0																																																																																																																																																																		
18.5K	160	175	128	7.1	H18.5K	220	170	215	9.0																																																																																																																																																																		
22K	185	158	150	9.0	H22K	220	170	215	9.5																																																																																																																																																																		
30K	185	168	150	9.7	H30K	220	170	215	11																																																																																																																																																																		
37K	210	174	175	12.9	H37K	220	170	214	12.5																																																																																																																																																																		
45K	210	191	175	16.4	H45K	280	165	245	15																																																																																																																																																																		
55K	210	201	175	17.4	H55K	280	170	245	18																																																																																																																																																																		
					H75K	205	208	170	20																																																																																																																																																																		
DC reactor (for power coordination) FR-HEL-(H)□□K	<ul style="list-style-type: none"> <li>● Outline dimension (Unit: mm)</li> </ul> <table border="1" data-bbox="391 1377 1101 1803"> <thead> <tr> <th>Type</th> <th>W</th> <th>D</th> <th>H</th> <th>Mass (kg)</th> <th>Type</th> <th>W</th> <th>D</th> <th>H</th> <th>Mass (kg)</th> </tr> </thead> <tbody> <tr><td>0.4K</td><td>70</td><td>61</td><td>71</td><td>0.4</td><td>H0.4K</td><td>90</td><td>60</td><td>78</td><td>0.6</td></tr> <tr><td>0.75K</td><td>85</td><td>61</td><td>81</td><td>0.5</td><td>H0.75K</td><td>66</td><td>70</td><td>100</td><td>0.8</td></tr> <tr><td>1.5K</td><td>85</td><td>70</td><td>81</td><td>0.8</td><td>H1.5K</td><td>66</td><td>80</td><td>100</td><td>1</td></tr> <tr><td>2.2K</td><td>85</td><td>70</td><td>81</td><td>0.9</td><td>H2.2K</td><td>76</td><td>80</td><td>110</td><td>1.3</td></tr> <tr><td>3.7K</td><td>77</td><td>82</td><td>92</td><td>1.5</td><td>H3.7K</td><td>86</td><td>95</td><td>120</td><td>2.3</td></tr> <tr><td>5.5K</td><td>77</td><td>92</td><td>92</td><td>1.9</td><td>H5.5K</td><td>96</td><td>100</td><td>128</td><td>3</td></tr> <tr><td>7.5K</td><td>86</td><td>98</td><td>113</td><td>2.5</td><td>H7.5K</td><td>96</td><td>105</td><td>128</td><td>3.5</td></tr> <tr><td>11K</td><td>105</td><td>112</td><td>133</td><td>3.3</td><td>H11K</td><td>105</td><td>110</td><td>137</td><td>4.5</td></tr> <tr><td>15K</td><td>105</td><td>115</td><td>133</td><td>4.1</td><td>H15K</td><td>105</td><td>125</td><td>152</td><td>5</td></tr> <tr><td>18.5K</td><td>105</td><td>165</td><td>93</td><td>4.7</td><td>H18.5K</td><td>114</td><td>120</td><td>162</td><td>5</td></tr> <tr><td>22K</td><td>105</td><td>175</td><td>93</td><td>5.6</td><td>H22K</td><td>133</td><td>120</td><td>178</td><td>6</td></tr> <tr><td>30K</td><td>114</td><td>200</td><td>100</td><td>7.8</td><td>H30K</td><td>133</td><td>120</td><td>178</td><td>6.5</td></tr> <tr><td>37K</td><td>133</td><td>195</td><td>117</td><td>10</td><td>H37K</td><td>133</td><td>155</td><td>187</td><td>8.5</td></tr> <tr><td>45K</td><td>133</td><td>205</td><td>117</td><td>11</td><td>H45K</td><td>133</td><td>170</td><td>187</td><td>10</td></tr> <tr><td>55K</td><td>153</td><td>209</td><td>132</td><td>12.6</td><td>H55K</td><td>152</td><td>170</td><td>206</td><td>11.5</td></tr> </tbody> </table>  <p>(Note) 1. Be sure to remove the jumper across terminals P/+ - P1 of the inverter. (A failure to do so will produce no power factor improving effect)                  2. The wiring length between the reactor and inverter should be within 5m.                  3. The size of the cables used should be equal to or larger than that of the power supply cables (R/L1, S/L2, T/L3).                  4. Make selection according to the motor capacity.                  (When the inverter capacity is larger than the motor capacity, make selection according to the motor capacity)                  5. Power factor improving reactor (FR-BEL) can be used.                  Power factor improving effect                  FR-BEL : approx. 95%                  FR-HEL : approx. 93%</p>	Type	W	D	H	Mass (kg)	Type	W	D	H	Mass (kg)	0.4K	70	61	71	0.4	H0.4K	90	60	78	0.6	0.75K	85	61	81	0.5	H0.75K	66	70	100	0.8	1.5K	85	70	81	0.8	H1.5K	66	80	100	1	2.2K	85	70	81	0.9	H2.2K	76	80	110	1.3	3.7K	77	82	92	1.5	H3.7K	86	95	120	2.3	5.5K	77	92	92	1.9	H5.5K	96	100	128	3	7.5K	86	98	113	2.5	H7.5K	96	105	128	3.5	11K	105	112	133	3.3	H11K	105	110	137	4.5	15K	105	115	133	4.1	H15K	105	125	152	5	18.5K	105	165	93	4.7	H18.5K	114	120	162	5	22K	105	175	93	5.6	H22K	133	120	178	6	30K	114	200	100	7.8	H30K	133	120	178	6.5	37K	133	195	117	10	H37K	133	155	187	8.5	45K	133	205	117	11	H45K	133	170	187	10	55K	153	209	132	12.6	H55K	152	170	206	11.5										
Type	W	D	H	Mass (kg)	Type	W	D	H	Mass (kg)																																																																																																																																																																		
0.4K	70	61	71	0.4	H0.4K	90	60	78	0.6																																																																																																																																																																		
0.75K	85	61	81	0.5	H0.75K	66	70	100	0.8																																																																																																																																																																		
1.5K	85	70	81	0.8	H1.5K	66	80	100	1																																																																																																																																																																		
2.2K	85	70	81	0.9	H2.2K	76	80	110	1.3																																																																																																																																																																		
3.7K	77	82	92	1.5	H3.7K	86	95	120	2.3																																																																																																																																																																		
5.5K	77	92	92	1.9	H5.5K	96	100	128	3																																																																																																																																																																		
7.5K	86	98	113	2.5	H7.5K	96	105	128	3.5																																																																																																																																																																		
11K	105	112	133	3.3	H11K	105	110	137	4.5																																																																																																																																																																		
15K	105	115	133	4.1	H15K	105	125	152	5																																																																																																																																																																		
18.5K	105	165	93	4.7	H18.5K	114	120	162	5																																																																																																																																																																		
22K	105	175	93	5.6	H22K	133	120	178	6																																																																																																																																																																		
30K	114	200	100	7.8	H30K	133	120	178	6.5																																																																																																																																																																		
37K	133	195	117	10	H37K	133	155	187	8.5																																																																																																																																																																		
45K	133	205	117	11	H45K	133	170	187	10																																																																																																																																																																		
55K	153	209	132	12.6	H55K	152	170	206	11.5																																																																																																																																																																		

Name (type)	Specifications, Structure, etc.																																																																																																																																																																				
<p>Line noise filter FR-BSF01...for small capacities FR-BLF</p>	<p>● Outline dimension</p> <div style="display: flex; justify-content: space-around;"> <div style="text-align: center;"> <p>FR-BSF01</p> </div> <div style="text-align: center;"> <p>FR-BLF</p> </div> <div style="text-align: center;"> </div> </div> <p>(Note) 1. Each phase should be wound at least 3 times (4T, 4 turns) in the same direction. (The greater the number of turns, the more efficient.)                  2. When the thickness of the wire prevents winding, use at least 4 in series and ensure that the current passes through each phase in the same direction.                  3. Can be used on the output side in the same way as the input side.                  4. Please use FR-BSF01 for inverters with small capacities of 3.7K or less. Thick wires (38mm<sup>2</sup> or more) can not be used. In such cases, use the FR-BLF.</p>																																																																																																																																																																				
<p>Brake unit BU-(H)□□ Electrical-discharge resistor GZG type GRZG type</p>	<p>● A brake unit is an option that fully enhances the regenerative braking capability of the inverter, and should be used with an electrical-discharge resistor.                  ● Brake units should be selected according to the required braking torque.                  ● Brake unit selection table</p> <table border="1" style="width: 100%; text-align: center;"> <thead> <tr> <th rowspan="2">Voltage</th> <th rowspan="2">Braking torque</th> <th colspan="13">Motor(kW)</th> </tr> <tr> <th>0.75</th><th>1.5</th><th>2.2</th><th>3.7</th><th>5.5</th><th>7.5</th><th>11</th><th>15</th><th>18.5</th><th>22</th><th>30</th><th>37</th><th>45</th><th>55</th> </tr> </thead> <tbody> <tr> <td rowspan="2">200V output</td> <td>50%30s</td> <td colspan="2">BU-1500</td> <td colspan="2">BU-3700</td> <td colspan="2">BU-7.5K</td> <td colspan="2">BU-15K</td> <td colspan="2">2×BU-15K</td> <td colspan="2">3×BU-15K</td> <td colspan="2">4×BU-15K</td> </tr> <tr> <td>100%30s</td> <td>BU-1500</td><td>BU-3700</td><td colspan="2">BU-7.5K</td><td colspan="2">BU-15K</td><td colspan="2">2×BU-15K</td><td colspan="2">3×BU-15K</td><td>4×BU-15K</td><td>5×BU-15K</td><td>6×BU-15K</td><td>7×BU-15K</td> </tr> <tr> <td rowspan="2">400V output</td> <td>50%30s</td> <td colspan="13">BU-H7.5K</td> <td colspan="2">BU-H15K</td> <td colspan="2">BU-H30K</td> <td colspan="2">2×BU-H30K</td> </tr> <tr> <td>100%30s</td> <td colspan="2">*</td><td colspan="2">BU-H7.5K</td><td colspan="2">BU-H15K</td><td colspan="2">BU-H30K</td><td colspan="2">2×BU-H30K</td><td colspan="2">3×BU-H30K</td><td colspan="2">4×BU-H30K</td> </tr> </tbody> </table> <p>* The inverter of 1.5K or less with 400V output can not be used in combination with a brake unit. To use in combination with a brake unit, use the inverter of 2.2K or more.</p> <p>● Combination of brake unit and electrical discharge resistor</p> <table border="1" style="width: 100%; text-align: center;"> <thead> <tr> <th rowspan="2">Voltage</th> <th rowspan="2">Brake unit</th> <th rowspan="2">Resistor type</th> <th rowspan="2">Cable (P, N)</th> <th rowspan="2">Voltage</th> <th rowspan="2">Brake unit</th> <th rowspan="2">Resistor type</th> <th rowspan="2">Cable (P, N)</th> </tr> <tr> <th>200V output</th> <th>400V output</th> </tr> </thead> <tbody> <tr> <td rowspan="4">200V output</td> <td>BU-1500</td> <td>GZG300W-50Ω(one)</td> <td>2mm<sup>2</sup></td> <td rowspan="4">400V output</td> <td>BU-H7.5K</td> <td>GRZG200-10Ω (six in series)</td> <td>2mm<sup>2</sup></td> </tr> <tr> <td>BU-3700</td> <td>GRZG200-10Ω (three in series)</td> <td>2mm<sup>2</sup></td> <td>BU-H15K</td> <td>GRZG300-5Ω (eight in series)</td> <td>3.5mm<sup>2</sup></td> </tr> <tr> <td>BU-7.5K</td> <td>GRZG300-5Ω (four in series)</td> <td>3.5mm<sup>2</sup></td> <td>BU-H30K</td> <td>GRZG400-2Ω (twelve in series)</td> <td>3.5mm<sup>2</sup></td> </tr> <tr> <td>BU-15K</td> <td>GRZG400-2Ω (six in series)</td> <td>3.5mm<sup>2</sup></td> <td></td> <td></td> <td></td> </tr> </tbody> </table> <p>● Brake unit</p> <table border="1" style="width: 100%; text-align: center;"> <thead> <tr> <th>Type</th> <th>W</th> <th>D</th> <th>H</th> </tr> </thead> <tbody> <tr> <td>BU-1500, 3700, 7.5K, 15K</td> <td>100</td> <td>128</td> <td>240</td> </tr> <tr> <td>BU-H7.5K, H15K, H30K</td> <td>160</td> <td>145</td> <td>240</td> </tr> </tbody> </table> <p>(Unit: mm)</p> <p>● Discharge resistor</p> <table border="1" style="width: 100%; text-align: center;"> <thead> <tr> <th>Type</th> <th>W</th> <th>D</th> <th>H</th> </tr> </thead> <tbody> <tr> <td>GZG300W</td> <td>335</td> <td>40</td> <td>78</td> </tr> <tr> <td>GRZG200</td> <td>306</td> <td>26</td> <td>55</td> </tr> <tr> <td>GRZG300</td> <td>334</td> <td>40</td> <td>79</td> </tr> <tr> <td>GRZG400</td> <td>411</td> <td>40</td> <td>79</td> </tr> </tbody> </table> <p>(Unit: mm)</p> <p>(Note) 1. Connect so that the terminal symbols are the same for both inverter and brake unit. Incorrect connection will damage the inverter.                  2. Minimize the cable length between the inverter and brake unit and between the discharging resistor and brake unit. Use a twisted cable when the wiring length exceeds 2m. (If twisted cables are used, the wiring length should be within 5m.)</p> <p>● Handling precautions</p> <ol style="list-style-type: none"> <li>The thermal relay in the brake unit will trip if the rated torque is continuously output. After a trip, reset the inverter and increase its deceleration time setting.</li> <li>The maximum temperature rise of the discharging resistor is 100 °C. Use heat-resistant wires and wire to avoid contact with resistors.</li> </ol>	Voltage	Braking torque	Motor(kW)													0.75	1.5	2.2	3.7	5.5	7.5	11	15	18.5	22	30	37	45	55	200V output	50%30s	BU-1500		BU-3700		BU-7.5K		BU-15K		2×BU-15K		3×BU-15K		4×BU-15K		100%30s	BU-1500	BU-3700	BU-7.5K		BU-15K		2×BU-15K		3×BU-15K		4×BU-15K	5×BU-15K	6×BU-15K	7×BU-15K	400V output	50%30s	BU-H7.5K													BU-H15K		BU-H30K		2×BU-H30K		100%30s	*		BU-H7.5K		BU-H15K		BU-H30K		2×BU-H30K		3×BU-H30K		4×BU-H30K		Voltage	Brake unit	Resistor type	Cable (P, N)	Voltage	Brake unit	Resistor type	Cable (P, N)	200V output	400V output	200V output	BU-1500	GZG300W-50Ω(one)	2mm <sup>2</sup>	400V output	BU-H7.5K	GRZG200-10Ω (six in series)	2mm <sup>2</sup>	BU-3700	GRZG200-10Ω (three in series)	2mm <sup>2</sup>	BU-H15K	GRZG300-5Ω (eight in series)	3.5mm <sup>2</sup>	BU-7.5K	GRZG300-5Ω (four in series)	3.5mm <sup>2</sup>	BU-H30K	GRZG400-2Ω (twelve in series)	3.5mm <sup>2</sup>	BU-15K	GRZG400-2Ω (six in series)	3.5mm <sup>2</sup>				Type	W	D	H	BU-1500, 3700, 7.5K, 15K	100	128	240	BU-H7.5K, H15K, H30K	160	145	240	Type	W	D	H	GZG300W	335	40	78	GRZG200	306	26	55	GRZG300	334	40	79	GRZG400	411	40	79
Voltage	Braking torque			Motor(kW)																																																																																																																																																																	
		0.75	1.5	2.2	3.7	5.5	7.5	11	15	18.5	22	30	37	45	55																																																																																																																																																						
200V output	50%30s	BU-1500		BU-3700		BU-7.5K		BU-15K		2×BU-15K		3×BU-15K		4×BU-15K																																																																																																																																																							
	100%30s	BU-1500	BU-3700	BU-7.5K		BU-15K		2×BU-15K		3×BU-15K		4×BU-15K	5×BU-15K	6×BU-15K	7×BU-15K																																																																																																																																																						
400V output	50%30s	BU-H7.5K													BU-H15K		BU-H30K		2×BU-H30K																																																																																																																																																		
	100%30s	*		BU-H7.5K		BU-H15K		BU-H30K		2×BU-H30K		3×BU-H30K		4×BU-H30K																																																																																																																																																							
Voltage	Brake unit	Resistor type	Cable (P, N)	Voltage	Brake unit	Resistor type	Cable (P, N)																																																																																																																																																														
								200V output	400V output																																																																																																																																																												
200V output	BU-1500	GZG300W-50Ω(one)	2mm <sup>2</sup>	400V output	BU-H7.5K	GRZG200-10Ω (six in series)	2mm <sup>2</sup>																																																																																																																																																														
	BU-3700	GRZG200-10Ω (three in series)	2mm <sup>2</sup>		BU-H15K	GRZG300-5Ω (eight in series)	3.5mm <sup>2</sup>																																																																																																																																																														
	BU-7.5K	GRZG300-5Ω (four in series)	3.5mm <sup>2</sup>		BU-H30K	GRZG400-2Ω (twelve in series)	3.5mm <sup>2</sup>																																																																																																																																																														
	BU-15K	GRZG400-2Ω (six in series)	3.5mm <sup>2</sup>																																																																																																																																																																		
Type	W	D	H																																																																																																																																																																		
BU-1500, 3700, 7.5K, 15K	100	128	240																																																																																																																																																																		
BU-H7.5K, H15K, H30K	160	145	240																																																																																																																																																																		
Type	W	D	H																																																																																																																																																																		
GZG300W	335	40	78																																																																																																																																																																		
GRZG200	306	26	55																																																																																																																																																																		
GRZG300	334	40	79																																																																																																																																																																		
GRZG400	411	40	79																																																																																																																																																																		

- Features
- Peripheral Devices  
Why energy savings?
- Standard Specifications
- Outline Dimension Drawings
- Terminal Connection Diagram  
Terminal Specification Explanation
- Operation Panel
- Parameter List
- Explanations of Parameters
- Protective Functions
- Options
- Instructions
- Motor
- Compatibility
- Warranty
- Inquiry

Name (type)	Specifications, Structure, etc.																																																																																																				
Brake unit FR-BU-(H)□□K Resistor unit FR-BR-(H)□□K	<ul style="list-style-type: none"> <li>The brake unit and resistor unit are options that will fully exhibit the regenerative braking capability of the inverter and are always used as a set.</li> <li>There are six different brake units as in the following table, from which make selection according to the necessary braking torque and deceleration time.</li> <li>The brake unit is equipped with a seven-segment LED that displays the duty (%ED) and alarm.</li> <li><b>Brake unit selection table</b> <ul style="list-style-type: none"> <li>%ED at short-time rating when braking torque is 100%</li> </ul> </li> </ul>																																																																																																				
	<table border="1" style="width: 100%; border-collapse: collapse; text-align: center;"> <thead> <tr> <th colspan="2">Motor Capacity</th> <th>5.5kW</th> <th>7.5kW</th> <th>11kW</th> <th>15kW</th> <th>18.5kW</th> <th>22kW</th> <th>30kW</th> <th>37kW</th> <th>45kW</th> <th>55kW</th> </tr> </thead> <tbody> <tr> <td rowspan="2">Inverter</td> <td>200V</td> <td>5.5K</td> <td>7.5K</td> <td>11K</td> <td>15K</td> <td>18.5K</td> <td>22K</td> <td>30K</td> <td>37K</td> <td>45K</td> <td>55K</td> </tr> <tr> <td>400V</td> <td>5.5K</td> <td>7.5K</td> <td>11K</td> <td>15K</td> <td>18.5K</td> <td>22K</td> <td>30K</td> <td>37K</td> <td>45K</td> <td>55K</td> </tr> <tr> <td rowspan="6">Brake unit</td> <td rowspan="3">200V</td> <td>FR-BU-15K</td> <td>80</td> <td>40</td> <td>15</td> <td>10</td> <td>—</td> <td>—</td> <td>—</td> <td>—</td> <td>—</td> </tr> <tr> <td>FR-BU-30K</td> <td>—</td> <td>—</td> <td>65</td> <td>30</td> <td>25</td> <td>15</td> <td>10</td> <td>—</td> <td>—</td> </tr> <tr> <td>FR-BU-55K</td> <td>—</td> <td>—</td> <td>—</td> <td>—</td> <td>90</td> <td>60</td> <td>30</td> <td>20</td> <td>15</td> <td>10</td> </tr> <tr> <td rowspan="3">400V</td> <td>FR-BU-H15K</td> <td>80</td> <td>40</td> <td>15</td> <td>10</td> <td>—</td> <td>—</td> <td>—</td> <td>—</td> <td>—</td> </tr> <tr> <td>FR-BU-H30K</td> <td>—</td> <td>—</td> <td>65</td> <td>30</td> <td>25</td> <td>15</td> <td>10</td> <td>—</td> <td>—</td> </tr> <tr> <td>FR-BU-H55K</td> <td>—</td> <td>—</td> <td>—</td> <td>—</td> <td>90</td> <td>60</td> <td>30</td> <td>20</td> <td>15</td> <td>10</td> </tr> </tbody> </table>	Motor Capacity		5.5kW	7.5kW	11kW	15kW	18.5kW	22kW	30kW	37kW	45kW	55kW	Inverter	200V	5.5K	7.5K	11K	15K	18.5K	22K	30K	37K	45K	55K	400V	5.5K	7.5K	11K	15K	18.5K	22K	30K	37K	45K	55K	Brake unit	200V	FR-BU-15K	80	40	15	10	—	—	—	—	—	FR-BU-30K	—	—	65	30	25	15	10	—	—	FR-BU-55K	—	—	—	—	90	60	30	20	15	10	400V	FR-BU-H15K	80	40	15	10	—	—	—	—	—	FR-BU-H30K	—	—	65	30	25	15	10	—	—	FR-BU-H55K	—	—	—	—	90	60	30	20	15	10
	Motor Capacity		5.5kW	7.5kW	11kW	15kW	18.5kW	22kW	30kW	37kW	45kW	55kW																																																																																									
	Inverter	200V	5.5K	7.5K	11K	15K	18.5K	22K	30K	37K	45K	55K																																																																																									
		400V	5.5K	7.5K	11K	15K	18.5K	22K	30K	37K	45K	55K																																																																																									
	Brake unit	200V	FR-BU-15K	80	40	15	10	—	—	—	—	—																																																																																									
			FR-BU-30K	—	—	65	30	25	15	10	—	—																																																																																									
			FR-BU-55K	—	—	—	—	90	60	30	20	15	10																																																																																								
		400V	FR-BU-H15K	80	40	15	10	—	—	—	—	—																																																																																									
			FR-BU-H30K	—	—	65	30	25	15	10	—	—																																																																																									
FR-BU-H55K			—	—	—	—	90	60	30	20	15	10																																																																																									
<ul style="list-style-type: none"> <li>Braking torque (%) at short-time rating when 10%ED is 15s</li> </ul>																																																																																																					
<table border="1" style="width: 100%; border-collapse: collapse; text-align: center;"> <thead> <tr> <th colspan="2">Motor Capacity</th> <th>5.5kW</th> <th>7.5kW</th> <th>11kW</th> <th>15kW</th> <th>18.5kW</th> <th>22kW</th> <th>30kW</th> <th>37kW</th> <th>45kW</th> <th>55kW</th> </tr> </thead> <tbody> <tr> <td rowspan="2">Inverter</td> <td>200V</td> <td>5.5K</td> <td>7.5K</td> <td>11K</td> <td>15K</td> <td>18.5K</td> <td>22K</td> <td>30K</td> <td>37K</td> <td>45K</td> <td>55K</td> </tr> <tr> <td>400V</td> <td>5.5K</td> <td>7.5K</td> <td>11K</td> <td>15K</td> <td>18.5K</td> <td>22K</td> <td>30K</td> <td>37K</td> <td>45K</td> <td>55K</td> </tr> <tr> <td rowspan="6">Brake unit</td> <td rowspan="3">200V</td> <td>FR-BU-15K</td> <td>280</td> <td>200</td> <td>120</td> <td>100</td> <td>80</td> <td>70</td> <td>—</td> <td>—</td> <td>—</td> </tr> <tr> <td>FR-BU-30K</td> <td>—</td> <td>—</td> <td>260</td> <td>180</td> <td>160</td> <td>130</td> <td>100</td> <td>80</td> <td>70</td> </tr> <tr> <td>FR-BU-55K</td> <td>—</td> <td>—</td> <td>—</td> <td>—</td> <td>300</td> <td>250</td> <td>180</td> <td>150</td> <td>120</td> <td>100</td> </tr> <tr> <td rowspan="3">400V</td> <td>FR-BU-H15K</td> <td>280</td> <td>200</td> <td>120</td> <td>100</td> <td>80</td> <td>70</td> <td>—</td> <td>—</td> <td>—</td> </tr> <tr> <td>FR-BU-H30K</td> <td>—</td> <td>—</td> <td>260</td> <td>180</td> <td>160</td> <td>130</td> <td>100</td> <td>80</td> <td>70</td> </tr> <tr> <td>FR-BU-H55K</td> <td>—</td> <td>—</td> <td>—</td> <td>—</td> <td>300</td> <td>250</td> <td>180</td> <td>150</td> <td>120</td> <td>100</td> </tr> </tbody> </table>	Motor Capacity		5.5kW	7.5kW	11kW	15kW	18.5kW	22kW	30kW	37kW	45kW	55kW	Inverter	200V	5.5K	7.5K	11K	15K	18.5K	22K	30K	37K	45K	55K	400V	5.5K	7.5K	11K	15K	18.5K	22K	30K	37K	45K	55K	Brake unit	200V	FR-BU-15K	280	200	120	100	80	70	—	—	—	FR-BU-30K	—	—	260	180	160	130	100	80	70	FR-BU-55K	—	—	—	—	300	250	180	150	120	100	400V	FR-BU-H15K	280	200	120	100	80	70	—	—	—	FR-BU-H30K	—	—	260	180	160	130	100	80	70	FR-BU-H55K	—	—	—	—	300	250	180	150	120	100	
Motor Capacity		5.5kW	7.5kW	11kW	15kW	18.5kW	22kW	30kW	37kW	45kW	55kW																																																																																										
Inverter	200V	5.5K	7.5K	11K	15K	18.5K	22K	30K	37K	45K	55K																																																																																										
	400V	5.5K	7.5K	11K	15K	18.5K	22K	30K	37K	45K	55K																																																																																										
Brake unit	200V	FR-BU-15K	280	200	120	100	80	70	—	—	—																																																																																										
		FR-BU-30K	—	—	260	180	160	130	100	80	70																																																																																										
		FR-BU-55K	—	—	—	—	300	250	180	150	120	100																																																																																									
	400V	FR-BU-H15K	280	200	120	100	80	70	—	—	—																																																																																										
		FR-BU-H30K	—	—	260	180	160	130	100	80	70																																																																																										
		FR-BU-H55K	—	—	—	—	300	250	180	150	120	100																																																																																									
<ul style="list-style-type: none"> <li>Brake unit and resistor unit combinations and used cables</li> </ul>																																																																																																					
<table border="1" style="width: 100%; border-collapse: collapse; text-align: center;"> <thead> <tr> <th>Brake Unit Type</th> <th>Resistor Unit Type</th> <th>Cable (P/+ - P/+, N/- N/-, P/+ - P, PR-PR)</th> </tr> </thead> <tbody> <tr> <td rowspan="3">200V</td> <td>FR-BU-15K</td> <td>FR-BR-15K</td> <td>3.5mm<sup>2</sup></td> </tr> <tr> <td>FR-BU-30K</td> <td>FR-BR-30K</td> <td>5.5mm<sup>2</sup></td> </tr> <tr> <td>FR-BU-55K</td> <td>FR-BR-55K</td> <td>14mm<sup>2</sup></td> </tr> <tr> <td rowspan="3">400V</td> <td>FR-BU-H15K</td> <td>FR-BR-H15K</td> <td>3.5mm<sup>2</sup></td> </tr> <tr> <td>FR-BU-H30K</td> <td>FR-BR-H30K</td> <td>3.5mm<sup>2</sup></td> </tr> <tr> <td>FR-BU-H55K</td> <td>FR-BR-H55K</td> <td>5.5mm<sup>2</sup></td> </tr> </tbody> </table> <p style="font-size: small;">(Note) 1. The temperature rise of the resistor unit is about a maximum of 100°C. Therefore, use heat-resistant wires (such as glass wires).</p>	Brake Unit Type	Resistor Unit Type	Cable (P/+ - P/+, N/- N/-, P/+ - P, PR-PR)	200V	FR-BU-15K	FR-BR-15K	3.5mm <sup>2</sup>	FR-BU-30K	FR-BR-30K	5.5mm <sup>2</sup>	FR-BU-55K	FR-BR-55K	14mm <sup>2</sup>	400V	FR-BU-H15K	FR-BR-H15K	3.5mm <sup>2</sup>	FR-BU-H30K	FR-BR-H30K	3.5mm <sup>2</sup>	FR-BU-H55K	FR-BR-H55K	5.5mm <sup>2</sup>																																																																														
Brake Unit Type	Resistor Unit Type	Cable (P/+ - P/+, N/- N/-, P/+ - P, PR-PR)																																																																																																			
200V	FR-BU-15K	FR-BR-15K	3.5mm <sup>2</sup>																																																																																																		
	FR-BU-30K	FR-BR-30K	5.5mm <sup>2</sup>																																																																																																		
	FR-BU-55K	FR-BR-55K	14mm <sup>2</sup>																																																																																																		
400V	FR-BU-H15K	FR-BR-H15K	3.5mm <sup>2</sup>																																																																																																		
	FR-BU-H30K	FR-BR-H30K	3.5mm <sup>2</sup>																																																																																																		
	FR-BU-H55K	FR-BR-H55K	5.5mm <sup>2</sup>																																																																																																		
<ul style="list-style-type: none"> <li>Connection example</li> </ul>																																																																																																					
<p>*1. Connect the inverter terminals (P/+, N/-) and brake unit (FR-BU (H)) terminals so that their terminal signals match with each other. (Incorrect connection will damage the inverter.)</p> <p>*2. When the power supply is 400V class, install a step-down transformer.</p>																																																																																																					
<p>*3. Minimize the cable length between the inverter and brake unit and the resistor unit and brake unit. Use a twisted cable when the wiring length exceeds 5m. (If twisted wires are used, the distance should be within 10m.) Use the wires of the above recommended size or larger.</p>																																																																																																					

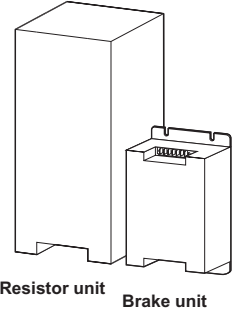

Name (type) Specifications, Structure, etc.

- The brake unit and resistor unit are options that will fully exhibit the regenerative braking capability of the inverter. Use them as a set.
- There are six different brake units as in the following table, from which make selection according to the deceleration time.
- When the brake unit duty (%ED) excess and an alarm occur, errors appear in the inverter.
- Brake unit selection table
  - %ED at short-time rating when braking torque is 100%
- Brake unit and resistor unit combinations and cables

Motor Capacity		75 kW	90 kW	110 kW	132 kW	160 kW	185 kW	220 kW	280 kW	375 kW	
Inverter	200V	75K	90K	110K	—	—	—	—	—	—	
	400V	75K	90K	110K	132K	160K	185K	220K	280K	375K	
Brake unit	200V	%ED	MT-BU5-55K	5	—	—	—	—	—	—	—
			MT-BU5-110K	20	15	10	—	—	—	—	—
	400V	%ED	MT-BU5-H75K	10	5	—	—	—	—	—	—
			MT-BU5-H150K	40	25	20	10	5	5	—	—
			MT-BU5-H220K	80	60	40	25	15	10	10	5
			MT-BU5-H280K	—	80	65	40	30	20	15	10
MT-BU5-H375K	—	—	—	80	50	40	20	15	10		

Brake Unit Type	Resistor unit type	Cable	
200V	MT-BU5-55K	MT-BR5-55K	14mm <sup>2</sup>
	MT-BU5-110K	2×MT-BR5-55K	2×14mm <sup>2</sup>
400V	MT-BU5-H75K	MT-BR5-H75K	14mm <sup>2</sup>
	MT-BU5-H150K	2×MT-BR5-H75K	2×14mm <sup>2</sup>
	MT-BU5-H220K	3×MT-BR5-H75K	3×14mm <sup>2</sup>
	MT-BU5-H280K	4×MT-BR5-H75K	4×14mm <sup>2</sup>
MT-BU5-H375K	5×MT-BR5-H75K	5×14mm <sup>2</sup>	

• Braking torque (%) at short-time rating

Motor Capacity		75 kW	90 kW	110 kW	132 kW	160 kW	185 kW	220 kW	280 kW	375 kW	
Inverter	200V	75K	90K	110K	—	—	—	—	—	—	
	400V	75K	90K	110K	132K	160K	185K	220K	280K	375K	
Brake unit	200V	braking torque (%)	MT-BU5-55K	70	60	50	—	—	—	—	—
			MT-BU5-110K	150	120	100	—	—	—	—	—
	400V	braking torque (%)	MT-BU5-H75K	100	80	70	55	45	40	35	25
			MT-BU5-H150K	150	150	135	110	90	80	70	50
			MT-BU5-H220K	150	150	150	150	135	115	100	80
			MT-BU5-H280K	150	150	150	150	150	150	125	100
MT-BU5-H375K	150	150	150	150	150	150	150	130			

- (Caution 1) Be sure to select the well-ventilated place for installation of the resistor unit. Ventilation is necessary when installing the resistor in a place, e.g. enclosure, where heat is not well diffused.
- (Caution 2) The temperature rise of the discharging resistor is 300deg. Therefore, wire the cable so as not to touch the resistor. In addition, separate the parts with low heat resistance and the resistor by at least 40 to 50cm.
- (Caution 3) The temperature of the resistor unit abnormally increases if the brake unit is operated exceeding the specified duty. Since the resistor unit may result in overheat if the temperature of the brake unit is left unchanged, switch off the inverter.
- \* The resistor unit is provided with a thermostat (a contact) as overheat protection. If this protective device is activated under normal operation, it is assumed that the deceleration time is too short. In such a case, increase the deceleration time setting of the inverter.

\* To obtain a large braking torque, the motor has to have a torque characteristic that meets the braking torque.  
Check the torque characteristic of the motor.

• Outline dimension drawings

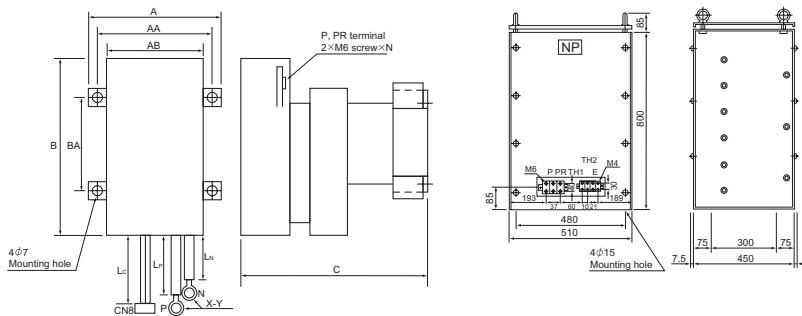

Brake Unit Type	A	AA	AB	B	BA	C	Lc	LP	LN	N	Approx. mass	X	Y	Z	
200V class	MT-BU5-55K	118	102	90	200	100	256.5	550	1740	1740	1	1.5	14	12	8
	MT-BU5-110K	188	172	160	200	100	256.5	550	2000	2000	2	3.0	22	12	8
400V class	MT-BU5-H75K	118	102	90	200	100	256.5	550	1740	1740	1	1.5	14	12	8
	MT-BU5-H150K	188	172	160	200	100	256.5	550	2000	2000	2	3.0	22	12	8
	MT-BU5-H220K	258	242	230	200	100	256.5	550	2000	2000	3	4.5	38	12	8
	MT-BU5-H280K	328	312	300	200	100	256.5	550	2330	2330	4	6.0	60	12	10
MT-BU5-H375K	398	382	370	200	100	256.5	550	2330	2330	5	7.5	60	12	10	

Resistor unit type	Resistance value	mass
200V class MT-BR5-55K	2.0Ω	50kg
400V class MT-BR5-H75K	6.5Ω	70kg

• External connection diagram

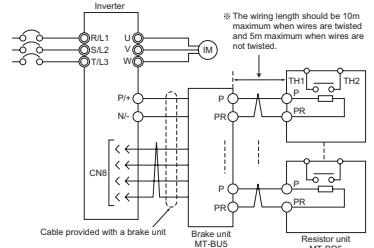

- (Caution 1) For wiring of the brake unit and inverter, use an accessory cable supplied with the brake unit. Connect the main circuit cable to the terminals P/+ and N/- and connect the control circuit cable to the connector (CNB) inside by making cuts in the rubber bush at the top of the inverter.
- (Caution 2) The brake unit which uses multiple resistor units has terminals equal to the number of resistor units. Connect one resistor unit to one pair of terminals (P, PR).

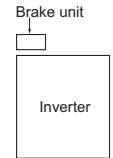

Brake unit  
MT-BU5-(H)□□K  
Resistor unit  
MT-BR5-(H)□□K

- Features
- Peripheral Devices Why energy savings?
- Standard Specifications
- Outline Dimension Drawings
- Terminal Connection Diagram Terminal Specification Explanation
- Operation Panel
- Parameter List
- Explanations of Parameters
- Protective Functions
- Options
- Instructions
- Motor
- Compatibility
- Warranty
- Inquiry

Name (type)	Specifications, Structure, etc.																																																																																																																																																																							
<p>Power regeneration common converter FR-CV-(H)□□K</p>	<ul style="list-style-type: none"> <li>Enables 100%-torque continuous regeneration to support continuous regenerative operation for line control, etc.</li> <li>Eliminates the need to use a brake unit with each inverter, reducing total space and total cost.</li> <li>Saves energy since regeneration energy is used for the other inverters and excess energy is returned to the power supply.</li> <li>Connection example</li> </ul> <p> <b>FR-CV-(H)</b> (Unit mm)         <table border="1"> <thead> <tr> <th>Voltage/Capacity</th> <th>W</th> <th>D</th> <th>D1</th> <th>H</th> <th>Voltage/Capacity</th> <th>W</th> <th>D</th> <th>D1</th> <th>H</th> </tr> </thead> <tbody> <tr> <td>27.5K/11K</td> <td>90</td> <td>303</td> <td>103</td> <td>300</td> <td>47.5K/15K</td> <td>120</td> <td>305</td> <td>105</td> <td>300</td> </tr> <tr> <td>015K</td> <td>120</td> <td>305</td> <td>105</td> <td>300</td> <td>022K/30K</td> <td>150</td> <td>322</td> <td>122</td> <td>380</td> </tr> <tr> <td>022K/30K</td> <td>150</td> <td>322</td> <td>122</td> <td>380</td> <td>037K/55K</td> <td>400</td> <td>250</td> <td>135</td> <td>620</td> </tr> <tr> <td>037K/55K</td> <td>400</td> <td>250</td> <td>135</td> <td>620</td> <td></td> <td></td> <td></td> <td></td> <td></td> </tr> </tbody> </table> </p> <p> <b>FR-CV-(H)-AT</b> (Unit mm)         <table border="1"> <thead> <tr> <th>Voltage/Capacity</th> <th>W</th> <th>D</th> <th>D1</th> <th>H</th> <th>Voltage/Capacity</th> <th>W</th> <th>D</th> <th>D1</th> <th>H</th> </tr> </thead> <tbody> <tr> <td>27.5K/11K</td> <td>110</td> <td>315</td> <td>115</td> <td>330</td> <td>47.5K/15K</td> <td>130</td> <td>320</td> <td>120</td> <td>330</td> </tr> <tr> <td>015K</td> <td>130</td> <td>320</td> <td>120</td> <td>330</td> <td>022K/30K</td> <td>160</td> <td>350</td> <td>150</td> <td>410</td> </tr> <tr> <td>022K/30K</td> <td>160</td> <td>350</td> <td>150</td> <td>410</td> <td></td> <td></td> <td></td> <td></td> <td></td> </tr> </tbody> </table> </p> <p> <b>FR-CV-(H)-AT</b> (Unit mm)         <table border="1"> <thead> <tr> <th>Voltage/Capacity</th> <th>W</th> <th>D</th> <th>D1</th> <th>H</th> <th>Voltage/Capacity</th> <th>W</th> <th>D</th> <th>D1</th> <th>H</th> </tr> </thead> <tbody> <tr> <td>27.5K/11K</td> <td>110</td> <td>315</td> <td>115</td> <td>330</td> <td>47.5K/15K</td> <td>130</td> <td>320</td> <td>120</td> <td>330</td> </tr> <tr> <td>015K</td> <td>130</td> <td>320</td> <td>120</td> <td>330</td> <td>022K/30K</td> <td>160</td> <td>350</td> <td>150</td> <td>410</td> </tr> <tr> <td>022K/30K</td> <td>160</td> <td>350</td> <td>150</td> <td>410</td> <td></td> <td></td> <td></td> <td></td> <td></td> </tr> </tbody> </table> </p> <p>             *1. Remove the jumpers across terminals R/L1-R1/L11 and S/L2-S1/L21 of the inverter, and connect the control circuit power supply across terminals R1/L11-S1/L21. Always keep the power input terminals R/L1, S/L2, T/L3 open. Incorrect connection will damage the inverter. Opposite polarity of terminals N/-, P/+ will damage the inverter.              *2. Do not insert an NFB between the terminals P/+-N/- (between P/L+-P/+, between N/L--N/-).              *3. Assign the terminal for X10 signal using any of Pr. 178 to Pr. 189 (input terminal function selection).              *4. Be sure to connect the power supply and terminals R/L11, S/L21, T/MC1. If the inverter is operated without connection, the power regeneration common converter will be damaged.         </p>	Voltage/Capacity	W	D	D1	H	Voltage/Capacity	W	D	D1	H	27.5K/11K	90	303	103	300	47.5K/15K	120	305	105	300	015K	120	305	105	300	022K/30K	150	322	122	380	022K/30K	150	322	122	380	037K/55K	400	250	135	620	037K/55K	400	250	135	620						Voltage/Capacity	W	D	D1	H	Voltage/Capacity	W	D	D1	H	27.5K/11K	110	315	115	330	47.5K/15K	130	320	120	330	015K	130	320	120	330	022K/30K	160	350	150	410	022K/30K	160	350	150	410						Voltage/Capacity	W	D	D1	H	Voltage/Capacity	W	D	D1	H	27.5K/11K	110	315	115	330	47.5K/15K	130	320	120	330	015K	130	320	120	330	022K/30K	160	350	150	410	022K/30K	160	350	150	410																																										
Voltage/Capacity	W	D	D1	H	Voltage/Capacity	W	D	D1	H																																																																																																																																																															
27.5K/11K	90	303	103	300	47.5K/15K	120	305	105	300																																																																																																																																																															
015K	120	305	105	300	022K/30K	150	322	122	380																																																																																																																																																															
022K/30K	150	322	122	380	037K/55K	400	250	135	620																																																																																																																																																															
037K/55K	400	250	135	620																																																																																																																																																																				
Voltage/Capacity	W	D	D1	H	Voltage/Capacity	W	D	D1	H																																																																																																																																																															
27.5K/11K	110	315	115	330	47.5K/15K	130	320	120	330																																																																																																																																																															
015K	130	320	120	330	022K/30K	160	350	150	410																																																																																																																																																															
022K/30K	160	350	150	410																																																																																																																																																																				
Voltage/Capacity	W	D	D1	H	Voltage/Capacity	W	D	D1	H																																																																																																																																																															
27.5K/11K	110	315	115	330	47.5K/15K	130	320	120	330																																																																																																																																																															
015K	130	320	120	330	022K/30K	160	350	150	410																																																																																																																																																															
022K/30K	160	350	150	410																																																																																																																																																																				
<p>High power factor converter FR-HC- (H)□□K</p>	<ul style="list-style-type: none"> <li>Substantially suppresses power harmonics to realize the equivalent capacity conversion coefficient K5=0 in the "Harmonic suppression guideline for specific consumers".</li> <li>Has the power regeneration function as standard.</li> <li>Connects multiple inverters to enable common converter system operation.</li> </ul> <p> <b>Specifications</b> <table border="1"> <thead> <tr> <th rowspan="2">Inverter Type FR-HC□□</th> <th colspan="4">200V</th> <th colspan="4">400V</th> </tr> <tr> <th>7.5K</th> <th>15K</th> <th>30K</th> <th>55K</th> <th>H7.5K</th> <th>H15K</th> <th>H30K</th> <th>H55K</th> </tr> </thead> <tbody> <tr> <td>Applied inverter capacity (*1)</td> <td>3.7K to 7.5K</td> <td>7.5K to 15K</td> <td>15K to 30K</td> <td>30K to 55K</td> <td>3.7K to 7.5K</td> <td>7.5K to 15K</td> <td>15K to 30K</td> <td>30K to 55K</td> </tr> <tr> <td>Rated input voltage/frequency</td> <td colspan="4">Three phase 200V to 220V 50Hz 200V to 230V 60Hz</td> <td colspan="4">Three phase 380V to 460V 50/60Hz</td> </tr> <tr> <td>Rated input current (A)</td> <td>33</td> <td>61</td> <td>115</td> <td>215</td> <td>17</td> <td>31</td> <td>57</td> <td>110</td> </tr> <tr> <td>Rated output voltage (V) (*2)</td> <td colspan="4">293VDC to 335VDC</td> <td colspan="4">558VDC to 670VDC</td> </tr> </tbody> </table> </p> <p> <b>Outline dimension</b> (Unit: mm)         <table border="1"> <thead> <tr> <th rowspan="2">Voltage</th> <th rowspan="2">Capacity</th> <th colspan="3">High Power Factor Converter FR-HC</th> <th colspan="3">Reactor 1 FR-HCL01</th> <th colspan="3">Reactor 2 FR-HCL02</th> <th colspan="3">Outside Box FR-HCB</th> </tr> <tr> <th>W</th> <th>H</th> <th>D</th> <th>W</th> <th>H</th> <th>D</th> <th>W</th> <th>H</th> <th>D</th> <th>W</th> <th>H</th> <th>D</th> </tr> </thead> <tbody> <tr> <td rowspan="4">200V</td> <td>7.5K</td> <td>220</td> <td>300</td> <td>190</td> <td>160</td> <td>155</td> <td>100</td> <td>240</td> <td>230</td> <td>160</td> <td rowspan="4">190</td> <td rowspan="4">320</td> <td rowspan="4">165</td> </tr> <tr> <td>15K</td> <td>250</td> <td>400</td> <td>190</td> <td>190</td> <td>205</td> <td>130</td> <td>260</td> <td>270</td> <td>170</td> </tr> <tr> <td>30K</td> <td>340</td> <td>550</td> <td>195</td> <td>220</td> <td>230</td> <td>170</td> <td>340</td> <td>320</td> <td>180</td> </tr> <tr> <td>55K</td> <td>480</td> <td>700</td> <td>250</td> <td>210</td> <td>260</td> <td>225</td> <td>430</td> <td>470</td> <td>360</td> </tr> <tr> <td rowspan="4">400V</td> <td>H7.5K</td> <td>220</td> <td>300</td> <td>190</td> <td>160</td> <td>150</td> <td>100</td> <td>240</td> <td>220</td> <td>160</td> <td rowspan="4">190</td> <td rowspan="4">320</td> <td rowspan="4">165</td> </tr> <tr> <td>H15K</td> <td>250</td> <td>400</td> <td>190</td> <td>190</td> <td>195</td> <td>130</td> <td>260</td> <td>260</td> <td>170</td> </tr> <tr> <td>H30K</td> <td>340</td> <td>550</td> <td>195</td> <td>220</td> <td>215</td> <td>140</td> <td>340</td> <td>310</td> <td>180</td> </tr> <tr> <td>H55K</td> <td>480</td> <td>700</td> <td>250</td> <td>280</td> <td>255</td> <td>190</td> <td>400</td> <td>380</td> <td>285</td> </tr> </tbody> </table> </p> <p>             *1. The applicable capacity to the high power factor converter is the total capacity of the inverters.              *2. The output voltage varies with the input voltage value.         </p>	Inverter Type FR-HC□□	200V				400V				7.5K	15K	30K	55K	H7.5K	H15K	H30K	H55K	Applied inverter capacity (*1)	3.7K to 7.5K	7.5K to 15K	15K to 30K	30K to 55K	3.7K to 7.5K	7.5K to 15K	15K to 30K	30K to 55K	Rated input voltage/frequency	Three phase 200V to 220V 50Hz 200V to 230V 60Hz				Three phase 380V to 460V 50/60Hz				Rated input current (A)	33	61	115	215	17	31	57	110	Rated output voltage (V) (*2)	293VDC to 335VDC				558VDC to 670VDC				Voltage	Capacity	High Power Factor Converter FR-HC			Reactor 1 FR-HCL01			Reactor 2 FR-HCL02			Outside Box FR-HCB			W	H	D	W	H	D	W	H	D	W	H	D	200V	7.5K	220	300	190	160	155	100	240	230	160	190	320	165	15K	250	400	190	190	205	130	260	270	170	30K	340	550	195	220	230	170	340	320	180	55K	480	700	250	210	260	225	430	470	360	400V	H7.5K	220	300	190	160	150	100	240	220	160	190	320	165	H15K	250	400	190	190	195	130	260	260	170	H30K	340	550	195	220	215	140	340	310	180	H55K	480	700	250	280	255	190	400	380	285
Inverter Type FR-HC□□	200V				400V																																																																																																																																																																			
	7.5K	15K	30K	55K	H7.5K	H15K	H30K	H55K																																																																																																																																																																
Applied inverter capacity (*1)	3.7K to 7.5K	7.5K to 15K	15K to 30K	30K to 55K	3.7K to 7.5K	7.5K to 15K	15K to 30K	30K to 55K																																																																																																																																																																
Rated input voltage/frequency	Three phase 200V to 220V 50Hz 200V to 230V 60Hz				Three phase 380V to 460V 50/60Hz																																																																																																																																																																			
Rated input current (A)	33	61	115	215	17	31	57	110																																																																																																																																																																
Rated output voltage (V) (*2)	293VDC to 335VDC				558VDC to 670VDC																																																																																																																																																																			
Voltage	Capacity	High Power Factor Converter FR-HC			Reactor 1 FR-HCL01			Reactor 2 FR-HCL02			Outside Box FR-HCB																																																																																																																																																													
		W	H	D	W	H	D	W	H	D	W	H	D																																																																																																																																																											
200V	7.5K	220	300	190	160	155	100	240	230	160	190	320	165																																																																																																																																																											
	15K	250	400	190	190	205	130	260	270	170																																																																																																																																																														
	30K	340	550	195	220	230	170	340	320	180																																																																																																																																																														
	55K	480	700	250	210	260	225	430	470	360																																																																																																																																																														
400V	H7.5K	220	300	190	160	150	100	240	220	160	190	320	165																																																																																																																																																											
	H15K	250	400	190	190	195	130	260	260	170																																																																																																																																																														
	H30K	340	550	195	220	215	140	340	310	180																																																																																																																																																														
	H55K	480	700	250	280	255	190	400	380	285																																																																																																																																																														

Name (type)	Specifications, Structure, etc.																																																																																																																																																							
<p>Sine wave filter MT-BSL-(H)□□K MT-BSC-(H)□□K</p>	<p>● Application of the sine wave filter For the FR-F700 series (75K or more) inverter, the motor voltage and current can be made to nearly sine wave shaped by providing a sine wave filter on the output side.</p> <p>1) Low noise 2) Surgeless 3) Motor loss reduction (use of standard motor)</p> <p>● Application condition The following conditions have to be satisfied to install the sine wave filter.</p> <p>1) Change the Pr: 72 setting to "25". (The initial value is "2".) The carrier frequency changes to 2.5KHz. (The sine wave filter is designed on condition that the carrier frequency is 2.5KHz. Be sure to change the setting property.) If the inverter is operated with Pr.72 set to other than "25", the inverter and sine wave filter may be damaged.</p> <p>2) The sine wave filter can be used only for 60 Hz or less inverter frequency. Note that the filter can not be used for the higher frequency operation than this. (Otherwise the filter loss will increase. )</p> <p>3) Use the inverter with capacity one rank higher. *2 4) Install an external thermal relay of the motor.</p> <p>● Circuit configuration and connection</p>																																																																																																																																																							
	<div style="display: flex; justify-content: space-between;"> <div style="width: 45%;"> <p>*Install the filter near the inverter. For a capacitor cable, use a cable with size larger than indicated in the table below *recommended cable size*.</p> </div> <div style="width: 45%;"> <table border="1"> <thead> <tr> <th rowspan="2">Motor capacity (kW)</th> <th rowspan="2">Inverter type</th> <th colspan="2">Applied Inverter (*2)</th> </tr> <tr> <th>Reactor for filter</th> <th>Capacitor for filter</th> </tr> </thead> <tbody> <tr> <td rowspan="2">200V class</td> <td>75 MT-BSL-75K</td> <td>1×MT-BSC-75K</td> <td>FR-F720-90K</td> </tr> <tr> <td>90 MT-BSL-90K</td> <td>1×MT-BSC-90K</td> <td>FR-F720-110K</td> </tr> <tr> <td rowspan="8">400V class</td> <td>75 MT-BSL-H75K</td> <td>1×MT-BSC-H75K</td> <td>FR-F740-90K</td> </tr> <tr> <td>90 MT-BSL-H110K</td> <td>1×MT-BSC-H110K</td> <td>FR-F740-110K</td> </tr> <tr> <td>110 MT-BSL-H110K</td> <td>1×MT-BSC-H110K</td> <td>FR-F740-132K</td> </tr> <tr> <td>132 MT-BSL-H150K</td> <td>2×MT-BSC-H75K</td> <td>FR-F740-160K</td> </tr> <tr> <td>160 MT-BSL-H220K</td> <td>2×MT-BSC-H110K</td> <td>FR-F740-185K</td> </tr> <tr> <td>185 MT-BSL-H220K</td> <td>2×MT-BSC-H110K</td> <td>FR-F740-220K</td> </tr> <tr> <td>220 MT-BSL-H220K</td> <td>2×MT-BSC-H110K</td> <td>FR-F740-250K</td> </tr> <tr> <td>250 MT-BSL-H280K</td> <td>3×MT-BSC-H110K</td> <td>FR-F740-280K</td> </tr> <tr> <td>280 MT-BSL-H280K</td> <td>3×MT-BSC-H110K</td> <td>FR-F740-315K</td> </tr> </tbody> </table> <p>*1 For the 2 ×, connect capacitors in parallel as in the connection diagram. *2 If the rated motor current × (1.05 to 1.1) is less than 80% of the inverter rated current, an inverter with same kW with a motor can be used.</p> </div> </div>	Motor capacity (kW)	Inverter type	Applied Inverter (*2)		Reactor for filter	Capacitor for filter	200V class	75 MT-BSL-75K	1×MT-BSC-75K	FR-F720-90K	90 MT-BSL-90K	1×MT-BSC-90K	FR-F720-110K	400V class	75 MT-BSL-H75K	1×MT-BSC-H75K	FR-F740-90K	90 MT-BSL-H110K	1×MT-BSC-H110K	FR-F740-110K	110 MT-BSL-H110K	1×MT-BSC-H110K	FR-F740-132K	132 MT-BSL-H150K	2×MT-BSC-H75K	FR-F740-160K	160 MT-BSL-H220K	2×MT-BSC-H110K	FR-F740-185K	185 MT-BSL-H220K	2×MT-BSC-H110K	FR-F740-220K	220 MT-BSL-H220K	2×MT-BSC-H110K	FR-F740-250K	250 MT-BSL-H280K	3×MT-BSC-H110K	FR-F740-280K	280 MT-BSL-H280K	3×MT-BSC-H110K	FR-F740-315K																																																																																																														
Motor capacity (kW)	Inverter type			Applied Inverter (*2)																																																																																																																																																				
		Reactor for filter	Capacitor for filter																																																																																																																																																					
200V class	75 MT-BSL-75K	1×MT-BSC-75K	FR-F720-90K																																																																																																																																																					
	90 MT-BSL-90K	1×MT-BSC-90K	FR-F720-110K																																																																																																																																																					
400V class	75 MT-BSL-H75K	1×MT-BSC-H75K	FR-F740-90K																																																																																																																																																					
	90 MT-BSL-H110K	1×MT-BSC-H110K	FR-F740-110K																																																																																																																																																					
	110 MT-BSL-H110K	1×MT-BSC-H110K	FR-F740-132K																																																																																																																																																					
	132 MT-BSL-H150K	2×MT-BSC-H75K	FR-F740-160K																																																																																																																																																					
	160 MT-BSL-H220K	2×MT-BSC-H110K	FR-F740-185K																																																																																																																																																					
	185 MT-BSL-H220K	2×MT-BSC-H110K	FR-F740-220K																																																																																																																																																					
	220 MT-BSL-H220K	2×MT-BSC-H110K	FR-F740-250K																																																																																																																																																					
	250 MT-BSL-H280K	3×MT-BSC-H110K	FR-F740-280K																																																																																																																																																					
280 MT-BSL-H280K	3×MT-BSC-H110K	FR-F740-315K																																																																																																																																																						
<p>● Reactor for sine wave filter</p>	<p>● Capacitor for sine wave filter</p>																																																																																																																																																							
<table border="1"> <thead> <tr> <th rowspan="2">Inverter type</th> <th>A</th> <th>B</th> <th>C</th> <th>D</th> <th>E</th> <th>F</th> <th>G</th> <th>H</th> <th>Mass (kg)</th> </tr> </thead> <tbody> <tr> <td>200V class</td> <td>MT-BSL-75K</td> <td>330</td> <td>150</td> <td>285</td> <td>185</td> <td>216</td> <td>328</td> <td>M10</td> <td>M12</td> <td>80</td> </tr> <tr> <td></td> <td>MT-BSL-90K</td> <td>390</td> <td>150</td> <td>320</td> <td>180</td> <td>220</td> <td>330</td> <td>M12</td> <td>M12</td> <td>105</td> </tr> <tr> <td rowspan="4">400V class</td> <td>MT-BSL-H75K</td> <td>330</td> <td>150</td> <td>285</td> <td>185</td> <td>216</td> <td>318</td> <td>M10</td> <td>M10</td> <td>80</td> </tr> <tr> <td>MT-BSL-H110K</td> <td>390</td> <td>150</td> <td>340</td> <td>195</td> <td>235</td> <td>368</td> <td>M12</td> <td>M12</td> <td>140</td> </tr> <tr> <td>MT-BSL-H150K</td> <td>455</td> <td>200</td> <td>397</td> <td>200</td> <td>240</td> <td>380</td> <td>M12</td> <td>M12</td> <td>190</td> </tr> <tr> <td>MT-BSL-H220K</td> <td>495</td> <td>200</td> <td>405</td> <td>250</td> <td>300</td> <td>420</td> <td>M12</td> <td>M12</td> <td>240</td> </tr> <tr> <td></td> <td>MT-BSL-H280K</td> <td>575</td> <td>200</td> <td>470</td> <td>310</td> <td>370</td> <td>485</td> <td>M12</td> <td>M12</td> <td>340</td> </tr> </tbody> </table>	Inverter type	A	B	C	D	E	F	G	H	Mass (kg)	200V class	MT-BSL-75K	330	150	285	185	216	328	M10	M12	80		MT-BSL-90K	390	150	320	180	220	330	M12	M12	105	400V class	MT-BSL-H75K	330	150	285	185	216	318	M10	M10	80	MT-BSL-H110K	390	150	340	195	235	368	M12	M12	140	MT-BSL-H150K	455	200	397	200	240	380	M12	M12	190	MT-BSL-H220K	495	200	405	250	300	420	M12	M12	240		MT-BSL-H280K	575	200	470	310	370	485	M12	M12	340	<table border="1"> <thead> <tr> <th rowspan="2">Inverter type</th> <th>A</th> <th>B</th> <th>C</th> <th>D</th> <th>E</th> <th>F</th> <th>G</th> <th>H</th> <th>I</th> <th>Mass (kg)</th> </tr> </thead> <tbody> <tr> <td>200V class</td> <td>MT-BSC-75K</td> <td>205</td> <td>190</td> <td>285</td> <td>230</td> <td>70</td> <td>40</td> <td>40</td> <td>φ7</td> <td>M6</td> <td>3.9</td> </tr> <tr> <td></td> <td>MT-BSC-90K</td> <td>280</td> <td>265</td> <td>270</td> <td>180</td> <td>90</td> <td>55</td> <td>80</td> <td>φ7</td> <td>M12</td> <td>5.5</td> </tr> <tr> <td>400V class</td> <td>MT-BSC-H75K</td> <td>205</td> <td>190</td> <td>220</td> <td>170</td> <td>70</td> <td>40</td> <td>50</td> <td>φ7</td> <td>M6</td> <td>3.0</td> </tr> <tr> <td></td> <td>MT-BSC-H110K</td> <td>205</td> <td>190</td> <td>280</td> <td>230</td> <td>70</td> <td>40</td> <td>50</td> <td>φ7</td> <td>M6</td> <td>4.0</td> </tr> </tbody> </table> <p>* Leave more than 25mm space between capacitors.</p> <p><b>Recommended cable size</b> The cable sizes between the Inverter and MT-BSL and between the MT-BSL and IM depend on U, V, W of "Peripheral devices list" (page 57) The cable size to the MT-BSC is as table below.</p> <table border="1"> <thead> <tr> <th>MT-BSC-75K</th> <th>MT-BSC-90K</th> <th>MT-BSC-H75K</th> <th>MT-BSC-H110K</th> </tr> </thead> <tbody> <tr> <td>38mm<sup>2</sup></td> <td>38mm<sup>2</sup></td> <td>22mm<sup>2</sup></td> <td>22mm<sup>2</sup></td> </tr> </tbody> </table>	Inverter type	A	B	C	D	E	F	G	H	I	Mass (kg)	200V class	MT-BSC-75K	205	190	285	230	70	40	40	φ7	M6	3.9		MT-BSC-90K	280	265	270	180	90	55	80	φ7	M12	5.5	400V class	MT-BSC-H75K	205	190	220	170	70	40	50	φ7	M6	3.0		MT-BSC-H110K	205	190	280	230	70	40	50	φ7	M6	4.0	MT-BSC-75K	MT-BSC-90K	MT-BSC-H75K	MT-BSC-H110K	38mm <sup>2</sup>	38mm <sup>2</sup>	22mm <sup>2</sup>	22mm <sup>2</sup>
Inverter type		A	B	C	D	E	F	G	H	Mass (kg)																																																																																																																																														
	200V class	MT-BSL-75K	330	150	285	185	216	328	M10	M12	80																																																																																																																																													
	MT-BSL-90K	390	150	320	180	220	330	M12	M12	105																																																																																																																																														
400V class	MT-BSL-H75K	330	150	285	185	216	318	M10	M10	80																																																																																																																																														
	MT-BSL-H110K	390	150	340	195	235	368	M12	M12	140																																																																																																																																														
	MT-BSL-H150K	455	200	397	200	240	380	M12	M12	190																																																																																																																																														
	MT-BSL-H220K	495	200	405	250	300	420	M12	M12	240																																																																																																																																														
	MT-BSL-H280K	575	200	470	310	370	485	M12	M12	340																																																																																																																																														
Inverter type	A	B	C	D	E	F	G	H	I	Mass (kg)																																																																																																																																														
	200V class	MT-BSC-75K	205	190	285	230	70	40	40	φ7	M6	3.9																																																																																																																																												
	MT-BSC-90K	280	265	270	180	90	55	80	φ7	M12	5.5																																																																																																																																													
400V class	MT-BSC-H75K	205	190	220	170	70	40	50	φ7	M6	3.0																																																																																																																																													
	MT-BSC-H110K	205	190	280	230	70	40	50	φ7	M6	4.0																																																																																																																																													
MT-BSC-75K	MT-BSC-90K	MT-BSC-H75K	MT-BSC-H110K																																																																																																																																																					
38mm <sup>2</sup>	38mm <sup>2</sup>	22mm <sup>2</sup>	22mm <sup>2</sup>																																																																																																																																																					

- Features
- Peripheral Devices  
Why energy savings?
- Standard Specifications
- Outline Dimension Drawing
- Terminal Connection Diagram  
Terminal Specification Explanation
- Operation Panel
- Parameter List
- Explanations of Parameters
- Protective Functions
- Options
- Instructions
- Motor
- Compatibility
- Warranty
- Inquiry

## Peripheral devices list

Voltage	Motor Output (kW) <sup>*1</sup>	Applicable Inverter Type	Moulded Case Circuit Breaker (MCCB) <sup>*2</sup> or Earth Leakage Circuit Breaker (ELB)			Input Side Magnetic Contactor <sup>*3</sup>		Recommended Cable Size (mm <sup>2</sup> ) <sup>*4</sup>	
			Reactor connection		Commercial-power supply operation available	Reactor connection		R, S, T	U, V, W
			without	with		without	with		
200V class	0.75	FR-F720-0.75K	30AF 10A	30AF 10A	30AF 10A	S-N10	S-N10	2	2
	1.5	FR-F720-1.5K	30AF 15A	30AF 15A	30AF 15A	S-N10	S-N10	2	2
	2.2	FR-F720-2.2K	30AF 20A	30AF 15A	30AF 20A	S-N10	S-N10	2	2
	3.7	FR-F720-3.7K	30AF 30A	30AF 30A	30AF 30A	S-N20, N21	S-N10	3.5	3.5
	5.5	FR-F720-5.5K	50AF 50A	50AF 40A	50AF 50A	S-N25	S-N20, N21	5.5	5.5
	7.5	FR-F720-7.5K	100AF 60A	50AF 50A	100AF 60A	S-N25	S-N25	14	8
	11	FR-F720-11K	100AF 75A	100AF 75A	100AF 75A	S-N35	S-N35	14	14
	15	FR-F720-15K	225AF 125A	100AF 100A	225AF 125A	S-N50	S-N50	22	22
	18.5	FR-F720-18.5K	225AF 150A	225AF 125A	225AF 150A	S-N65	S-N50	38	38
	22	FR-F720-22K	225AF 175A	225AF 150A	225AF 175A	S-N80	S-N65	38	38
	30	FR-F720-30K	225AF 225A	225AF 175A	225AF 225A	S-N95	S-N80	60	60
	37	FR-F720-37K	400AF 250A	225AF 225A	400AF 250A	S-N150	S-N125	80	80
	45	FR-F720-45K	400AF 300A	400AF 300A	400AF 350A	S-N180	S-N150	100	100
	55	FR-F720-55K	400AF 400A	400AF 350A	600AF 500A	S-N220	S-N180	100	100
	75	FR-F720-75K	—	400AF 400A	400AF 400A	—	S-N300	125	125
90	FR-F720-90K	—	400AF 400A	600AF 500A	—	S-N300	150	150	
110	FR-F720-110K	—	600AF 500A	600AF 600A	—	S-N400	2 × 100	2 × 100	
400V class	0.75	FR-F740-0.75K	30AF 5A	30AF 5A	30AF 5A	S-N10	S-N10	2	2
	1.5	FR-F740-1.5K	30AF 10A	30AF 10A	30AF 10A	S-N10	S-N10	2	2
	2.2	FR-F740-2.2K	30AF 10A	30AF 10A	30AF 15A	S-N10	S-N10	2	2
	3.7	FR-F740-3.7K	30AF 20A	30AF 15A	30AF 20A	S-N10	S-N10	2	2
	5.5	FR-F740-5.5K	30AF 30A	30AF 20A	30AF 30A	S-N20	S-N11, N12	2	2
	7.5	FR-F740-7.5K	30AF 30A	30AF 30A	30AF 30A	S-N20	S-N20	3.5	3.5
	11	FR-F740-11K	50AF 50A	50AF 40A	50AF 50A	S-N20	S-N20	5.5	5.5
	15	FR-F740-15K	100AF 60A	50AF 50A	100AF 60A	S-N25	S-N20	8	8
	18.5	FR-F740-18.5K	100AF 75A	100AF 60A	100AF 75A	S-N25	S-N25	14	8
	22	FR-F740-22K	100AF 100A	100AF 75A	100AF 100A	S-N35	S-N25	14	14
	30	FR-F740-30K	225AF 125A	225AF 100A	225AF 125A	S-N50	S-N50	22	22
	37	FR-F740-37K	225AF 150A	225AF 125A	225AF 150A	S-N65	S-N50	22	22
	45	FR-F740-45K	225AF 175A	225AF 150A	225AF 175A	S-N80	S-N65	38	38
	55	FR-F740-55K	225AF 200A	225AF 175A	225AF 200A	S-N80	S-N80	60	60
	75	FR-F740-75K	—	225AF 225A	225AF 225A	—	S-N95	60	60
	90	FR-F740-90K	—	225AF 225A	400AF 300A	—	S-N150	60	60
	110	FR-F740-110K	—	225AF 225A	400AF 350A	—	S-N180	80	80
	132	FR-F740-132K	—	400AF 400A	400AF 400A	—	S-N220	100	125
	160	FR-F740-160K	—	400AF 400A	600AF 500A	—	S-N300	125	125
	185	FR-F740-185K	—	400AF 400A	600AF 500A	—	S-N300	150	150
	220	FR-F740-220K	—	600AF 500A	600AF 600A	—	S-N400	2 × 100	2 × 100
250	FR-F740-250K	—	600AF 600A	600AF 600A	—	S-N600	2 × 100	2 × 100	
280	FR-F740-280K	—	600AF 600A	800AF 800A	—	S-N600	2 × 125	2 × 125	
315	FR-F740-315K	—	800AF 700A	800AF 800A	—	S-N600	2 × 150	2 × 150	
355	FR-F740-355K	—	800AF 800A	800AF 800A	—	S-N600	2 × 200	2 × 200	
400	FR-F740-400K	—	1000AF 900A	1000AF 1000A	—	S-N800	2 × 200	2 × 200	
450	FR-F740-450K	—	1000AF 1000A	1000AF 1000A	—	1000A rated product	2 × 250	2 × 250	
500	FR-F740-500K	—	1200AF 1200A	1200AF 1200A	—	1000A rated product	2 × 250	2 × 250	
560	FR-F740-560K	—	1600AF 1500A	1600AF 1600A	—	1200A rated product	3 × 200	3 × 200	

\*1 Selections for use of the Mitsubishi 4-pole standard motor with power supply voltage 200VAC (200V class)/400VAC (400V class) 50Hz.

\*2 Install one MCCB per inverter.  
For installations in the United States or Canada, use the fuse certified by the UL and cUL.  
(Refer to the Instruction Manual (basics).)

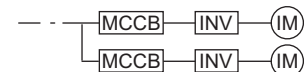

\*3 The electrical durability of magnetic contactor is 500,000 times. When the magnetic contactor is used for emergency stop during motor driving, the electrical durability is 25 times.  
When using the MC for emergency stop during motor driving or using on the motor side during commercial-power supply operation, select the MC with class AC-3 rated current for the motor rated current.

\*4 Cable  
For the 55K or less, the recommended cable size is that of the cable (HIV cable (600V class 2 vinyl-insulated cable) etc.) with continuous maximum permissible temperature of 75°C. Assumes that the ambient temperature is 50°C or less and the wiring distance is 20m or less.  
For the 75K or more, the recommended cable size is that of the cable (LMFC (heat resistant flexible cross-linked polyethylene insulated cable) etc.) with continuous maximum permissible temperature of 90°C or more. Assumes that the ambient temperature is 50°C or less and wiring is performed in an enclosure.



## ● Selection of rated sensitivity current of earth (ground) leakage breaker

When using the earth leakage circuit breaker with the inverter circuit, select its rated sensitivity current as follows, independently of the PWM carrier frequency:

- Breaker designed for harmonic and surge suppression  
Rated sensitivity current  $\Delta n \geq 10 \times (I_{g1} + I_{gn} + I_{gi} + I_{g2} + I_{gm})$
- Standard breaker  
Rated sensitivity current  $\Delta n \geq 10 \times (I_{g1} + I_{gn} + I_{gi} + 3 \times (I_{g2} + I_{gm}))$

$I_{g1}, I_{g2}$  : Leakage currents in wire path during commercial power supply operation

$I_{gn}$  : Leakage current of inverter input side noise filter

$I_{gm}$  : Leakage current of motor during commercial power supply operation

$I_{gi}$  : Inverter unit leakage current

Example of leakage current per 1km during the commercial power supply operation when the CV cable is routed in metal conduit

(Three-phase three-wire delta connection 400V/60Hz)

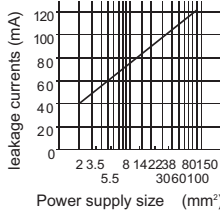

Leakage current example of Three-phase induction motor during the commercial power supply operation

(Totally-enclosed fan-cooled type motor 400V/60Hz)

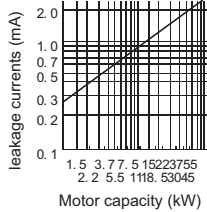

For "Δ" connection, the amount of leakage current is 1/3

example

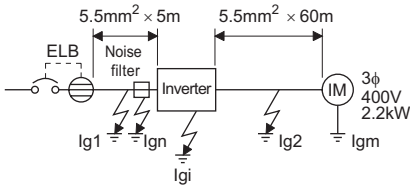

(Note)1. Install the earth leakage breaker (ELB) on the input side of the inverter.

2. In the Δ connection earthed-neutral system, the sensitivity current is purified against an earth (ground) fault in the inverter output side. Earthing (Grounding) must conform to the requirements of national and local safety regulations and electrical codes. (JIS, NEC section 250, IEC 536 class 1 and other applicable standards)

## ● Selection example (in the case of the left figure)

	Breaker Designed for Harmonic and Surge Suppression	Standard Breaker
Leakage current $I_{g1}$ (mA)	$\frac{1}{3} \times 66 \times \frac{5m}{1000m} = 0.11$	
Leakage current $I_{gn}$ (mA)	0 (without noise filter)	
Leakage current $I_{gi}$ (mA)	1 (Without EMC filter) Refer to the following table for the leakage current of the inverter	
Leakage current $I_{g2}$ (mA)	$\frac{1}{3} \times 66 \times \frac{60m}{1000m} = 1.32$	
Motor leakage current $I_{gm}$ (mA)	0.36	
Total leakage current (mA)	2.79	6.15
Rated sensitivity current (mA) ( $\geq I_g \times 10$ )	30	100

## ● Inverter leakage current (with and without EMC filter)

Input power conditions  
(200V class : 220V/60Hz, 400V class : 440V/60Hz, power supply unbalance within 3%)

	Voltage (V)	EMC Filter	
		ON (mA)	OFF (mA)
Phase grounding	200	22(1) *	1
	400	30	1
Earthed-neutral system	400	1	1

\* For the 200V class 0.75K and 1.5K, the EMC filter is always valid. The leakage current is 1mA.

- Features
- Peripheral Devices  
Why energy savings?
- Standard Specifications
- Outline Dimension Drawings
- Terminal Connection Diagram  
Terminal Specification Explanation
- Operation Panel
- Parameter List
- Explanations of Parameters
- Protective Functions
- Options
- Instructions
- Motor
- Compatibility
- Warranty
- Inquiry

## Precautions for Operation/Selection

### Precautions for use of the inverter

#### ⚠ Safety Precautions

- To operate the inverter correctly and safely, be sure to read the "instruction manual" before starting operation.
- This product has not been designed or manufactured for use with any equipment or system operated under life-threatening conditions.
- Please contact our sales office when you are considering using this product in special applications such as passenger mobile, medical, aerospace, nuclear, power or undersea relay equipment or system.
- Although this product is manufactured under strict quality control, safety devices should be installed when a serious accident or loss is expected by a failure of this product.
- The load used should be a three-phase induction motor only.

#### ● Operation

- A magnetic contactor (MC) provided on the primary side should not be used to make frequent starts and stops. It could cause the inverter to fail.
- However, at this time, the motor cannot be brought to a sudden stop. Hence, provide a mechanical stopping/holding mechanism for the machine/equipment which requires an emergency stop.
- It will take time for the capacitor to discharge after shutoff of the inverter power supply. When accessing the inverter for inspection, wait for at least 10 minutes after the power supply has been switched off, and check to make sure that there are no residual voltage using a tester or the like.

#### ● Wiring

- Application of power to the output terminals (U, V, W) of the inverter will damage the inverter. Therefore, fully check the wiring and sequence to ensure that wiring is correct, etc. before powering on.
- The terminals P/+ , P1, N/- are provided for connection of a dedicated option. Connect only a dedicated option. Do not short the frequency setting power supply terminal 10 and common terminal 5 or the terminal PC and terminal SD.
- Do not wire the maker-dedicated terminal PR/PX.

#### ● Installation

- Avoid hostile environment where oil mist, fluff, dust particles, etc. are suspended in the air, and install the inverter in a clean place or put it in an ingress-protected "enclosed" panel. When placing the inverter in a panel, determine the cooling system and panel dimensions so that the ambient temperature of the inverter is within the permissible value. (refer to page 8 for the specified value)
- Do not install the inverter on wood or other combustible material as it will be hot locally.
- Install the inverter in the vertical orientation.

#### ● Setting

- The inverter can be operated as fast as a maximum of 400Hz by parameter setting. Therefore, incorrect setting can cause a danger. Set the upper limit using the maximum frequency limit setting function.
- A setting higher than the initial value of DC injection brake operation voltage or operation time can cause motor overheat (electronic thermal relay trip).

### Precautions for selection

#### ● Inverter capacity selection

- When operating a special motor or more than one motor in parallel with a single inverter, select the inverter capacity so that 1.1 times the total rated motor current is less than the rated output current of the inverter.

#### ● Starting torque of the motor

- The start and acceleration characteristics of the motor driven by the inverter are restricted by the overload current rating of that inverter. Generally the torque characteristic is less than when the motor is started by a commercial power supply. When torque boost adjustment or simple magnetic flux vector cannot provide enough starting torque, select the inverter of one rank higher capacity or increase the capacities of both the motor and inverter.

#### ● Acceleration and deceleration times

- The acceleration/deceleration time of the motor depends on the motor-generated torque, load torque and moment of inertia of the load ( $GD^2$ ).
- When the current limit function or stall prevention function is activated during acceleration/deceleration, increase the acceleration/deceleration time as the actual time may become longer.
- To decrease the acceleration/deceleration time, increase the torque boost value (setting of a too large value may activate the stall prevention function at a start, longer the acceleration time), use the simple magnetic flux vector control, or increase the inverter and motor capacities. To decrease the deceleration time, it is necessary to add the brake unit (FR-BU, MT-BU5), power regeneration common converter (FR-CV), power regeneration unit (MT-RC) or a similar device to absorb braking energy.

#### ● Power transfer mechanism (gear, belt, chain, etc.)

- When an oil-lubricated gear box, speed change gear or similar device is used in the power transfer system, note that continuous operation at low decelerated speed only may deteriorate oil lubrication, causing seizure. When performing fast operation at higher than 60Hz, fully note that such operation will cause strength shortage due to the noise, life or centrifugal force of the power transfer mechanism.

#### ● Instructions for overload operation

- When performing operation of frequent start/stop of the inverter, rise/fall in the temperature of the transistor element of the inverter will repeat due to a continuous flow of large current, shortening the life from thermal fatigue. Since thermal fatigue is related to the amount of current, the life can be increased by reducing bound current, starting current, etc. Decreasing current may increase the life. However, decreasing current will result in insufficient torque and the inverter may not start. Therefore, increase the inverter capacity to have enough allowance for current.

## Precautions for Peripheral Device Selection

### ● Installation and selection of moulded case circuit breaker

Install a moulded case circuit breaker (MCCB) on the power receiving side to protect the wiring of the inverter primary side. For MCCB selection, refer to *page 57* since it depends on the inverter power supply side power factor (which changes depending on the power supply voltage, output frequency and load). Note that the operation characteristics of the completely electromagnetic MCCB changes according to the higher harmonic current, so a larger capacity must be selected. (Check it in the data of the corresponding breaker.) As an earth (ground) leakage breaker, use the Mitsubishi earth (ground) leakage breaker designed for harmonics and surges. (*Refer to page 58.*)

When installing a moulded case circuit breaker on the secondary side of the inverter, contact each manufacturer for selection of the moulded case circuit breaker.

### ● Handling of primary side magnetic contactor

For operation via external terminal (terminal STF or STR used), provide a primary side MC to prevent an accident caused by a natural restart at power recovery after a power failure, such as an instantaneous power failure, and to ensure safety for maintenance work. Do not use this magnetic contactor to make frequent starts and stops. (The switching life of the inverter input circuit is about 1,000,000 times.) For parameter unit operation, an automatic restart after power failure is not made and the MC cannot be used to make a start. Note that the primary side MC can stop the operation, but the regenerative brake specific to the inverter does not operate and the motor coasts to stop.

### ● Handling of secondary side magnetic contactor

Switch the magnetic contactor between the inverter and motor only when both the inverter and motor are at a stop. When the magnetic contactor is turned on while the inverter is operating, overcurrent protection of the inverter and such will activate. When an MC is provided to switch to a commercial power supply, for example, it is recommended to use commercial power supply-inverter switchover operation *Pr. 135 to 139*.

### ● Thermal relay installation

The inverter has an electronic thermal relay function to protect the motor from overheating. However, when running multiple motors with one inverter or operating a multi-pole motor, provide a thermal relay (OCR) between the inverter and motor. In this case, set the electronic thermal relay function of the inverter to 0A. And for the setting of the thermal relay, add the line-to-line leakage current (*refer to page 61*) to the current value on the motor rating plate.

For low-speed operation where the cooling capability of the motor reduces, it is recommended to use a thermal protector or thermistor-incorporated motor.

### ● Secondary side measuring instrument

When the wiring length between the inverter and motor is long, select the device that has enough current rating. Otherwise the measuring instrument or CT which is used especially for the 400V class small-capacity inverter may generate heat due to the influence of line leakage current. To measure and display the output voltage and output current of the inverter, it is recommended to use the terminal AM-5 output function of the inverter.

### ● Disuse of power factor improving capacitor (power capacitor)

The power factor improving capacitor and surge suppressor on the inverter output side may be overheated or damaged by the harmonic components of the inverter output. Also, since an excessive current flows in the inverter to activate overcurrent protection, do not install a capacitor or surge suppressor. For power factor improvement, use the power factor improving DC reactor (see *page 51*).

### ● Wire thickness and wiring distance

When the wiring length between the inverter and motor is long, use thick wires so that the voltage drop of the main circuit cable is 2% or less especially at low frequency output. (A selection example for the wiring distance of 20m is shown on *page 57*)

Especially at a long wiring distance, the maximum wiring length should be within 500m since the overcurrent protection function may be misactivated by the influence of a charging current due to the stray capacitances of the wiring. (The overall wiring length for connection of multiple motors should be within the value in the table below.)

Pr. 72 PWM frequency selection setting (carrier frequency)	0.75K	1.5K	2.2K or more
2	300m	500m	500m
3 to 15	200m	300m	500m

Use the recommended connection cable when installing the operation panel away from the inverter unit or when connecting the parameter unit.

For remote operation via analog signal, wire the control cable between the operation box or operation signal and inverter within 30m and away from the power circuits (main circuit and relay sequence circuit) to prevent induction from other devices.

When using the external potentiometer instead of the parameter unit to set the frequency, use a shielded or twisted cable, and do not earth (ground) the shield, but connect it to terminal 5 as shown below.

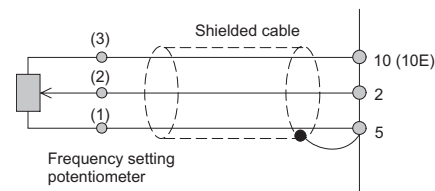
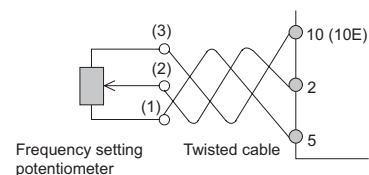

### ● Earth (Ground)

When the inverter is run in the low acoustic noise mode, more leakage currents occur than in the non-low acoustic noise mode due to high-speed switching operation. Be sure to use the inverter and motor after grounding (earthing) them. In addition, always use the earth (ground) terminal of the inverter to earth (ground) the inverter. (Do not use the case and chassis)

Features

Peripheral Devices  
Why energy savings?

Standard Specifications

Outline Dimension Drawings

Terminal Connection Diagram  
Terminal Specification Explanation

Operation Panel

Parameter List

Explanations of Parameters

Protective Functions

Options

Instructions

Motor

Compatibility

Warranty

Inquiry

**Noise**

When performing low-noise operation at higher carrier frequency, electromagnetic noise tends to increase. Therefore, refer to the following measure example and consider taking the measures. Depending on the installation condition, the inverter may be affected by noise in a non-low noise (initial) status.

- The noise level can be reduced by decreasing the carrier frequency (Pr. 72).
- As measures against AM radio broadcasting noise and sensor malfunction, turning on the built-in noise reduction filter produces an effect. (For the switching method, refer to the instruction manual.)
- As measures against induction noise from the power cable of the inverter, an effect is produced by putting a distance of 30cm (at least 10cm) or more and using a twisted pair shielded cable as a signal cable. Do not earth (ground) shield but connect it to signal common cable.

**Noise reduction examples**

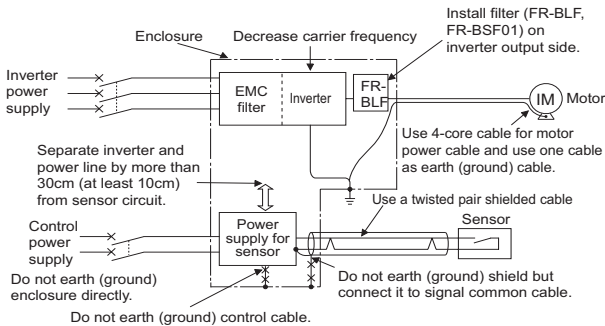

**Leakage currents**

Capacitances exist between the inverter I/O cables, other cables and earth and in the motor, through which a leakage current flows. Since its value depends on the capacitances, carrier frequency, etc., low acoustic noise operation at the increased carrier frequency of the inverter will increase the leakage current. Therefore, take the following measures. Select the earth leakage breaker according to its rated sensitivity current, independently of the carrier frequency setting.

**To-earth (ground) leakage currents**

Type	Influence and Measures
<b>Influence and measures</b>	<ul style="list-style-type: none"> <li>· Leakage currents may flow not only into the inverter's own line but also into the other lines through the earth (ground) cable, etc. These leakage currents may operate earth (ground) leakage circuit breakers and earth leakage relays unnecessarily.</li> <li>● Countermeasures</li> <li>· If the carrier frequency setting is high, decrease the Pr. 72 PWM frequency selection setting. Note that motor noise increases. Select Pr. 240 Soft-PWM operation selection to make the sound inoffensive.</li> <li>· By using earth leakage circuit breakers designed for harmonic and surge suppression in the inverter's own line and other line, operation can be performed with the carrier frequency kept high (with low noise).</li> </ul>
<b>Undesirable current path</b>	

**Line leakage current**

Type	Influence and Measures
<b>Influence and measures</b>	<ul style="list-style-type: none"> <li>· This leakage current flows via a static capacitance between the inverter output cables.</li> <li>· The external thermal relay may be operated unnecessarily by the harmonics of the leakage current. When the wiring length is long (50m or more) for the 400V class small-capacity model (7.5kW or less), the external thermal relay is likely to operate unnecessarily because the ratio of the leakage current to the rated motor current increases.</li> <li>● Countermeasures</li> <li>· Use Pr. 9 Electronic thermal O/L relay.</li> <li>· If the carrier frequency setting is high, decrease the Pr. 72 PWM frequency selection setting. Note that motor noise increases. Select Pr. 240 Soft-PWM operation selection to make the sound inoffensive. To ensure that the motor is protected against line-to-line leakage currents, it is recommended to use a temperature sensor to directly detect motor temperature.</li> </ul>
<b>Undesirable current path</b>	

● Harmonic suppression guideline

Harmonic currents flow from the inverter to a power receiving point via a power transformer. The harmonic suppression guidelines were established to protect other consumers from these outgoing harmonic currents.

The three-phase 200V input specifications 3.7kW or less are previously covered by "Harmonic suppression guideline for household appliances and general-purpose products" and other models are covered by "Harmonic suppression guideline for consumers who receive high voltage or special high voltage". However, the general-purpose inverter has been excluded from the target products covered by "Harmonic suppression guideline for household appliances and general-purpose products" in January 2004 and all capacities of all models are now target products of "Harmonic suppression guideline for consumers who receive high voltage or special high voltage".

· Harmonic suppression guideline for consumers who receive high voltage or special high voltage

This guideline sets forth the maximum values of harmonic currents outgoing from a high-voltage or especially high-voltage consumer who will install, add or renew harmonic generating equipment. If any of the maximum values is exceeded, this guideline requires that consumer to take certain suppression measures.

Users who use models other than the target models are not covered by the guideline. However, we ask to connect an AC reactor and a DC reactor as before.

For compliance to the "Harmonic suppression guideline for consumers who receive high voltage or special high voltage"

Input Power Supply	Target Capacity	Measures
Three-phase 200V	All capacities	Make a judgment based on "Harmonic suppression guideline for consumers who receive high voltage or special high voltage" issued by the Japanese Ministry of Economy, Trade and Industry (formerly Ministry of International Trade and Industry) in September 1994 and take measures if necessary. For calculation method of power supply harmonics, refer to materials below.
Three-phase 400V		Reference materials · "Harmonic suppression measures of the general-purpose inverter" Jan., 2004 Japan Electrical Manufacturer's Association · "Calculation method of harmonic current of the general-purpose inverter used by specific consumers" JEM-TR201 (Revised in December 2003) : Japan Electrical Manufacturer's Association

For compliance to "Harmonic suppression guideline of the general-purpose inverter (input current of 20A or less) for consumers other than specific consumers" published by JEMA

Input Power Supply	Target Capacity	Measures
Three-phase 200V	3.7kW or less	Connect the AC reactor or DC reactor recommended in a catalog or an instruction manual.  Reference materials · "Harmonic suppression guideline of the general-purpose inverter (input current of 20A or less)" JEM-TR226 (Revised in December 2003) : Japan Electrical Manufacturer's Association

● Calculation of outgoing harmonic current

Outgoing harmonic current = fundamental wave current (value converted from received power voltage) × operation ratio × harmonic content

- Operation ratio: Operation ratio = actual load factor × operation time ratio during 30 minutes
- Harmonic content: Found in Table.

Table 1: Harmonic content (Values of the fundamental current is 100%)

Reactor	5th	7th	11th	13th	17th	19th	23rd	25th
Not used	65	41	8.5	7.7	4.3	3.1	2.6	1.8
Used (AC side)	38	14.5	7.4	3.4	3.2	1.9	1.7	1.3
Used (DC side)	30	13	8.4	5.0	4.7	3.2	3.0	2.2
Used (AC, DC sides)	28	9.1	7.2	4.1	3.2	2.4	1.6	1.4

Table 2: Rated capacities and outgoing harmonic currents of inverter-driven motors

Applied Motor kW	Rated Current [A]		Fundamental Wave Current Converted from 6.6kV (mA)	Rated Capacity (kVA)	Fundamental Wave Current Converted from 6.6kV (No reactor, 100% operation ratio)								
	200V	400V			5th	7th	11th	13th	17th	19th	23rd	25th	
0.75	2.74	1.37	83	0.97	53.95	34.03	7.055	6.391	3.569	2.573	2.158	1.494	
1.5	5.50	2.75	167	1.95	108.6	68.47	14.20	12.86	7.181	5.177	4.342	3.006	
2.2	7.93	3.96	240	2.81	156.0	98.40	20.40	18.48	10.32	7.440	6.240	4.320	
3.7	13.0	6.50	394	4.61	256.1	161.5	33.49	30.34	16.94	12.21	10.24	7.092	
5.5	19.1	9.55	579	6.77	376.4	237.4	49.22	44.58	24.90	17.95	15.05	10.42	
7.5	25.6	12.8	776	9.07	504.4	318.2	65.96	59.75	33.37	24.06	20.18	13.97	
11	36.9	18.5	1121	13.1	728.7	459.6	95.29	86.32	48.20	34.75	29.15	20.18	
15	49.8	24.9	1509	17.6	980.9	618.7	128.3	116.2	64.89	46.78	39.24	27.16	
18.5	61.4	30.7	1860	21.8	1209	762.6	158.1	143.2	79.98	57.66	48.36	33.48	
22	73.1	36.6	2220	25.9	1443	910.2	188.7	170.9	95.46	68.82	57.72	39.96	
30	98.0	49.0	2970	34.7	1931	1218	252.5	228.7	127.7	92.07	77.22	53.46	
37	121	60.4	3660	42.8	2379	1501	311.1	281.8	157.4	113.5	95.16	65.88	
45	147	73.5	4450	52.1	2893	1825	378.3	342.7	191.4	138.0	115.7	80.10	
55	180	89.9	5450	63.7	3543	2235	463.3	419.7	234.4	169.0	141.7	98.10	

Applied Motor kW	Rated Current [A]		Fundamental Wave Current Converted from 6.6kV (mA)	Rated Capacity (kVA)	Fundamental Wave Current Converted from 6.6kV (With DC reactor, 100% operation ratio)								
	200V	400V			5th	7th	11th	13th	17th	19th	23rd	25th	
75	245	123	8200	87.2	2237	969	626	373	350	239	224	164	
90	293	147	9800	104	2673	1158	748	445	419	285	267	196	
110	357	179	11933	127	3254	1410	911	542	510	347	325	239	
132	—	216	14400	153	3927	1702	1100	655	615	419	393	288	
160	—	258	17200	183	4691	2033	1313	782	735	500	469	344	
220	—	355	23667	252	6455	2797	1807	1076	1011	688	645	473	
250	—	403	26867	286	7327	3175	2052	1221	1148	782	733	537	
280	—	450	27273	319	8182	3545	2291	1364	1282	873	818	600	
315	—	506	30667	359	9200	3987	2576	1533	1441	981	920	675	
355	—	571	34606	405	10382	4499	2907	1730	1627	1107	1038	761	
400	—	643	38970	456	11691	5066	3274	1949	1832	1247	1169	857	
450	—	723	43818	512	13146	5696	3681	2191	2060	1402	1315	964	
500	—	804	48727	570	14618	6335	4093	2436	2290	1559	1462	1072	
560	—	900	54545	638	16364	7091	4582	2727	2564	1746	1636	1200	

Features  
 Peripheral Devices  
 Why energy savings?  
 Standard Specifications  
 Outline Dimension Drawings  
 Terminal Connection Diagram  
 Terminal Specification Explanation  
 Operation Panel  
 Parameter List  
 Explanations of Parameters  
 Protective Functions  
 Options  
 Instructions  
 Motor  
 Compatibility  
 Warranty  
 Inquiry

# Application to Motor

## Application to standard motor

When the Mitsubishi standard squirrel-cage motor (SF-JR, 4-pole) and inverter of the same capacity are used, the torque characteristics are as shown below.

### ● Output characteristics

#### 60Hz torque reference

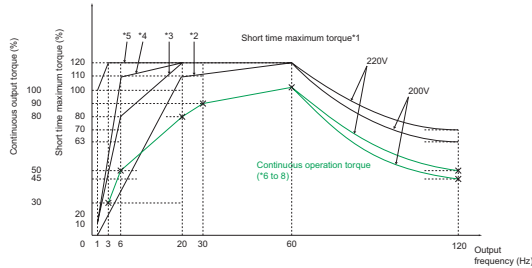

#### 50Hz torque reference

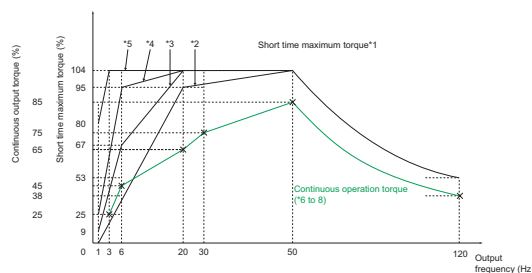

- \*1 The 60Hz torque reference indicates that the rated torque of the motor running at 60Hz is 100%, and the 50Hz torque reference indicates that the rated torque of the motor running at 50Hz is 100%
- \*2 Torque boost minimum (0%)
- \*3 Torque boost standard (initial value)
- \*4 Torque boost large (0.75K... 10%, 1.5K to 3.7K... 7%, 5.5K, 7.5K... 6%, 11K or more... 4%)
- \*5 Enabled for torque boost adjustment (3.7kW or less) or simple magnetic flux vector control (slip compensation setting)
- \*6 A general-purpose, squirrel-cage motor must be used at lower continuous operating torque in rated operation as shown in the chart since the cooling capability of the fan installed on the rotor reduces at a lower speed. (Instantaneous torque occurs)
- \*7 200/220V 60Hz or 200V 50Hz in the chart indicates a motor torque standard (base frequency set in Pr. 3 of the inverter) and is not the frequency of the power supply. You can also set 60Hz in a 50Hz power supply area.
- \*8 As shown in the chart, the 60Hz torque reference setting allows you to use the motor more efficiently as it can bring out the 100% torque of the motor continuously.
- \*9 This chart shows the characteristic available when a constant-torque load is selected for load pattern selection (Pr. 14).

### ● Motor loss and temperature rise

The motor operated by the inverter has a limit on the continuous operating torque since it is slightly higher in temperature rise than the one operated by a commercial power supply. At a low speed, reduce the output torque of the motor since the cooling effect decreases. When 100% torque is needed continuously at low speed, consider using a constant-torque motor.

### ● Torque characteristic

The motor operated by the inverter may be less in motor torque (especially starting torque) than the one driven by the commercial power supply. It is necessary to fully check the load torque characteristic of the machine.

### ● Vibration

The machine-installed motor operated by the inverter may be slightly greater in vibration than the one driven by the commercial power supply. The possible causes of vibration are as follows.

1. Vibration due to imbalance of the rotor itself including the machine
2. Resonance due to the natural oscillation of the mechanical system. Caution is required especially when the machine used at constant speed is operated at variable speed. The frequency jump function allows

resonance points to be avoided during operation. (During acceleration/deceleration, the frequency within the setting range is passed through.) An effect is also produced if the PWM carrier frequency in Pr. 72 is changed. When a two-pole motor is operated at higher than 60Hz, caution should be taken since such operation may cause abnormal vibration.

## Inverter-driven 400V class motor

When driving a 400V class motor by the inverter, surge voltages attributable to the wiring constants may occur at the motor terminals, deteriorating the insulation of the motor. In such a case, consider taking the following measures.

- (1) Rectifying the motor insulation
  1. Use a "400V class inverter driven insulation-enhanced motor".  
Note: The four poles of the Mitsubishi standard motor (SF-JR, SB-JR) have the 400V class inverter driving insulation-enhanced feature.
  2. For the dedicated motor such as the constant-torque motor and low-vibration motor, use the "inverter-driven, dedicated motor".
- (2) Suppressing the surge voltage on the inverter side  
Connect a filter on the secondary side of the inverter to suppress a surge voltage so that the terminal voltage of the motor is 850V or less. When driving by the Mitsubishi inverter, connect an optional surge voltage suppression filter (FR-ASF-H) for the 55K or less and an optional sine wave filter (MT-BSL, BSC) for the 75K or more on the inverter output side.

## Application to constant-torque motor

Since a constant-torque motor is greater in current than the standard motor, the inverter capacity may be one rank higher. For a constant-torque motor, decrease the torque boost setting. Recommended value 0.75kW... 6%, 1.5 to 3.7kW... 4%, 5.5 to 7.5kW...3%, 11 to 37kW...2%, 45 to 55kW...1.5%, 75k or more...1%

When two or more motors are operated synchronously, torque imbalance is likely to occur as motor slip is smaller than that of the standard motor.

## Application to special motors

### ● Pole changing motor

As this motor differs in rated current from the standard motor, confirm the maximum current of the motor and select the inverter. Be sure to change the number of poles after the motor has stopped. If the number of poles is changed during rotation, the regenerative overvoltage protection circuit may be activated to cause an inverter alarm, coasting the motor to a stop.

### ● Geared motor

The continuous operating rotation range of this motor changes depending on the lubrication system and maker. Especially in the case of oil lubrication, continuous operation in the low speed range only can cause gear seizure. For fast operation at higher than 60Hz, please consult the maker.

### ● Synchronous motor

This motor is not suitable for applications of large load variation or impact, where out-of-sync is likely to occur. Please contact us when using this motor because its starting current and rated current are greater than those of the standard motor and will not rotate stably at low speed.

# Main Differences and Compatibilities with the FR-F500(L) Series

Item	FR-F500 (L)	FR-F700
Changed/cleared functions	Simple mode parameters 61	Simple mode parameters 15
	Pr. 0 Torque boost initial value 11K to 55K: 2%	Pr. 0 Torque boost initial value 11K to 37K: 2%, 45K, 55K: 1.5% (When the torque boost value of the FR-F500 series used was the initial value, it is not necessary to change the torque boost value from the initial value when replacing with the FR-F700 series.)
	User group 1 (16), user group 2 (16) (Pr. 160, Pr. 173 to Pr. 175)	User group (16) only Setting methods were partially changed (Pr. 160, Pr. 172 to Pr. 173)
	User initial value setting (Pr. 199)	"User initial value setting" (Pr. 199) was cleared Substitutable with the copy function of the operation panel (FR-DU07)
	DC injection brake function with terminal (X13 signal) (Pr. 11 setting value 8888, Pr. 180 to Pr. 186 setting value 13)	DC injection brake function with terminal was cleared Start in reverse rotation is possible with flying start function (frequency search of automatic restart after instantaneous power failure function)
	Long wiring mode (Pr. 240 setting 10, 11)	Setting is not necessary (Pr. 240 settings "10" and "11" were cleared)
	Intelligent optimum acceleration/deceleration (Pr. 60 setting "3" and Pr. 61 to Pr. 63)	Function was cleared For deceleration time, overvoltage alarm can be avoided with regeneration avoidance function (Pr. 882 to Pr. 885).
	Automatic torque boost (Pr. 38, Pr. 39)	Automatic torque boost was cleared because of addition of "Simple magnetic flux vector" (Pr. 80)
Terminal block	Removable terminal block Priority compatibility (Terminal block of the F500 can be mounted)	
PU	FR-PU04, DU04 FR-DU07 FR-DU04 unavailable (Partly restricted when the FR-PU04 is used.)	
Plug-in option	Dedicated plug-in option (not compatible)	
	Computer link, relay output option FR-A5NR	Built into the inverter (RS-485 terminals, relay output 2 points)
	Three boards can be mounted	One board can be mounted
Installation size	FR-F720-0.75K, 2.2K, 3.7K, 7.5K, 18.5K, 22K, 37K, 45K, FR-F740-0.75K to 3.7K, 7.5K, 22K, 37K to 55K are compatible in mounting dimensions For other capacities, an optional intercompatibility attachment (FR-AAT) is necessary.	

Features

Peripheral Devices  
Why energy savings?

Standard Specifications

Outline Dimension Drawings

Terminal Connection Diagram  
Terminal Specification Explanation

Operation Panel

Parameter List

Explanations of Parameters

Protective Functions

Options

Instructions

Motor

Compatibility

Warranty

Inquiry

## Warranty

### 1. Gratis warranty period and coverage

#### [Gratis warranty period]

Note that an installation period of less than one year after installation in your company or your customer's premises or a period of less than 18 months (counted from the date of production) after shipment from our company, whichever is shorter, is selected.

#### [Coverage]

##### (1) Diagnosis of failure

As a general rule, diagnosis of failure is done on site by the customer.

However, Mitsubishi or Mitsubishi service network can perform this service for an agreed upon fee upon the customer's request.

There will be no charges if the cause of the breakdown is found to be the fault of Mitsubishi.

##### (2) Breakdown repairs

There will be a charge for breakdown repairs, exchange replacements and on site visits for the following four conditions, otherwise there will be a charge.

- 1) Breakdowns due to improper storage, handling, careless accident, software or hardware design by the customer.
- 2) Breakdowns due to modifications of the product without the consent of the manufacturer.
- 3) Breakdowns resulting from using the product outside the specified specifications of the product.
- 4) Breakdowns that are outside the terms of warranty.

Since the above services are limited to Japan, diagnosis of failures, etc. are not performed abroad.

If you desire the after service abroad, please register with Mitsubishi. For details, consult us in advance.

### 2. Exclusion of chance loss from warranty liability

Regardless of the gratis warranty term, compensation to chance losses incurred to your company or your customers by failures of Mitsubishi products and compensation for damages to products other than Mitsubishi products and other services are not covered under warranty.

### 3. Repair period after production is discontinued

Mitsubishi shall accept product repairs for seven years after production of the product is discontinued.

### 4. Terms of delivery

In regard to the standard product, Mitsubishi shall deliver the standard product without application settings or adjustments to the customer and Mitsubishi is not liable for on site adjustment or test run of the product.



## International FA center

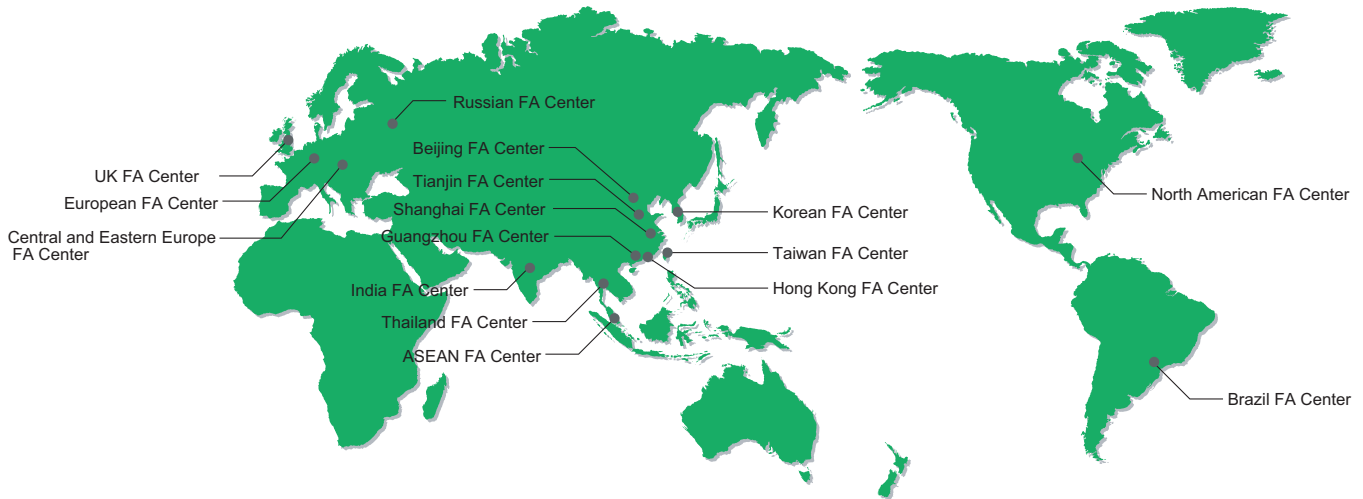

- **North American FA Center**  
 MITSUBISHI ELECTRIC AUTOMATION, INC.  
 500 Corporate Woods Parkway, Vernon Hills, IL60061 U.S.A  
 TEL. +1-847-478-2100 FAX. +1-847-478-0327
- **Korean FA Center**  
 MITSUBISHI ELECTRIC AUTOMATION KOREA CO., LTD.  
 B1F,2F, 1480-6, Gayang-Dong, Gangseo-Gu, Seoul, 157-200, Korea  
 TEL. +82-2-3660-9607 FAX. +82-2-3664-0475
- **Taiwan FA Center**  
 SETSUYO ENTERPRISE CO., LTD.  
 6F No.105, Wu Kung 3rd RD, Wu-Ku Hsiang Taipei Hsien, 248, Taiwan  
 TEL. +886-2-2299-2499 FAX. +886-2-2299-2509
- **Beijing FA Center**  
 MITSUBISHI ELECTRIC AUTOMATION (SHANGHAI) LTD. BEIJING OFFICE  
 9F Office Tower 1, Henderson Center, 18 Jianguomennei Avenue, Dongcheng District, Beijing, China 100005  
 TEL. +86-10-6518-8830 FAX. +86-10-6518-8030
- **Russian FA Center**  
 MITSUBISHI ELECTRIC EUROPE B.V.  
 -Representative Office in St. Petersburg  
 Sverdlovskaya Emb.,44, Bld Sch, BC "Benua";195027, St.Petersburg, Russia  
 TEL. +7-812-633-3496 FAX. +7-812-633-3499
- **Tianjin FA Center**  
 MITSUBISHI ELECTRIC AUTOMATION (SHANGHAI) LTD. TIANJIN OFFICE  
 B-2 801/802, Youyi Building, No.50 Youyi Road, Hexi District, Tianjin, China 300061  
 TEL +86-22-2813-1015 FAX. +86-22-2813-1017
- **Shanghai FA Center**  
 MITSUBISHI ELECTRIC AUTOMATION (SHANGHAI) LTD.  
 4/F Zhi Fu Plazz, No.80 Xin Chang Road, Shanghai, China 200003  
 TEL. +86-21-6121-2460 FAX. +86-21-6121-2424
- **Guangzhou FA Center**  
 MITSUBISHI ELECTRIC AUTOMATION (SHANGHAI) LTD. GUANGZHOU OFFICE  
 Rm.1609, North Tower, The Hub Center, No.1068, Xing Gang East Road, Haizhu District, Guangzhou, China 510335  
 TEL. +86-20-8923-6713 FAX. +86-20-8923-6715
- **Hong Kong FA Center**  
 MITSUBISHI ELECTRIC AUTOMATION (Hong Kong) LTD.  
 10th Floor, Manulife Tower, 169 Electric Road, North Point, Hong Kong  
 TEL.+852-2887-8870 FAX. +852-2887-7984
- **India FA Center**  
 Mitsubishi Electric Asia Pvt. Ltd. Gurgaon Branch  
 2nd Floor, DLF Building No.9B, DLF Cyber City Phase III, Gurgaon 122002, Haryana, India  
 TEL. +91-124-4630300 FAX. +91-124-4630399
- **Thailand FA Center**  
 MITSUBISHI ELECTRIC AUTOMATION (THAILAND) CO., LTD.  
 Bang-Chan Industrial Estate No.111, Soi Serithai 54, T.Kannayao, A.Kannayao, Bangkok 10230  
 TEL. +66-2-906-3238 FAX. +66-2-906-3239
- **ASEAN FA Center**  
 MITSUBISHI ELECTRIC ASIA PTE, LTD.  
 307 Alexandra Road #05-01/02, Mitsubishi Electric Building, Singapore 159943  
 TEL. +65-6470-2480 FAX. +65-6476-7439
- **European FA Center**  
 MITSUBISHI ELECTRIC EUROPE B. V. GERMAN BRANCH  
 Gothaer Strasse 8, D-40880 Ratingen, Germany  
 TEL. +49-2102-486-0 FAX. +49-2102-486-1120
- **UK FA Center**  
 MITSUBISHI ELECTRIC EUROPE B. V. UK BRANCH  
 Travellers Lane, Hatfield, Hertfordshire, AL10 8XB, UK.  
 TEL. +44-1707-276100 FAX. +44-1707-278695
- **Central and Eastern Europe FA Center**  
 MITSUBISHI ELECTRIC EUROPE B.V. CZECH BRANCH  
 Avenir Business Park, Radlicka 714/113a,158 00 Praha 5, Czech Republic  
 TEL. +420-251-551-470 FAX. +420-251-551-471
- **Brazil FA Center**  
 MELCO-TEC Representacao Comercial e Assessoria Tecnica Ltda.  
 Av. Paulista 1439, conj.74, Bela Vista CEP: 01311-200 Sao Paulo-SP-Brazil  
 TEL. +55-11-3146-2202 FAX. +55-11-3146-2217

- Features
- Peripheral Devices  
Why energy savings?
- Standard Specifications
- Outline Dimension Drawings
- Terminal Connection Diagram  
Terminal Specification Explanation
- Operation Panel
- Parameter List
- Explanations of Parameters
- Protective Functions
- Options
- Instructions
- Motor
- Compatibility

Warranty

Inquiry

 **Safety Warning**

To ensure proper use of the products listed in this catalog,  
please be sure to read the instruction manual prior to use.