







Cupola Data
 Overall Height = 11'-2"
 Base Width = 5'
 Unit Weight = 575 lbs.

Available Standard Panels

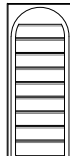
601	104	108	501
			
Decorative	Sq. Louver	Round Top Louver	Scallop

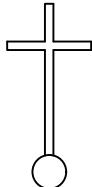
Optional Cupola Finials

	
36" Cross 8"Ø Sphere	36" Aluminum Spire 8"Ø Sphere
Weathervane selection at : www.whitehallproducts.com	

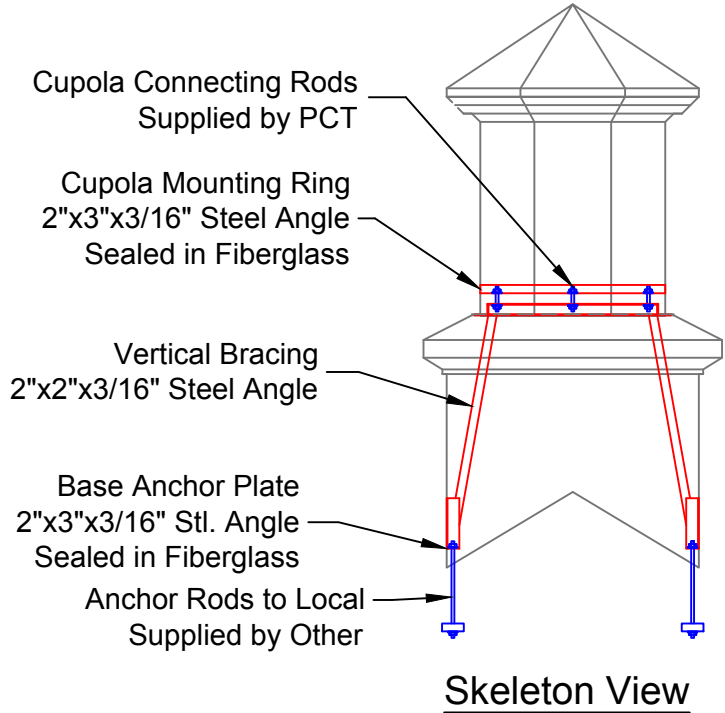
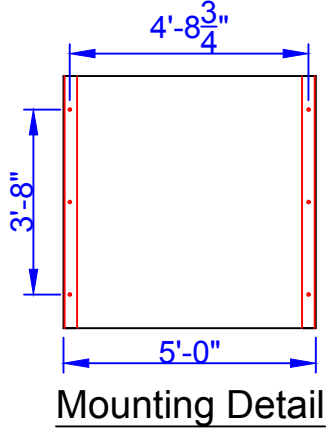
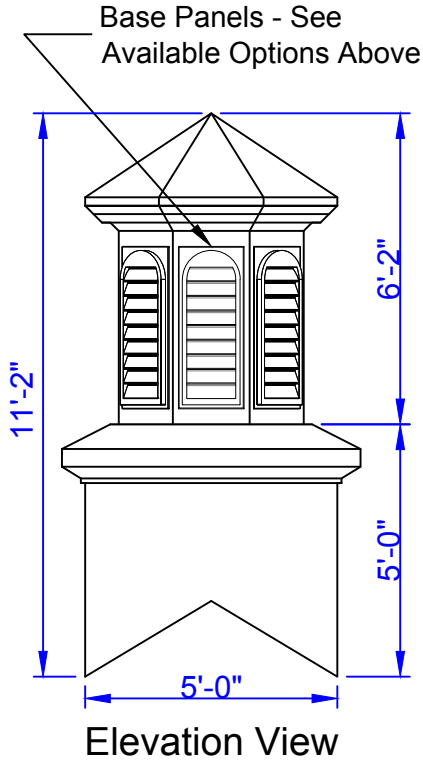

PIEDMONT
 COMPOSITES & TOOLING

33 Lewittes Rd.
 Taylorsville, NC 28681
 Phone: 828-632-8883
 Fax: 828-632-5585
 www.piedmontcomposites.com

Model :

CUPOLA

850LPK

Scale:
 N/A
 Drawn by:
 C.BOTHOS
 Created On
 -
 Updated On
 03/27/19

Note: All drawings are the property of Piedmont Composites & Tooling, LLC. Variation in material thickness, dimension and weight may occur. PCT reserves the right to change or modify design at anytime without notice.