



COLOR CLASSIC & ZONE 3 SHOW



PATTERN BOOK

April 14-16, 2023

JUDGES

FRIDAY COLOR CLASSIC JUDGES

- Sherry Haynes
- Jeannie Young

SATURDAY JUDGES (Halter/SMS/LL):

- Sherry Haynes
- Jeannie Young
- April Devitt
- Gayle Lampinen
- Christina Baldwin
- Debbie Kail

SATURDAY (Performance)/SUNDAY JUDGES

- April Devitt
- Gayle Lampinen
- Christina Baldwin
- Debbie Kail

Lancaster
EVENT CENTER
fairgrounds

Trail

Show: Color Classic And Zone 3 Show

Date: Apr 14, 2023

Age Divisions

- 116. Leadline Non-APHA Exh 3-8
- 117. All Breed WT And Yearling 1
- 119. Amateur Yearling In-hand
- 120. Yearling In-hand
- 121. SPB Yearling In-hand
- 122. Youth W-T 5-10
- 123. Amateur W-T

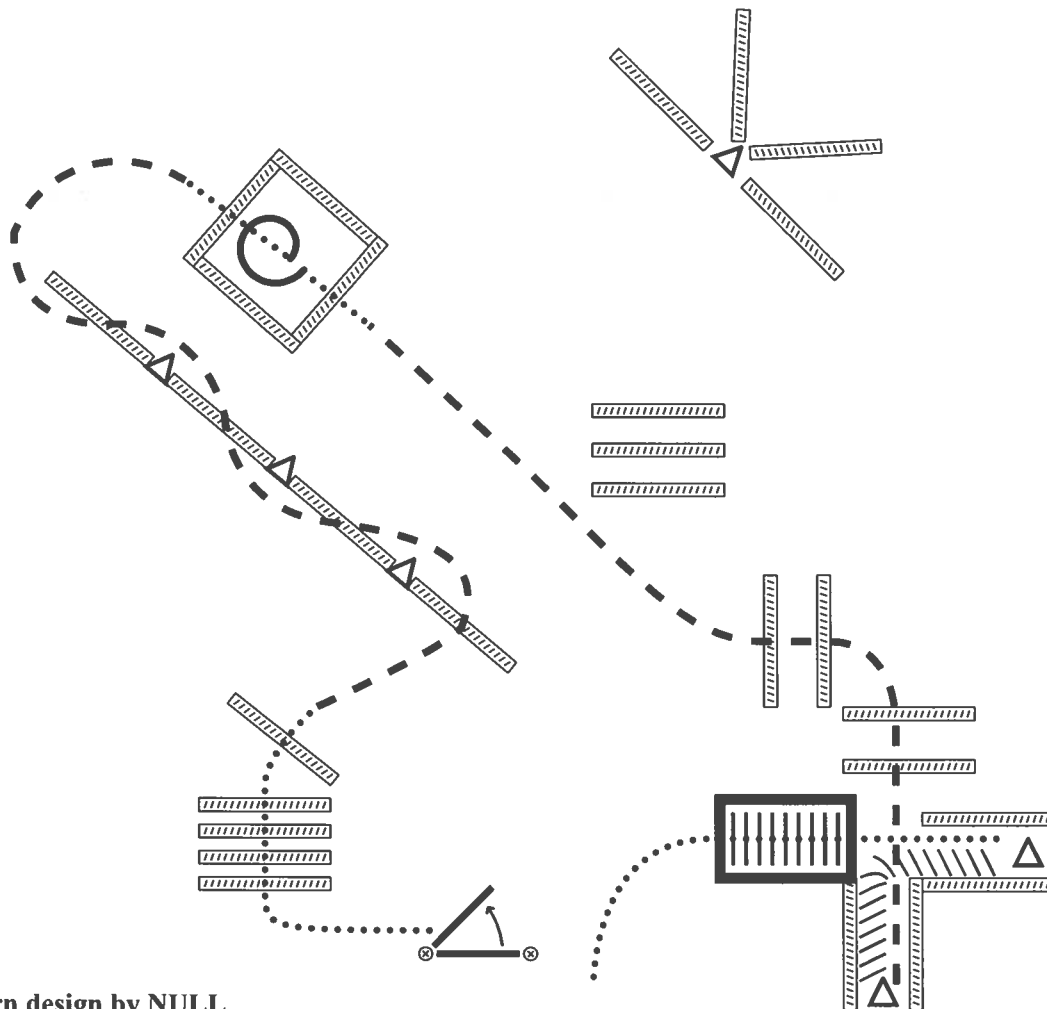

Pattern design by NULL

1. Work left hand gate
2. Walk over poles
3. Jog through serpentine
4. Walk into box, 360° either direction and walk out
5. Jog over poles
6. Jog into L and back through
7. Walk out of L and over bridge

Generated from Equiscribe for iOS
Scan the code to see your results as they are posted



Trail

Show: Color Classic And Zone 3 Show
Date: Apr 14, 2023

Age Divisions

- 118. All Breed
- 124. Novice Youth
- 125. Youth
- 126. SPB Youth
- 127. Green
- 128. Novice Amateur
- 129. Amateur
- 130. Masters Amateur
- 131. Open Trail
- 132. SPB Amateur
- 133. SPB Open

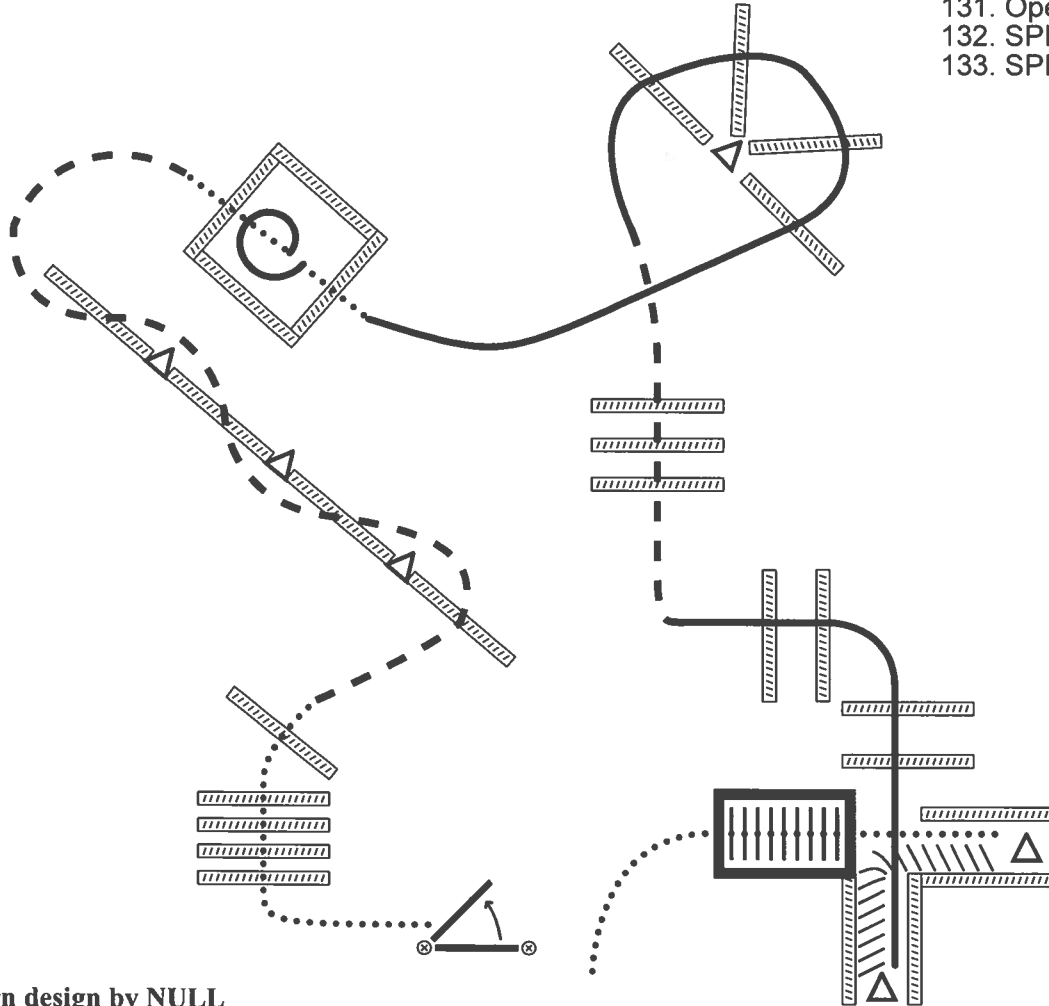

Pattern design by NULL

1. Work left hand gate
2. Walk over poles
3. Jog through serpentine
4. Walk into box, 360° either direction and walk out
5. Lope left lead over poles
6. Jog over poles
7. Right lead lope over poles
8. Lope into L and back through
9. Walk out of L and over bridge

Generated from Equiscribe for iOS
Scan the code to see your results as they are posted



Ranch Trail

Show: Color Classic And Zone 3 Show

Date: Apr 14, 2023

Age Divisions

- 134. All Breed Ranch
- 135. Youth Ranch
- 136. SPB Youth Ranch
- 137. Amateur Ranch
- 138. SPB Amateur Ranch
- 139. Open Ranch
- 140. SPB Open Ranch

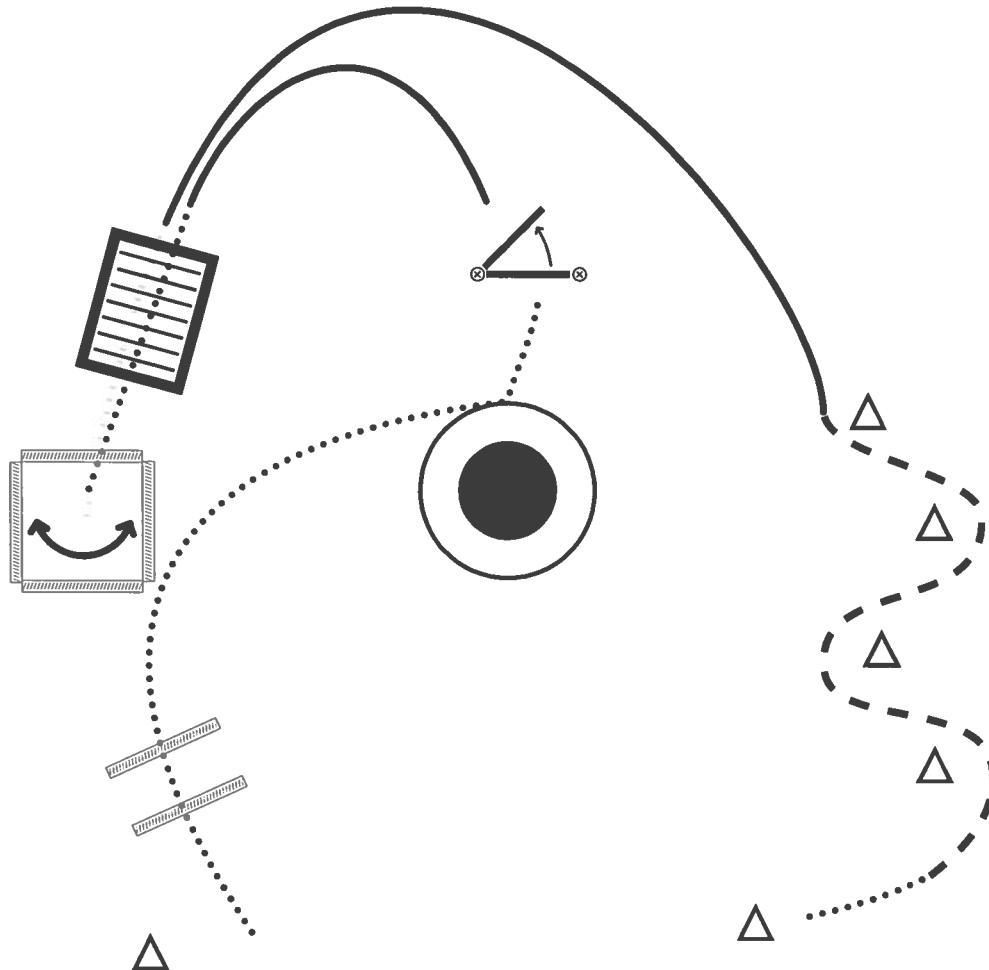

Pattern design by NULL

1. Trot over logs
2. Drag around barrel
3. Walk to and work gate
4. Lope left lead to bridge
5. Walk over bridge and into box
6. 180 either direction, walk over bridge, lope right lead to cones
7. Trot through cones
8. Walk to cone, dismount and ground tie -- exit

Generated from Equiscribe for iOS
Scan the code to see your results as they are posted



Ranch Pleasure

Show: Color Classic And Zone 3 Show

Date: Apr 14, 2023

Age Divisions

- 141. All Breed
- 142. Youth
- 143. SPB Youth
- 144. Amateur
- 145. SPB Amateur
- 146. Open
- 147. SPB Open

All distances are
approximated and are
only recommendations

Pattern may be set
clockwise or
counterclockwise

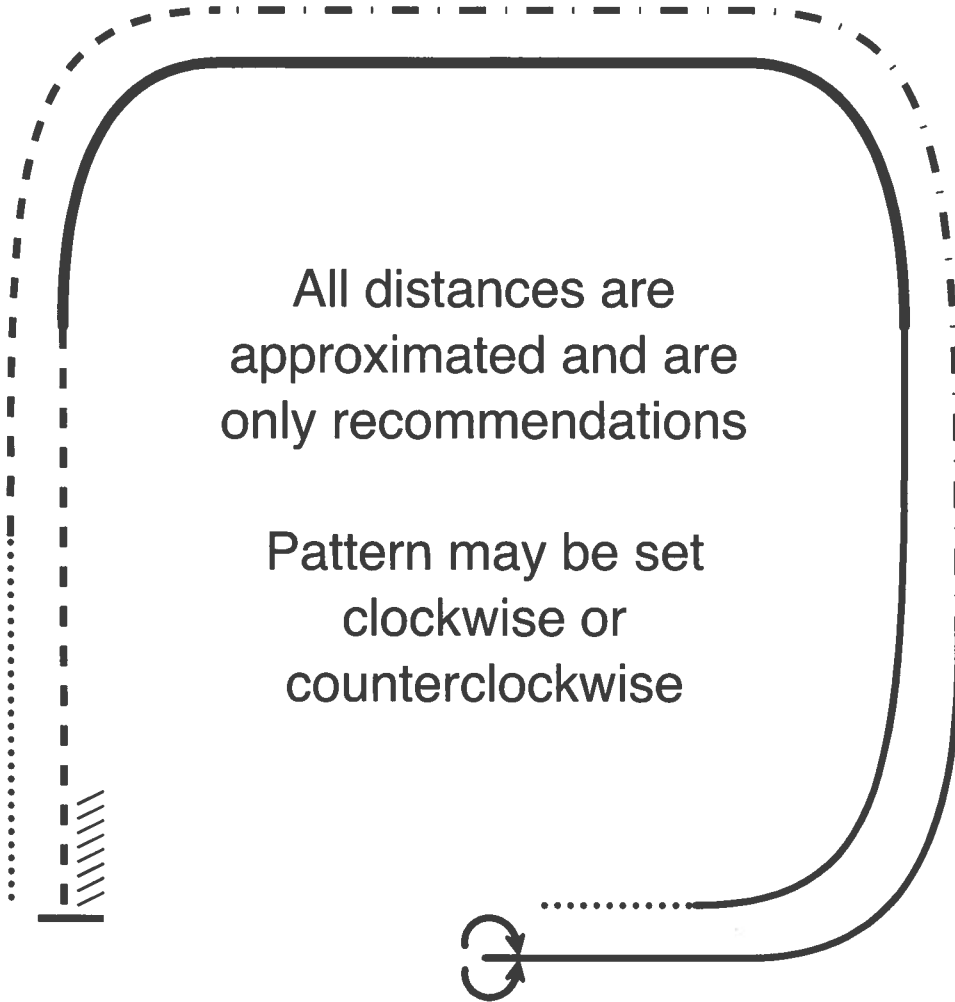

1. Extended walk
2. Trot
3. Extended trot
4. Lope
5. Stop; Reverse
6. Walk
7. Lope
8. Extended lope
9. Trot
10. Stop and back

Generated from Equiscribe for iOS
Scan the code to see your results as they are posted



English Equitation

Show: Color Classic And Zone 3 Show

Date: Apr 14, 2023

Age Divisions

92. Youth W-T

108. Amateur W-T

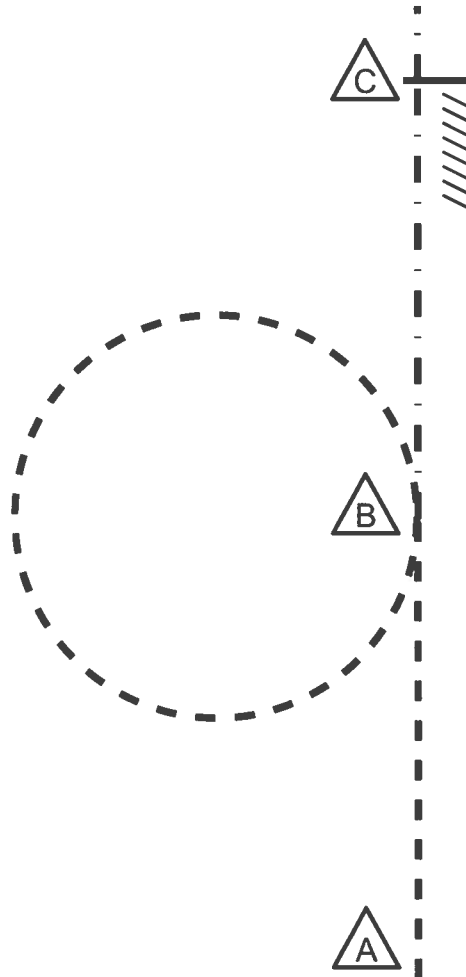

1. Posting trot on the left diagonal from A to B,
2. At B posting trot a circle to the left on the right diagonal
3. Sitting trot to C
4. Stop at C and back approximately one horse length
5. Exit at a sitting trot

Generated from Equiscribe for iOS
Scan the code to see your results as they are posted



English Equitation

Show: Color Classic And Zone 3 Show

Date: Apr 14, 2023

Age Divisions

- 104. All Breed
- 105. Novice Youth
- 106. Youth 13/U
- 107. Youth 18/U
- 109. Novice Amateur
- 110. Amateur
- 111. Masters Amateur
- 112. SPB Amateur

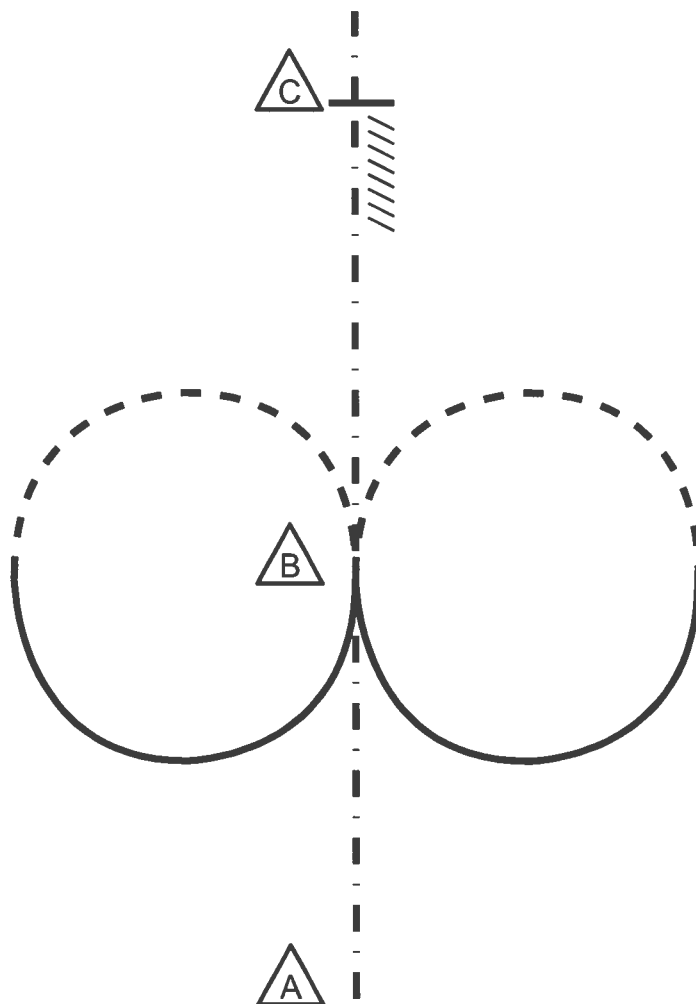

1. Sitting trot A to B
2. At B posting trot on the left diagonal in a half circle
3. Canter on the right lead back to B
4. Posting trot on the right diagonal in a half circle
5. Canter on the left lead back to B
6. Sitting trot to C
7. Stop at C and back approximately one horse length
8. Exit at a sitting trot

Generated from Equiscribe for iOS
Scan the code to see your results as they are posted



Horsemanship

Age Divisions

152. Youth W-T 5-10
171. Amateur W-T

Show: Color Classic And Zone 3 Show

Date: Apr 14, 2023

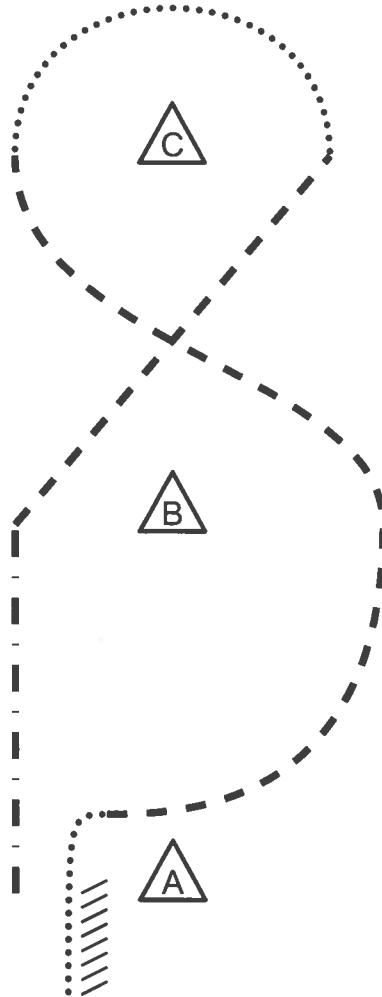

Pattern design by NULL

Be ready at A

1. Back one horse length as shown
2. Walk to A
3. Jog around B and to C
4. Walk around C
5. Jog to B
6. Extended jog from B to exit

Pattern is over once you have passed A

Generated from Equiscribe for iOS
Scan the code to see your results as they are posted



Horsemanship

Show: Color Classic And Zone 3 Show

Date: Apr 14, 2023

Age Divisions

- 166. All Breed
- 167. Novice Youth
- 168. Youth 13/U
- 169. Youth 18/U
- 170. SPB Youth 18/U
- 172. Novice Amateur
- 173. Amateur
- 174. Master Amateur
- 175. SPB Amateur

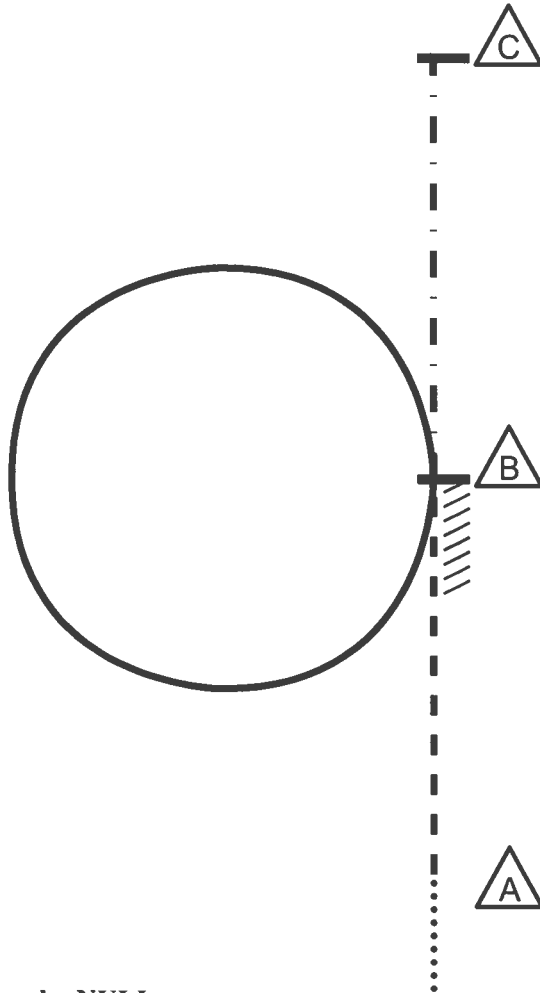

Pattern design by NULL

1. Walk to A
2. Jog from A to B
3. Lope a circle to the left on the left lead
4. Stop at B
5. Back one horse length at B
6. Extended the jog to C
7. Stop at C

Generated from Equiscribe for iOS
Scan the code to see your results as they are posted



Western Riding

Show: Color Classic And Zone 3 Show

Date: Apr 14, 2023

Age Divisions

177. Youth 18/U
179. Novice Amateur
180. Amateur
181. Open
176. Novice Youth

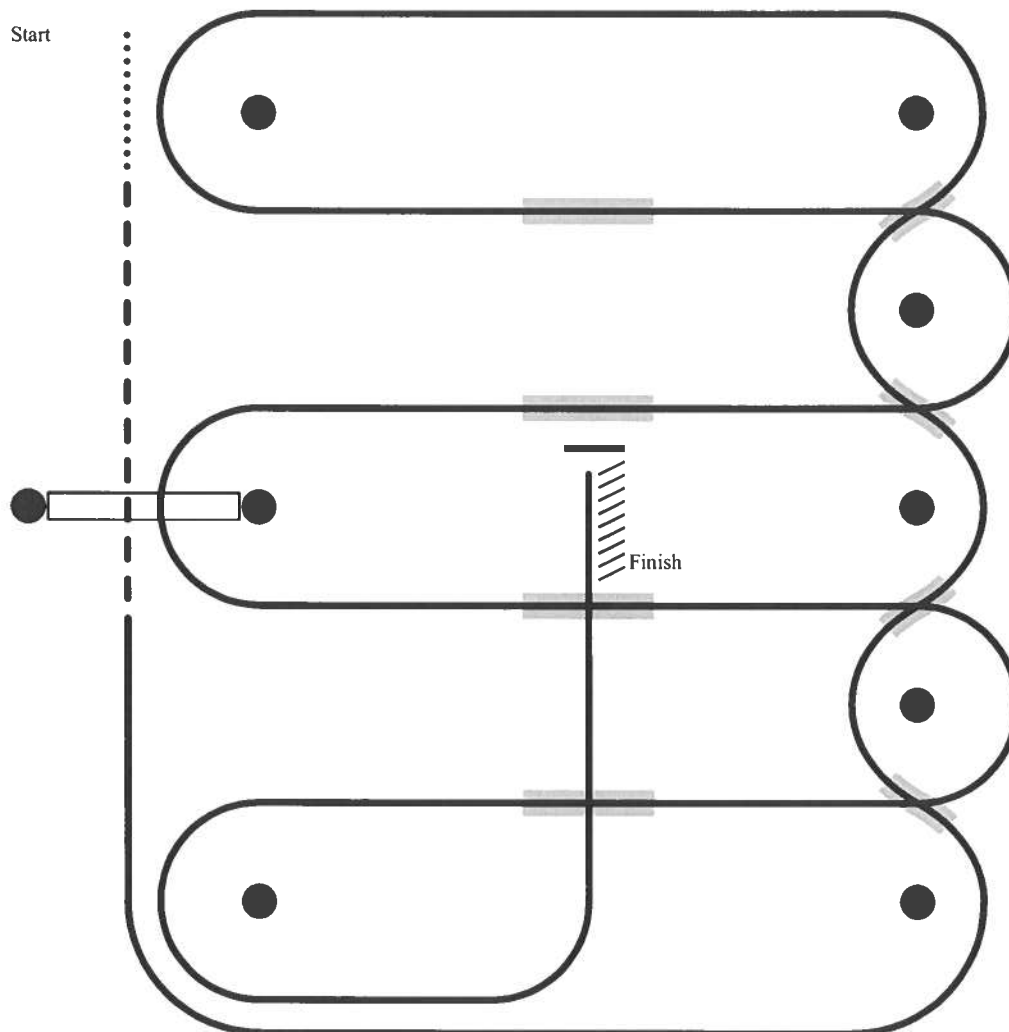

1. Walk at least 15' & jog over log
2. Transition to left lead & lope around end
3. First line change
4. Second line change
5. Third line change
6. Fourth line change lope around the end of arena
7. First crossing change
8. Second crossing change
9. Lope over log
10. Third crossing change
11. Fourth crossing change
12. Lope up the center, stop & back

Generated from Equiscribe for iOS
Scan the code to see your results as they are posted



Western Riding

Age Division

178. Green

Show: Color Classic And Zone 3 Show

Date: Apr 14, 2023

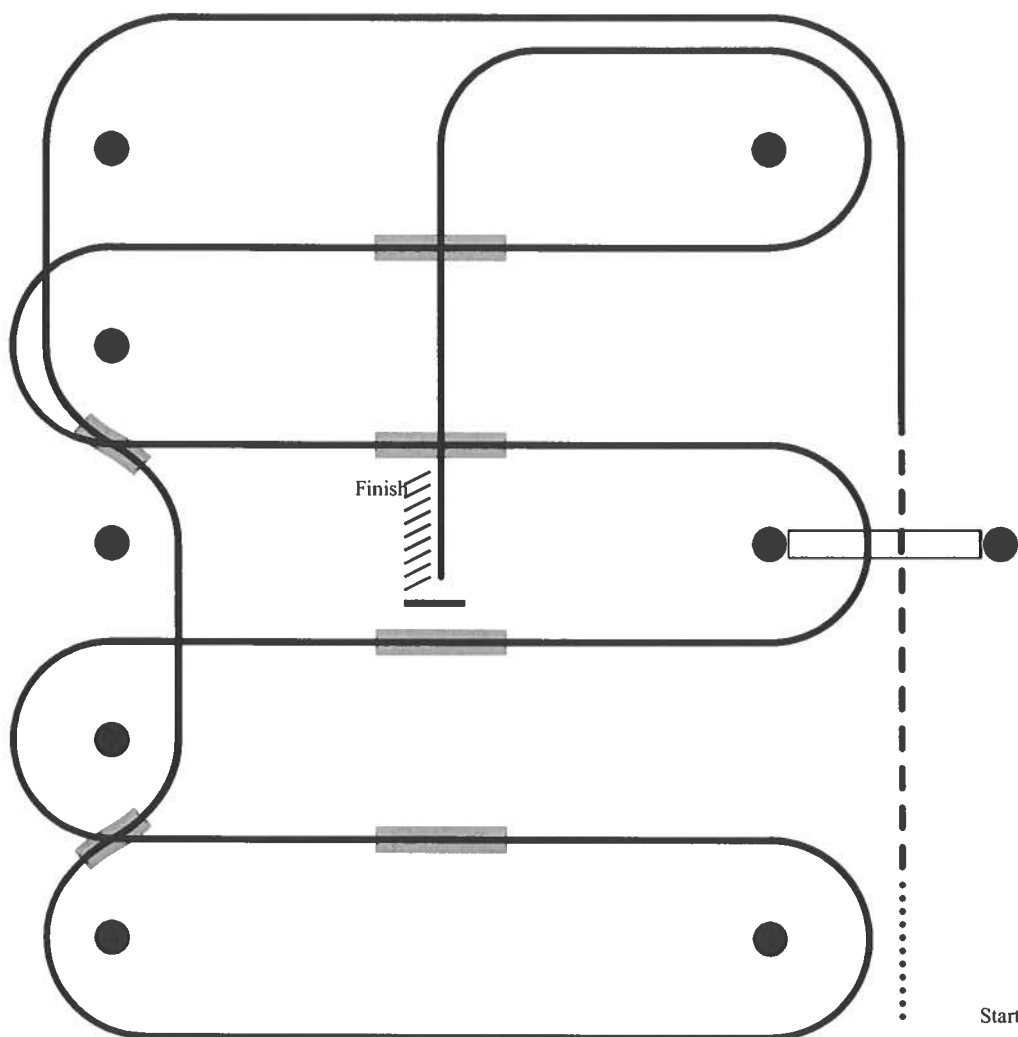

1. Walk at least 15' & jog over log
2. Transition to left lead & lope around end
3. First line change
4. Second line change lope around end of arena
5. First crossing change
6. Second crossing change
7. Lope over log
8. Third crossing change
9. Fourth crossing change
10. Lope up the center, stop & back

Generated from Equiscribe for iOS
Scan the code to see your results as they are posted



Ranch Riding

Show: Color Classic And Zone 3 Show

Date: Apr 14, 2023

Age Divisions

- 189. All Breed
- 190. Novice Youth
- 191. Youth
- 192. SPB Youth
- 193. Novice Amateur
- 194. Amateur
- 195. SPB Amateur
- 196. Open
- 197. SPB Open

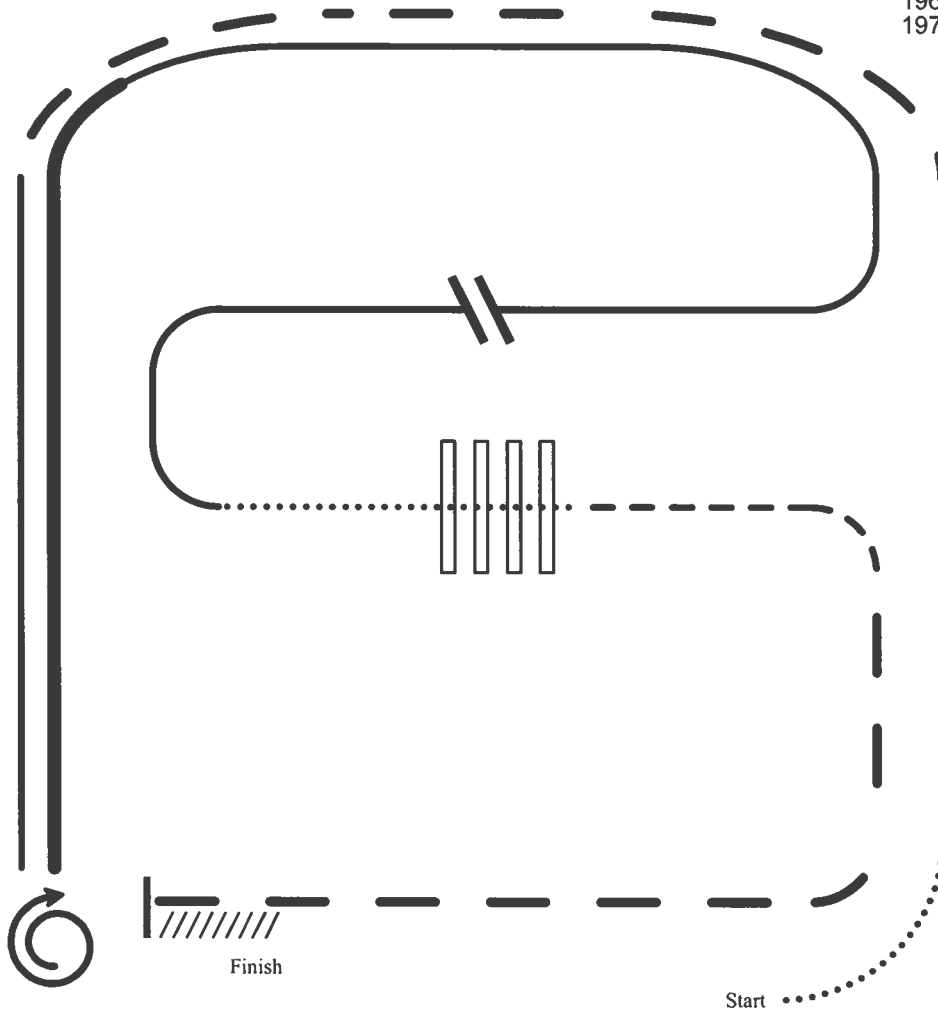

1. Walk
2. Trot
3. Extend the trot
4. Lope left lead
5. Stop, 540° turn right
6. Extended lope
7. Collect to working right lead lope
8. Change leads (simple or flying)
9. Walk, walk over logs
10. Trot
11. Extended trot
12. Stop and back

Generated from Equiscribe for iOS
Scan the code to see your results as they are posted



Ranch Reining

Show: Color Classic And Zone 3 Show

Date: Apr 14, 2023

Age Divisions

198. Youth Ranch

199. Amateur Ranch

200. Open Ranch

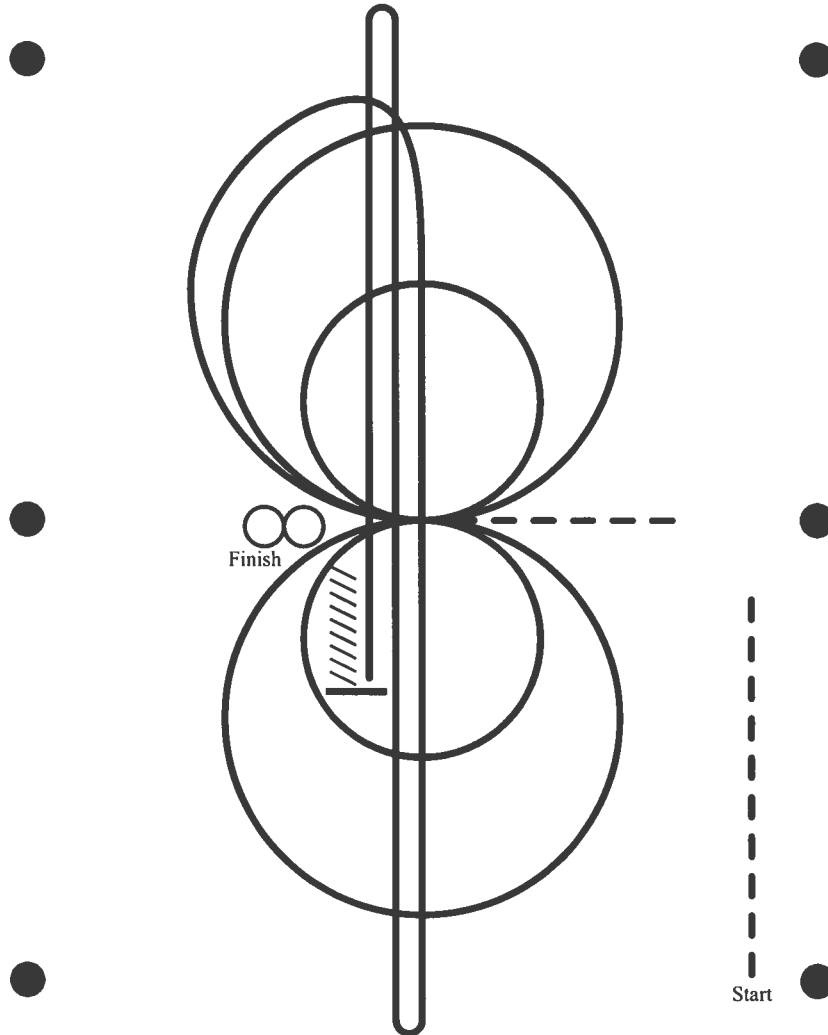

Trot to center of arena. Stop. Start pattern facing judge.

1. Beginning on the right lead complete two circles to the right, the first small and slow, the second large and fast
2. Complete two circles to the left, the first small and slow, the second large and fast. Change leads at the center
3. Begin a large circle to the right but do not close it. Run down the center of the arena past the end marker and
4. Run up the middle to the other end of the arena past the end marker and do a left roll back, no hesitation.
5. Run past the center marker. Stop, back 10 feet
6. Complete 1 spin right, then one spin left. Hesitate to complete pattern

Generated from Equiscribe for iOS
Scan the code to see your results as they are posted



Reining

Show: Color Classic And Zone 3 Show

Date: Apr 14, 2023

Age Divisions

- 201. All Breed
- 202. Youth 18/U
- 203. SPB Youth 18/U
- 204. Amateur
- 205. SPB Amateur
- 206. Open
- 207. SPB Open

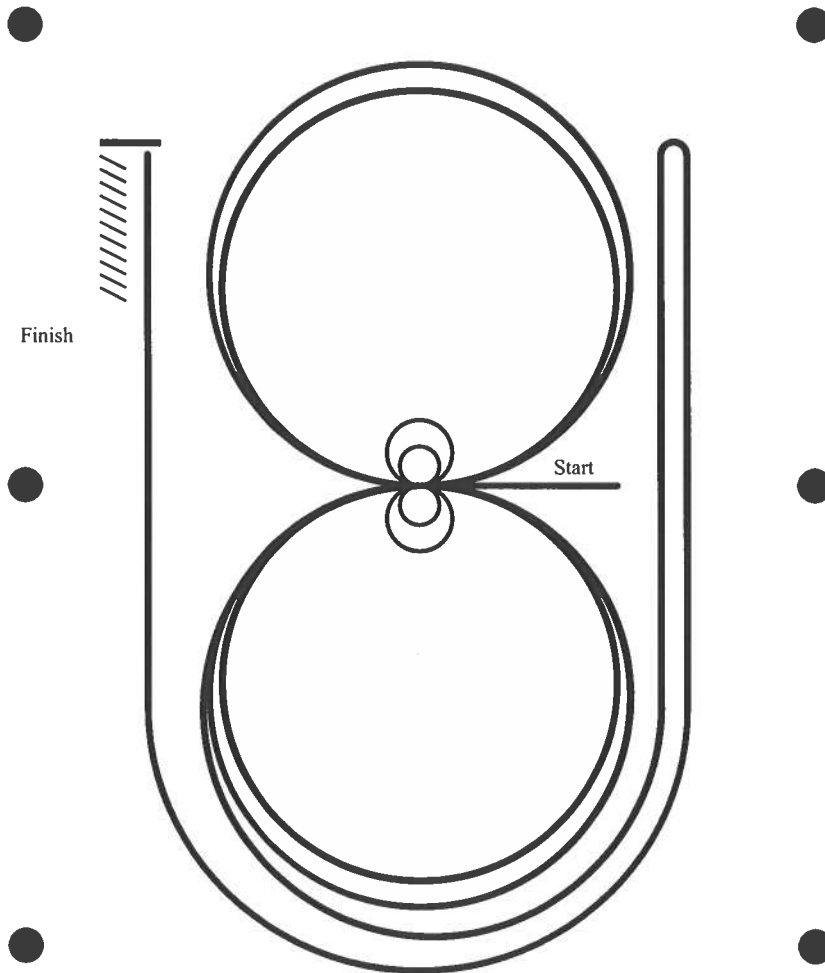

Horses may walk or trot to the center of the arena. Horses must walk or stop prior to starting the pattern.

1. Beginning on the left lead, complete two circles to the left. Stop at the center of the arena. Hesitate.
2. Complete two spins to the left. Hesitate.
3. Beginning on the right lead complete two circles to the right. Stop at the center of the arena. Hesitate.
4. Complete two spins to the right. Hesitate.
5. Beginning on the left lead, go around the end of the arena, run down the right side of the arena past center marker.
6. Continue around the end of the arena to run down the left side of the arena past the center marker. Stop. Back up.

Hesitate to show completion of pattern.

Generated from Equiscribe for iOS
Scan the code to see your results as they are posted



Saturday Patterns

6 judges

Showmanship

Show: Color Classic And Zone 3 Show

Date: Apr 14, 2023

Age Divisions

- 73. All Breed
- 77. Novice Youth
- 78. Youth 13/U
- 79. Youth 18/U
- 80. SPB Youth
- 81. Novice Amateur
- 82. Amateur
- 83. Masters Amateur
- 84. SPB Amateur

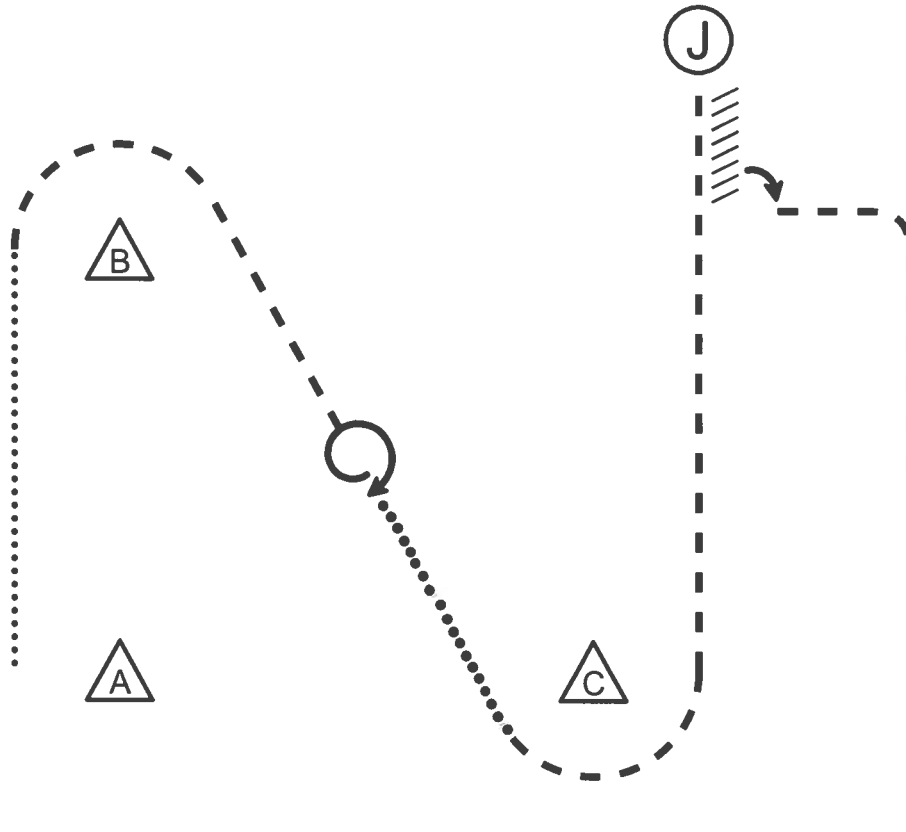

Be ready at A

1. Walk to B
2. Trot around B
3. Stop halfway to C and execute 360° turn
4. Extended walk to C
5. Pick up trot at C and trot to judge
6. Set up for inspection
7. When dismissed, back one horse length
8. Perform a 90° turn
9. Exit at a trot as shown

Generated from Equiscribe for iOS
Scan the code to see your results as they are posted



Showmanship

Show: Color Classic And Zone 3 Show

Date: Apr 14, 2023

Age Divisions

74. Leadline Non-APHA 3-8

76. Amateur W-T

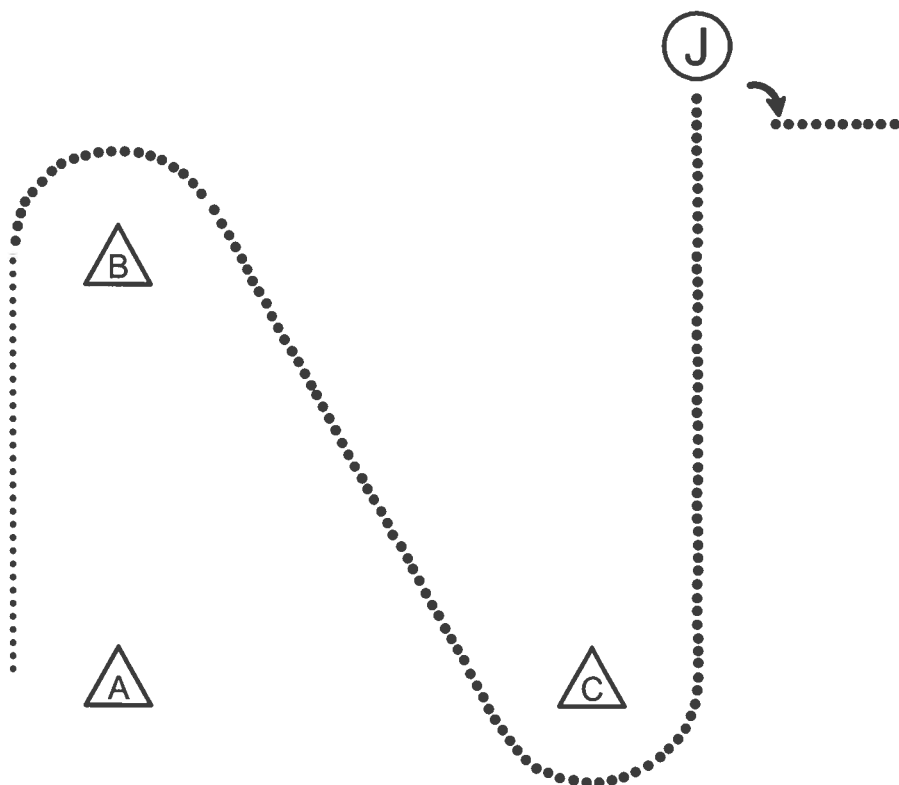

Be ready at A

1. Walk to and around B
2. Walk around C and straight to judge
3. Stop and set up for inspection
4. Perform a 90° turn
5. Walk to finish

Generated from Equiscribe for iOS
Scan the code to see your results as they are posted



Showmanship

Age Division

75. Youth W-T 5-10

Show: Color Classic And Zone 3 Show

Date: Apr 14, 2023

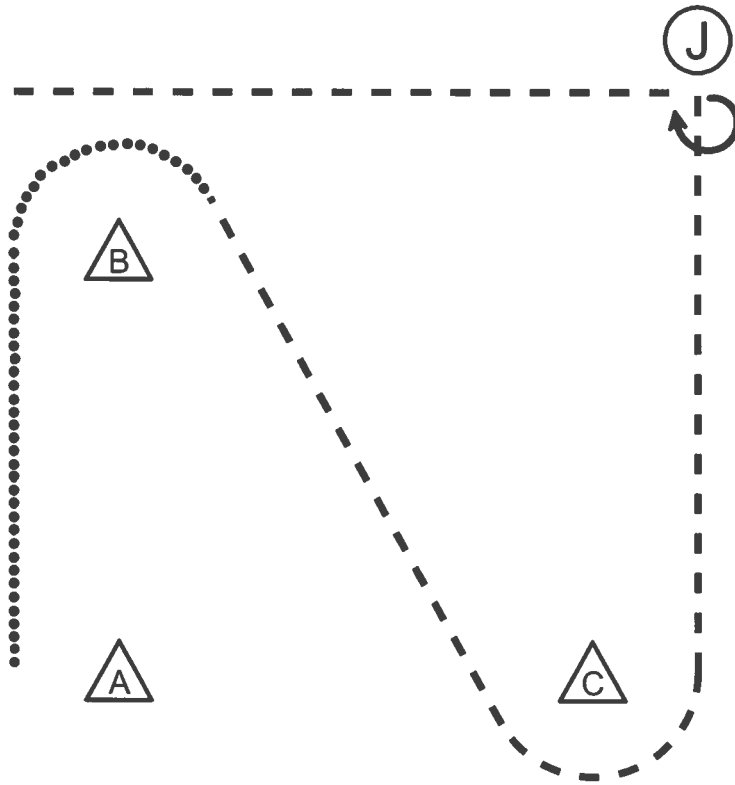

Be ready at A

1. Walk to and around B
2. Trot around C and straight to judge
3. Stop and set up for inspection
4. When dismissed, perform a 270° turn, trot away to finish

Generated from Equiscribe for iOS
Scan the code to see your results as they are posted



Saturday Patterns

4 judges

Trail

Age Division

116. Leadline Non-APHA 3-8

Show: Color Classic And Zone 3 Show

Date: Apr 14, 2023

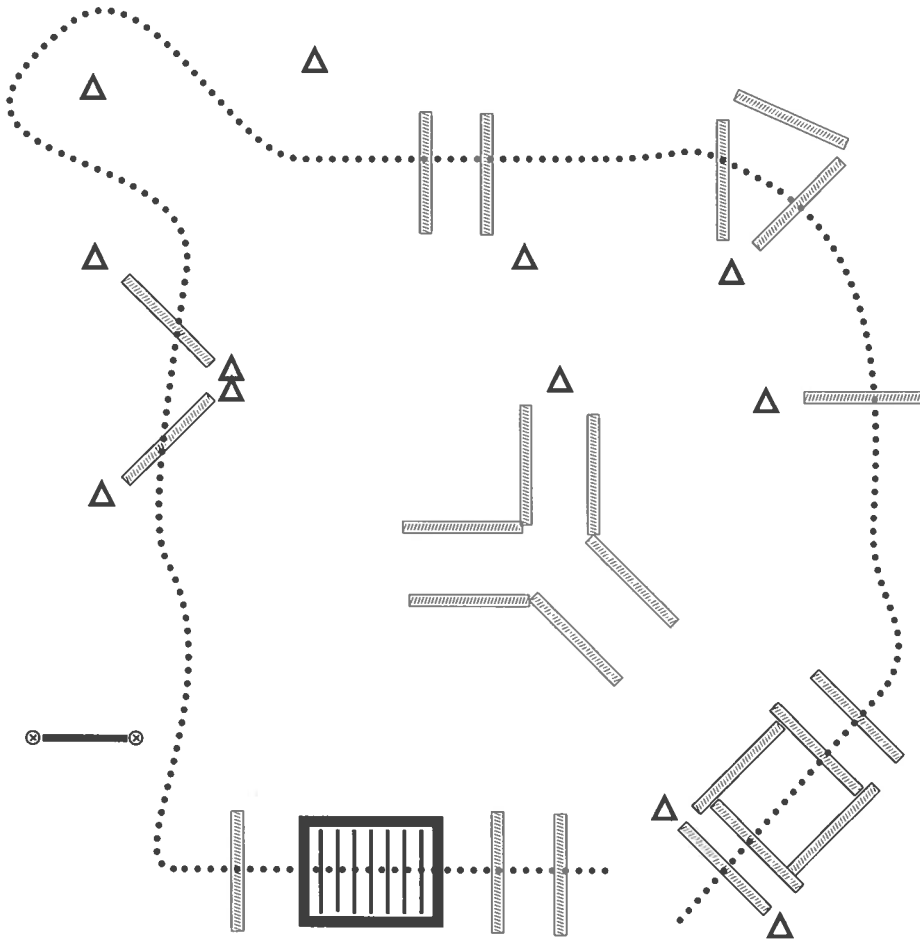

1. Walk over poles and through box
2. Walk over poles
3. Walk over poles
4. Walk through serpentine
5. Walk over pole and bridge

Generated from Equiscribe for iOS
Scan the code to see your results as they are posted



Trail

Show: Color Classic And Zone 3 Show

Date: Apr 14, 2023

Age Divisions

- 117. All Breed W-T & Yearling In
- 119. Amateur Yearling In-hand
- 120. Yearling In-hand
- 121. SPB Yearling In-hand
- 122. Youth W-T 5-10
- 123. Amateur W-T

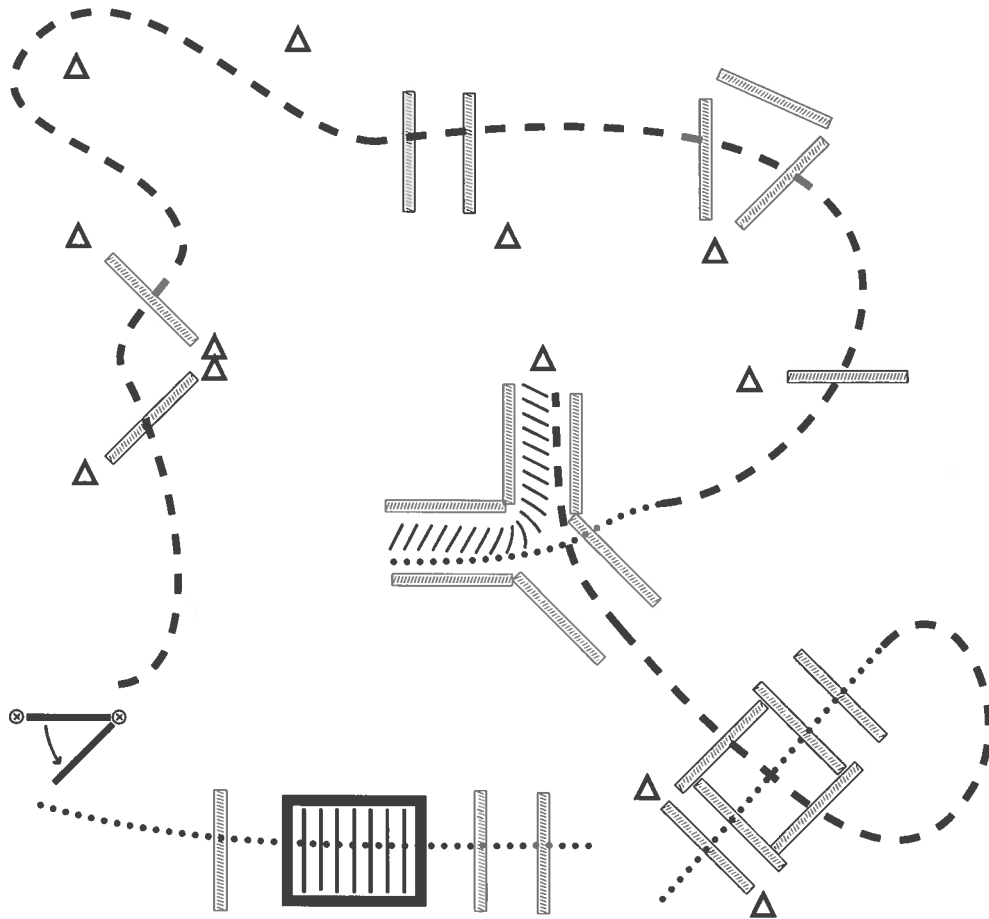

1. Walk over poles and through box
2. Trot through box and into chute
3. Back L
4. Walk out of L and trot over poles
5. Trot serpentine
6. Work left hand gate
7. Walk over poles and bridge to finish

Generated from Equiscribe for iOS
Scan the code to see your results as they are posted



Trail

Show: Color Classic And Zone 3 Show

Date: Apr 14, 2023

Age Divisions

- 118. All Breed
- 124. Novice Youth
- 125. Youth 18/U
- 126. SPB Youth 18/U
- 127. Green
- 128. Novice Amateur
- 129. Amateur
- 130. Masters Amateur
- 131. Open
- 132. SPB Amateur
- 133. SPB Open

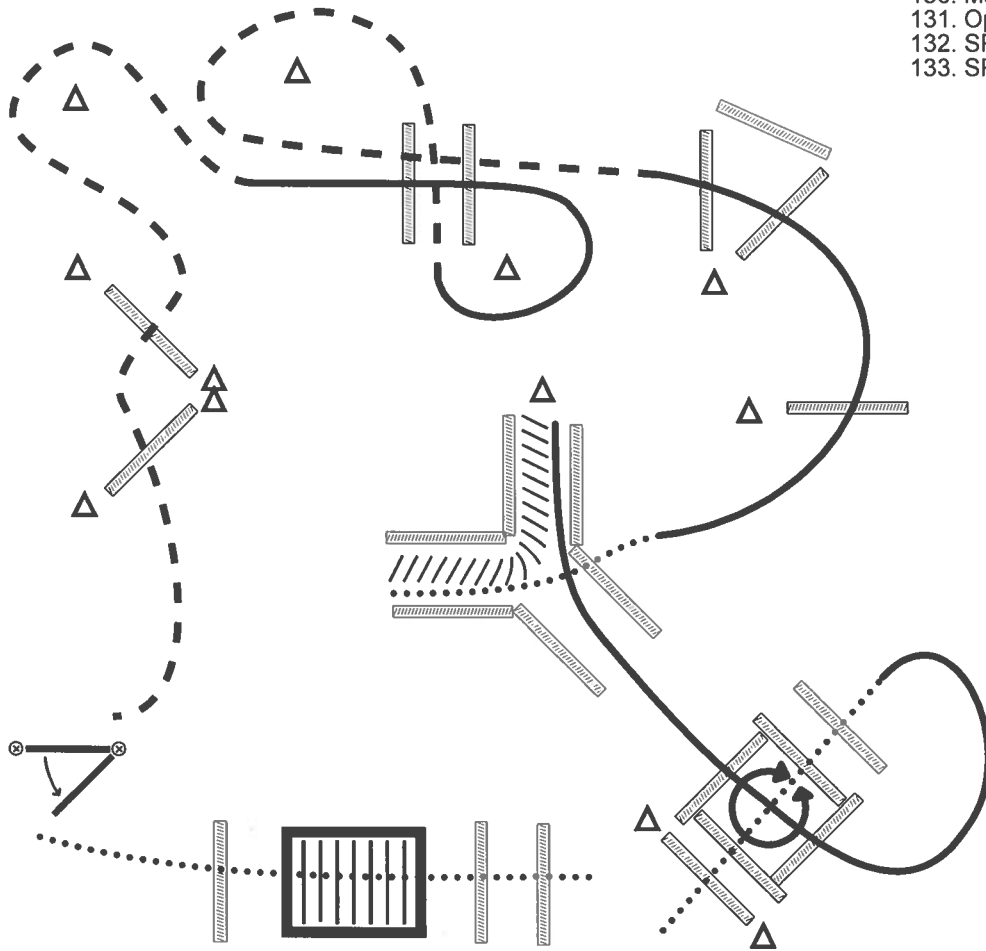

1. Walk into box, 360° either direction
2. Walk out, lope right lead through box and into chute
3. Back L
4. Walk out of chute, lope left lead over poles
5. Trot over poles, around cone
6. Lope around cone and over poles
7. Trot over poles to gate
8. Work left hand gate
9. Walk over poles and bridge to finish

Generated from Equiscribe for iOS
Scan the code to see your results as they are posted



Ranch Trail

Show: Color Classic And Zone 3 Show

Date: Apr 14, 2023

Age Divisions

- 134. All Breed Ranch
- 135. Youth Ranch 18/U
- 136. SPB Youth Ranch
- 137. Amateur Ranch
- 138. SPB Amateur Ranch
- 139. Open Ranch
- 140. SPB Open Ranch

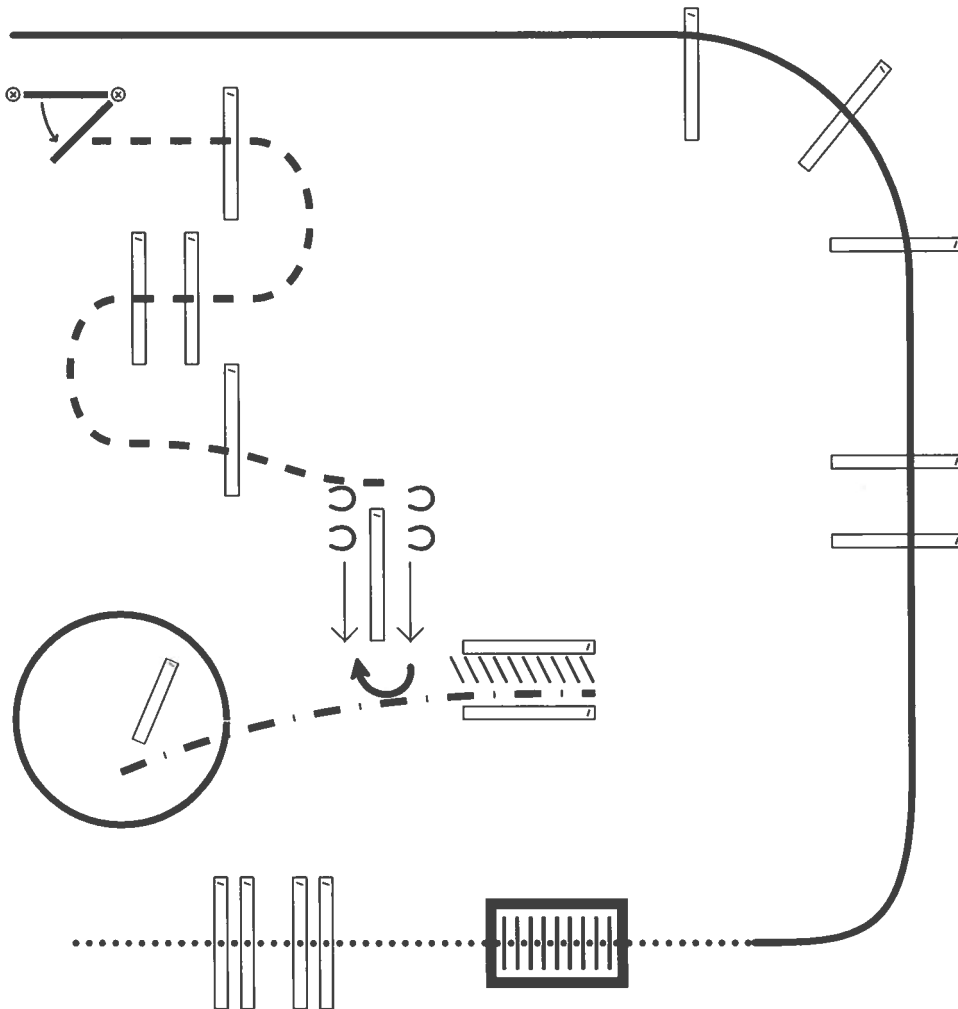

1. Walk over poles to bridge
2. Go over bridge at a walk
3. Lope left lead to gate
4. Open gate left hand
5. Trot thru obstacle 5
6. Sidepass log, 180° turn
7. Back into chute, extended trot to log drag
8. Drag log in circle either way

Generated from Equiscribe for iOS
Scan the code to see your results as they are posted



Ranch Pleasure

Show: Color Classic And Zone 3 Show

Date: Apr 14, 2023

Age Divisions

- 141. All Breed
- 142. Youth
- 143. SPB Youth
- 144. Amateur
- 145. SPB Amateur
- 146. Open
- 147. SPB Open

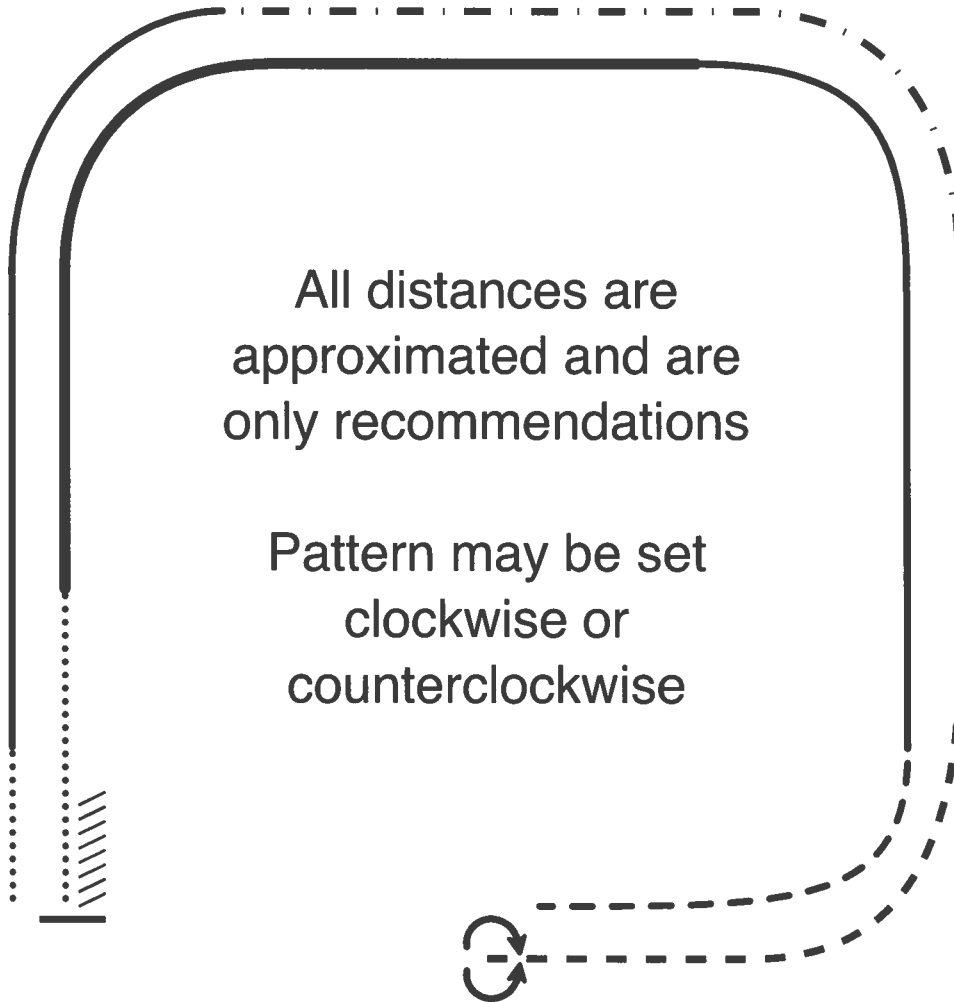

1. Walk
2. Lope
3. Extended trot
4. Trot
5. Stop; Reverse
6. Trot
7. Lope
8. Extended lope
9. Extended walk
10. Stop and back

Generated from Equiscribe for iOS
Scan the code to see your results as they are posted



Ranch Riding

Show: Color Classic And Zone 3 Show

Date: Apr 14, 2023

Age Divisions

- 189. All Breed
- 190. Novice Youth
- 191. Youth
- 192. SPB Youth
- 193. Novice Amateur
- 194. Amateur
- 195. SPB Amateur
- 196. Open
- 197. SPB Open

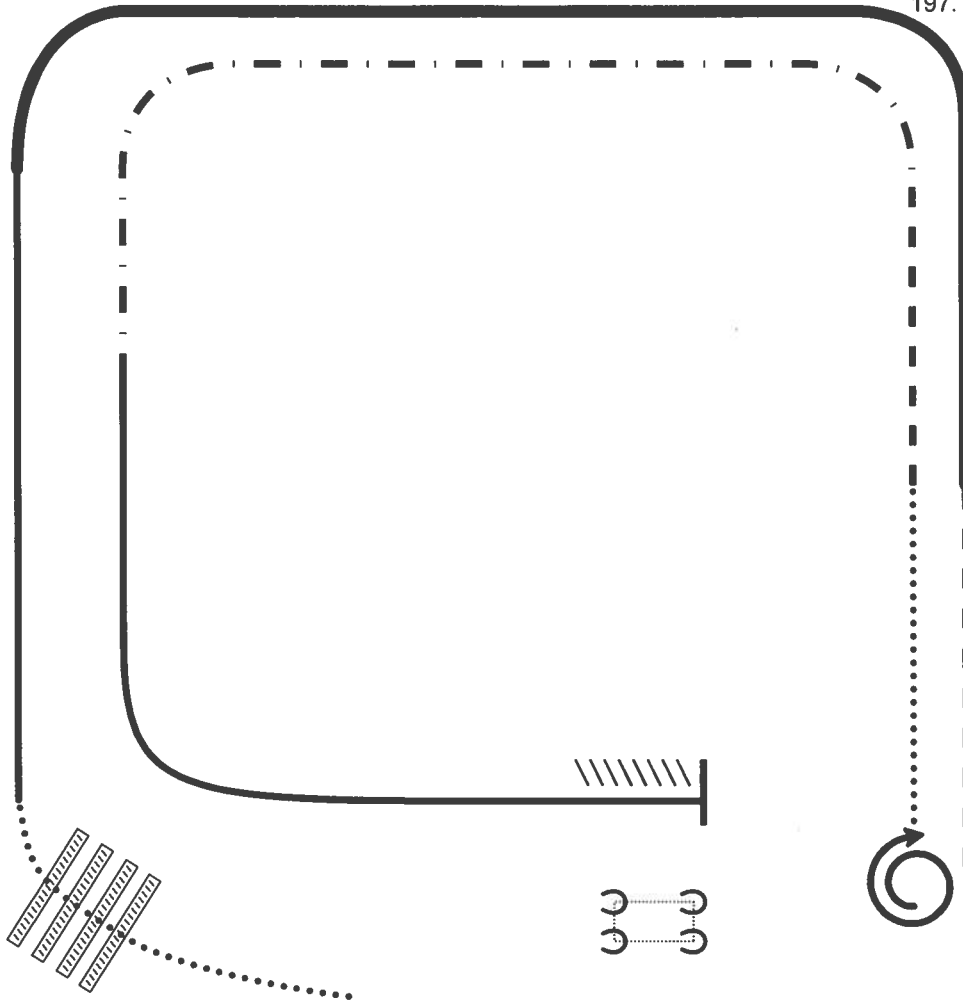

1. Walk
2. Walk over logs
3. Lope right lead
4. Extended lope (right lead)
5. Trot
6. Stop, 1 1/2 turns right
7. Walk
8. Trot
9. Extended trot
10. Lope left lead
11. Stop and back
12. Side pass right

Generated from Equiscribe for iOS
Scan the code to see your results as they are posted



Ranch Reining

Show: Color Classic And Zone 3 Show

Date: Apr 14, 2023

Age Divisions

198. Youth Ranch

199. Amateur Ranch

200. Open Ranch

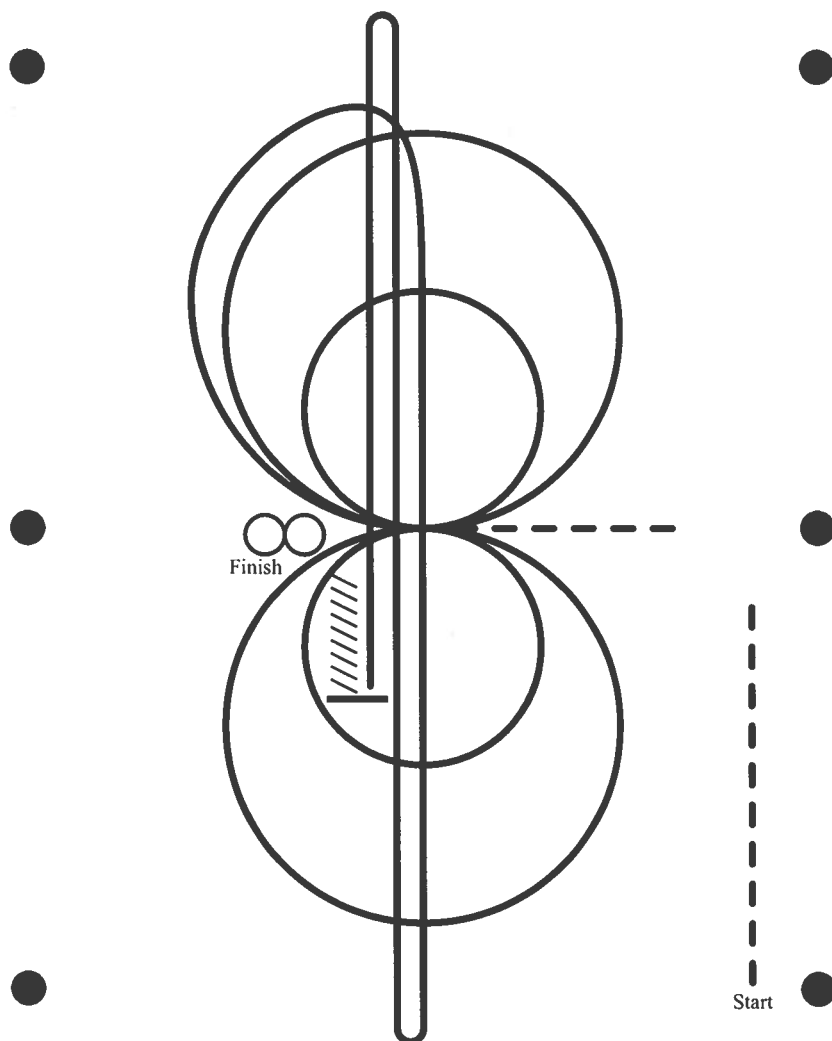

Trot to center of arena. Stop. Start pattern facing judge.

1. Beginning on the right lead complete two circles to the right, the first small and slow, the second large and fast
2. Complete two circles to the left, the first small and slow, the second large and fast. Change leads at the center
3. Begin a large circle to the right but do not close it. Run down the center of the arena past the end marker and
4. Run up the middle to the other end of the arena past the end marker and do a left roll back, no hesitation.
5. Run past the center marker. Stop, back 10 feet
6. Complete 1 spin right, then one spin left. Hesitate to complete pattern

Generated from Equiscribe for iOS
Scan the code to see your results as they are posted



Reining

Show: Color Classic And Zone 3 Show

Date: Apr 14, 2023

Age Divisions

- 201. All Breed
- 202. Youth 18/U
- 203. SPB Youth 18/U
- 204. Amateur
- 205. SPB Amateur
- 206. Open
- 207. SPB Open

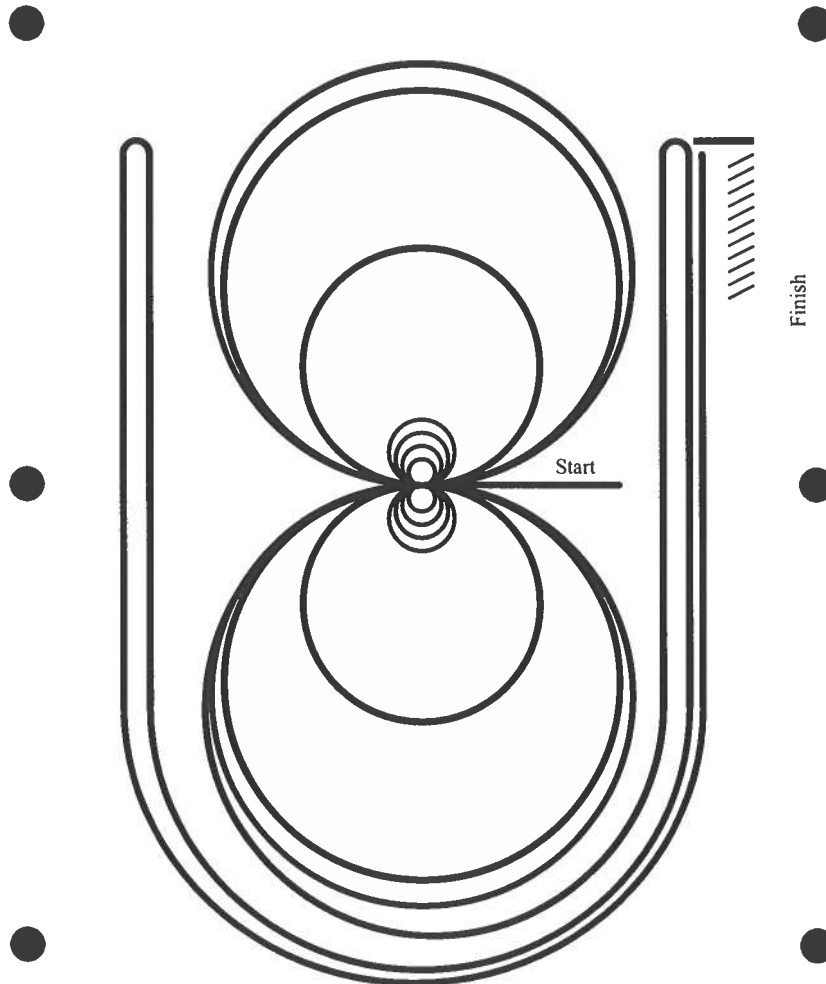

Horse must walk or stop prior to starting pattern. Beginning at the center of the arena facing the left.

1. Complete four spins to the right.
2. Complete four spins to the left. Hesitate.
3. Beginning on the left lead, complete three circles to the left: the first two circles large and fast; the third circle small and slow.
4. Complete three circles to the right: the first two circles large and fast; the third circle small and slow. Change lead.
5. Begin a large circle to the left but do not close this circle. Run up the right side of the arena past the center marker.
6. Continue back around previous circle but do not close this circle. Run up the left side of the arena past the center marker.
7. Continue back around previous circle but do not close this circle. Run up the right side of the arena past the center marker.

Rider may drop bridle to the designated judge.

Generated from Equiscribe for iOS
Scan the code to see your results as they are posted



Sunday Patterns

4 judges

English Equitation

Age Divisions

92. Youth W-T 5-10

108. Amateur W-T

Show: Color Classic And Zone 3 Show

Date: Apr 14, 2023

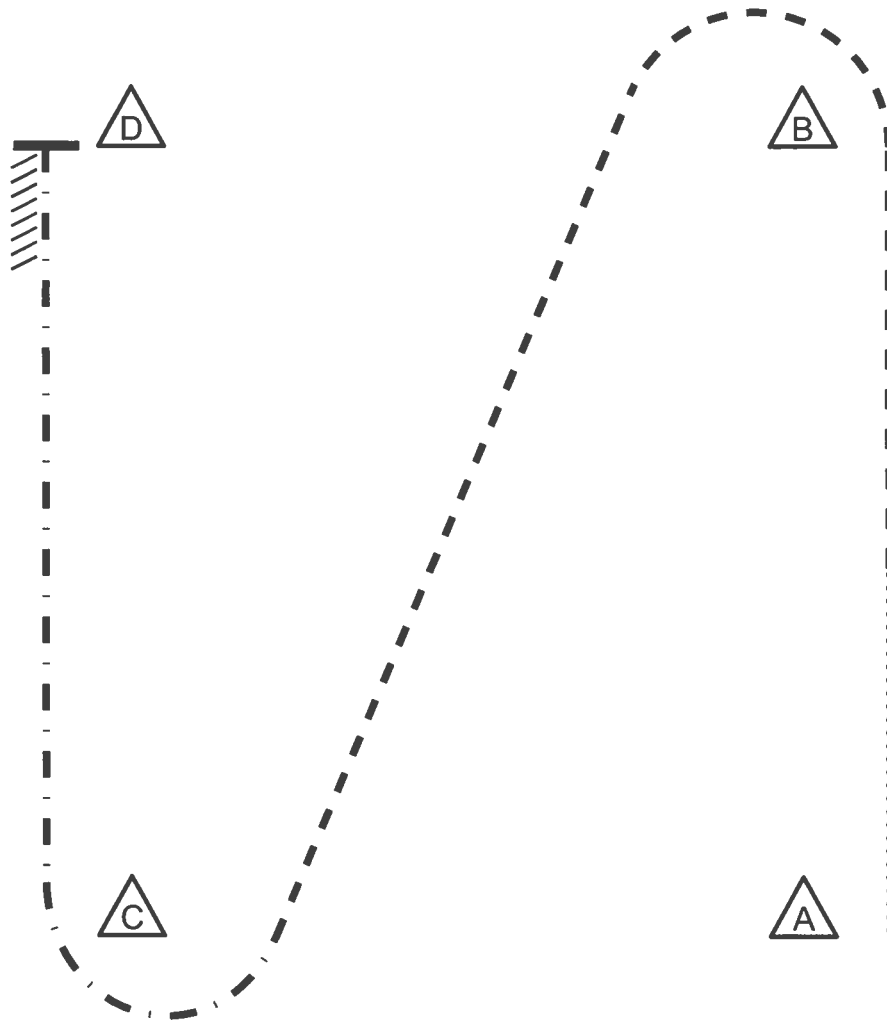

Be ready at cone A

1. Walk halfway to B, then posting trot on right diagonal around B to C
2. At C, sitting trot to D
3. Stop at D
4. Back 5 steps

Generated from Equiscribe for iOS
Scan the code to see your results as they are posted



English Equitation

Show: Color Classic And Zone 3 Show

Date: Apr 14, 2023

Age Divisions

- 104. All Breed
- 105. Novice Youth
- 106. Youth 13/U
- 107. Youth 18/U
- 109. Novice Amateur
- 110. Amateur
- 111. Masters Amateur
- 112. SPB Amateur

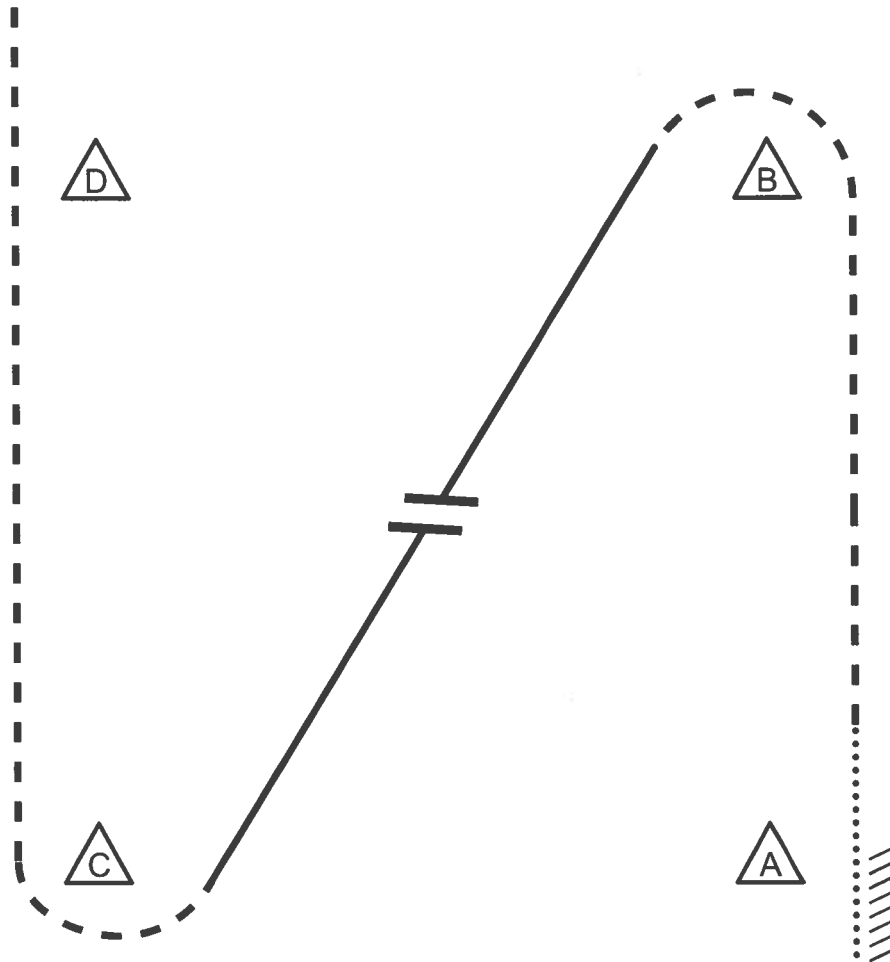

Pattern design by NULL

Be ready at cone A

1. Back four steps
2. Walk two horse lengths past A
3. Trot right diagonal around B
4. Canter left lead to middle
5. Simple lead change
6. Canter right lead to C
7. Trot left diagonal around C to D

Pattern is complete after passing D

Generated from Equiscribe for iOS
Scan the code to see your results as they are posted



Horsemanship

Age Divisions

152. Youth W-T 5-10

171. Amateur W-T

Show: Color Classic And Zone 3 Show

Date: Apr 14, 2023

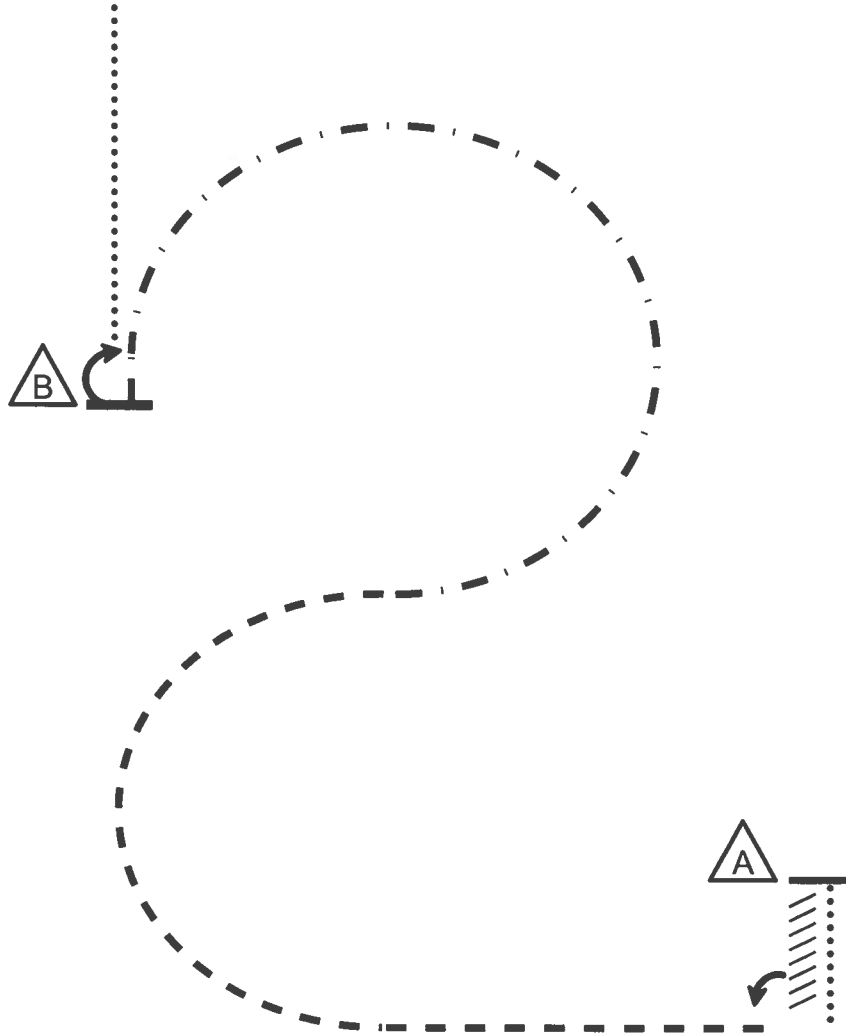

Be ready before marker A

1. Walk to A
2. Stop and back approximately one horse length
3. Execute a 90° turn to the left and jog a half circle
4. Extend the jog to B
5. Stop at B and execute a 180° turn to the right
6. Walk to exit

Follow the instructions of your ring steward

Generated from Equiscribe for iOS
Scan the code to see your results as they are posted



Horsemanship

Show: Color Classic And Zone 3 Show

Date: Apr 14, 2023

Age Divisions

- 166. All Breed
- 167. Novice Youth
- 168. Youth 13/U
- 169. Youth 18/U
- 170. SPB Youth 18/U
- 172. Novice Amateur
- 173. Amateur
- 174. Masters Amateur
- 175. SPB Amateur

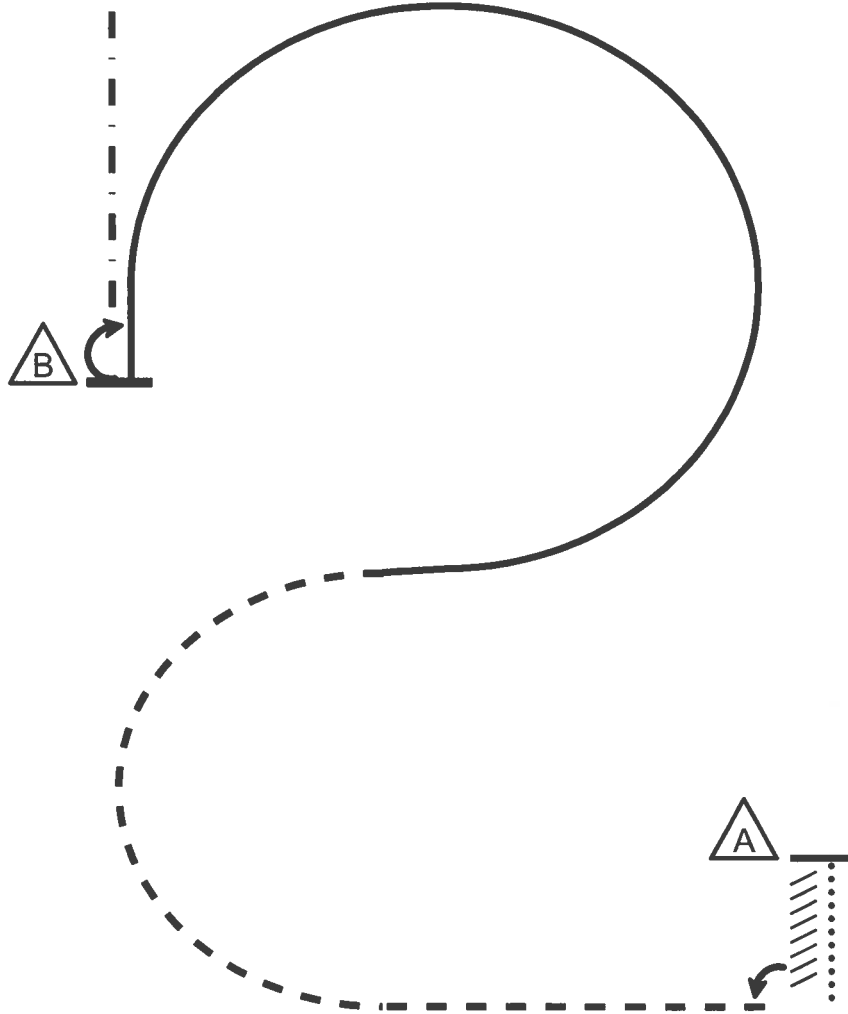

Be ready before marker A

1. Walk to A
2. Stop and back approximately one horse length
3. Execute a 90° turn to the left and jog a half circle
4. Lope on the left lead to B
5. Stop at B and execute a 180° turn to the right
6. Extended jog to exit

Follow the instructions of your ring steward

*Generated from Equiscribe for iOS
Scan the code to see your results as they are posted*



Western Riding

Age Division
178. Green

Show: Color Classic And Zone 3 Show

Date: Apr 14, 2023

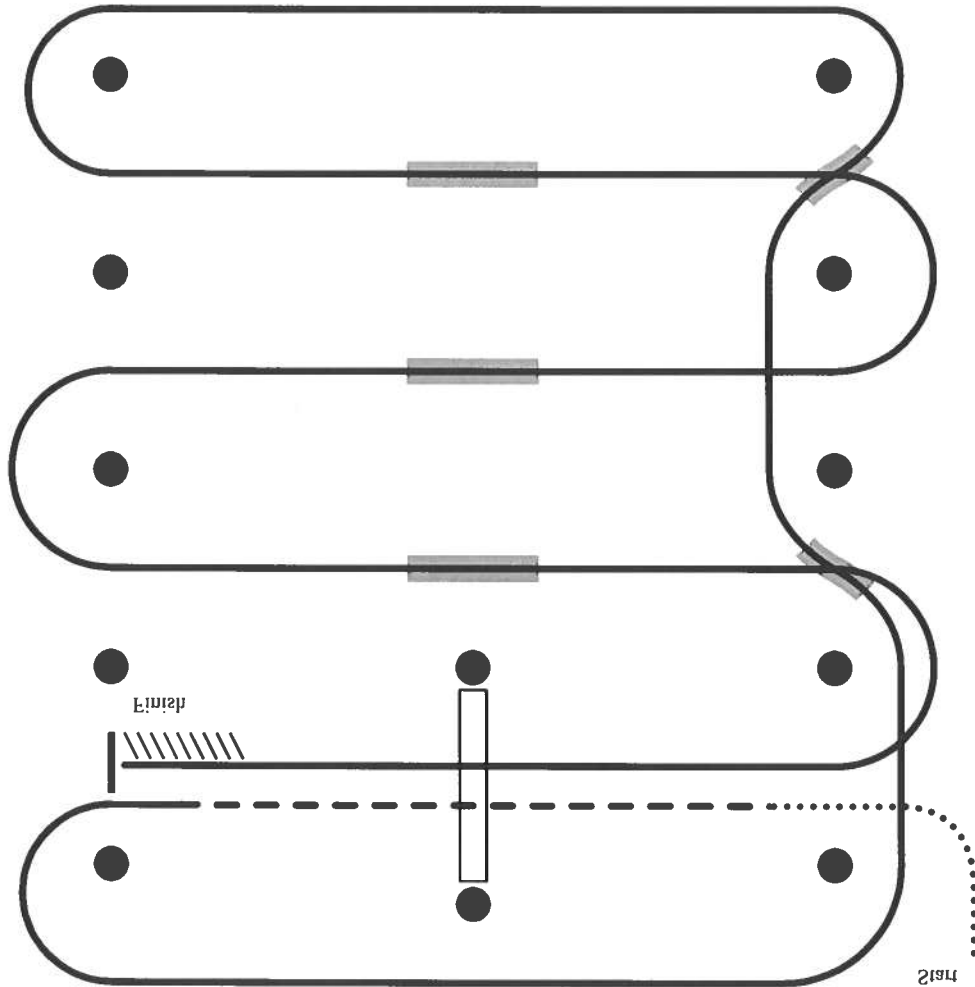

Pattern design by NULL

1. Walk, transition to jog, jog over log
2. Transition to the left lead and lope around end
3. First line change
4. Second line change, lope around end of arena
5. First crossing change
6. Second crossing change
7. Third crossing change
8. Lope over log
9. Lope, stop & back

Generated from Equiscribe for iOS
Scan the code to see your results as they are posted

