

ASSA[®]

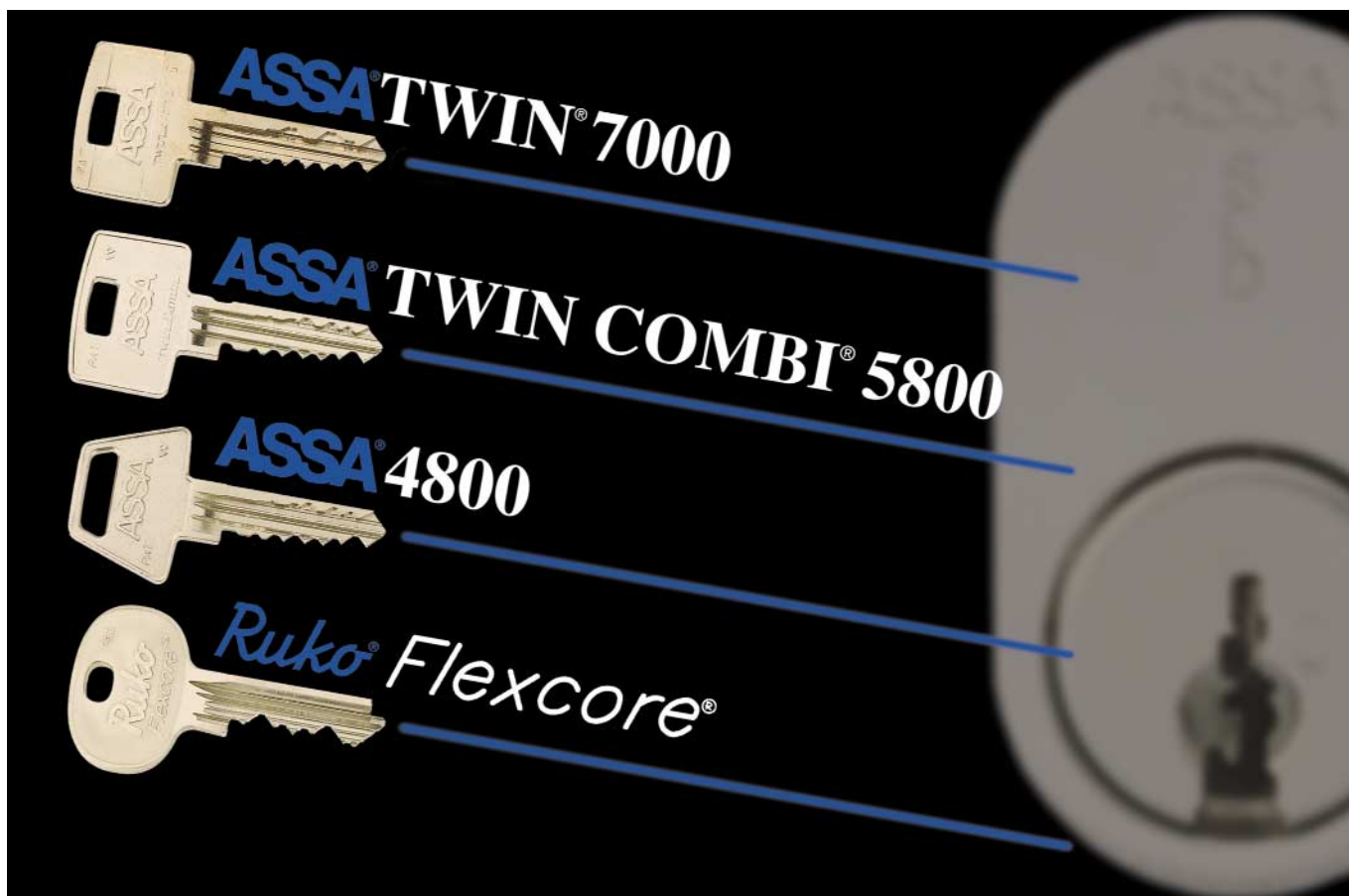

High Security CYLINDERS

ASSA[®]

An ASSA ABLOY Group company

ASSA cylinders – security at the highest level

High security cylinders

Cylinders and keys form the heart of any locking system. For many years, ASSA high security cylinders have been relied on to protect some of the most sensitive buildings and installations in the country. Drawing on this expertise, we have a continuous programme of development – producing new ranges of cylinders to ensure that our clients can continue to enjoy the highest possible level of security.

- Patent protected keys to ensure security.
- Cylinders designed to resist both surreptitious and forced entry.
- Available in a wide range of shapes to suit all common makes of lock.
- Fast, convenient service is available from your local ASSA Security Centre.



All ASSA Cylinders are covered by a full TEN YEAR GUARANTEE when used as part of a package with ASSA locks and door furniture.



Ruko Flexcore

10 PAT

Turn to page 4

Medium Security cylinder.
Five pin tumblers plus longitudinal pin.
Patent protected key and mechanism.



ASSA 4800

10 PAT

Turn to page 5

High Security cylinder.
Six pin tumblers plus sidebar.
Patent protected key and mechanism.



ASSA Twin Combi 5800

10 PAT

Turn to page 6

Very High Security cylinder.
Six pin tumblers plus sidebar with five sidepins.
Patent protected key and mechanism.
Dual security levels.



ASSA Twin 7000

10 PAT

Turn to page 7

Extremely High Security cylinder.
Six pin tumblers plus sidebar with five handed sidepins.
Patent protected key and mechanism.



Key control

Loss of key control is one of the most insidious threats to the security of a building. An intruder with an unauthorised copy of a key can gain access to sensitive areas silently and without leaving a trace. ASSA's system of key protection guards against this danger by ensuring that new keys are available only from agreed sources and with the correct authorisation.



We offer five different levels of key control, each with progressively greater restrictions on the availability of keys, to allow you to choose the appropriate balance between convenience and security.

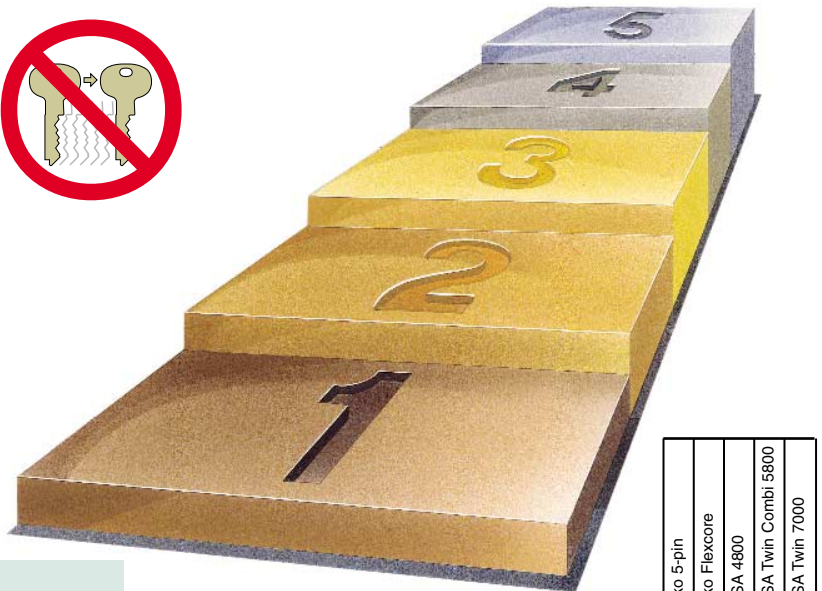

Patent Protection

Effective key control systems rely on the fact that keys are only available from specific, authorised security centres. Unfortunately, the abolition of copyright protection on keys from August 1999 has made it possible for anybody to make and sell most types of keys, thus bypassing this protection.

The only exception to this is key systems which are protected by up-to-date patents. Manufacturers are still able to take legal action against unauthorised third parties distributing copies of **patented** keys without permission. All registered key systems from ASSA – including the Ruko Flexcore, ASSA 4800, Twin Combi 5800 and Twin 7000 featured in this brochure – are protected by new international patents. We are committed to vigorously defending our patents whenever necessary to ensure the continued security of our customers.

	Ruko 5-pin	Ruko Flexcore	ASSA 4800	ASSA Twin Combi 5800	ASSA Twin 7000
STEP FIVE: CENTRAL REGISTRATION Keys are only available from ASSA. A strict system of registration is laid down involving authorised signatures and a code-marked keycard.					✓
STEP FOUR: STOCKIST REGISTRATION Keys are available from authorised ASSA Centres. A registration procedure is agreed between the customer and a specific stockist, setting out the procedure for obtaining extra keys.		✓		✓	
STEP THREE: IN-HOUSE REGISTRATION Keyblanks are available for sale to recognised end users, such as hotels, colleges and ships. Cutting of keys is then directly under the control of the customer.		✓	✓	✓	
STEP TWO: LOCAL REGISTRATION Keys can be purchased through authorised retailers. However, a Letter of Authority or official Order Form must be presented.		✓	✓	✓	
STEP ONE: UNREGISTERED Keys can be freely purchased through any retailer, with no restrictions on availability.	✓				

Master keying

A master key system allows each person to be issued with a key that will only open those doors appropriate to their role or job function. It therefore ensures both convenience and security.

ASSA has been designing and supplying master key systems for over 50 years. The formidable level of expertise developed by our specialist Systems Department as a result is at your disposal. Using the latest software and equipment, we can develop a system tailored to meet your specific requirements quickly and easily. Our national network of ASSA Security Centres can assemble and supply the system to you, thus ensuring fast, convenient local service.

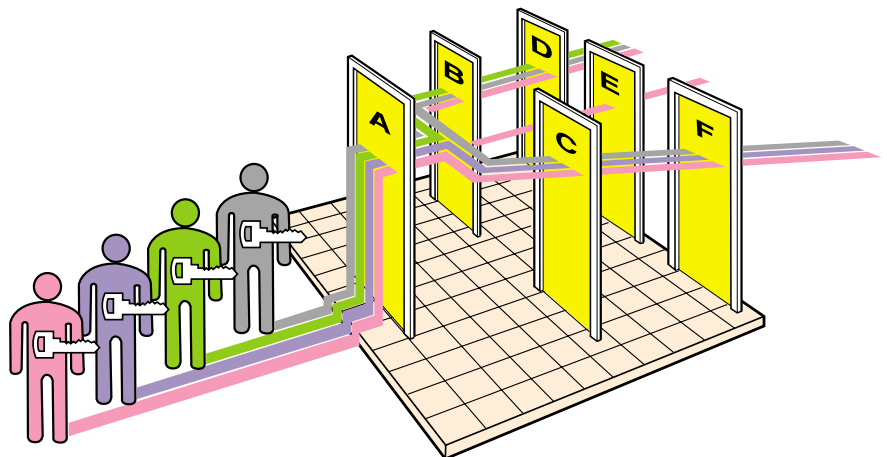

All ASSA cylinders and padlocks within a particular series may be master-keyed together, allowing an entire site to be included within the same system.

Keys are for people, not for locks

Ruko Flexcore



10 **PAT**

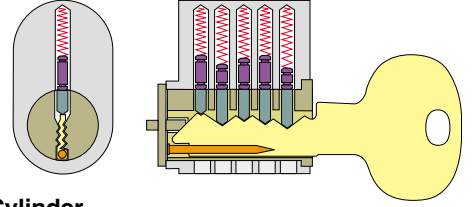

Medium Security Cylinder

- Five pin tumblers plus longitudinal pin. Mechanism and keyblanks are patented.
- Registered keys protected by international patents. Available at key control steps Two, Three and Four.
- Incorporates anti-pick protection.
- 29,000 usable combinations per profile.
- Designed for small to medium sized master key systems.

ASSA Oval Shape



Designed to suit Scandinavian type locks such as the ASSA Modular range.

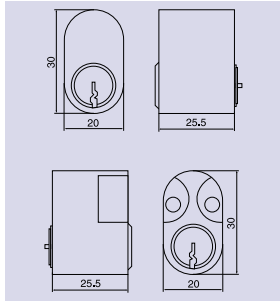

- F501** Single Cylinder - Outside
- F502** Double Cylinder
- F503** Single Cylinder - Inside
- F507** Rim Cylinder

Round Threaded



Designed to suit US pattern locks and rim nightlatches.

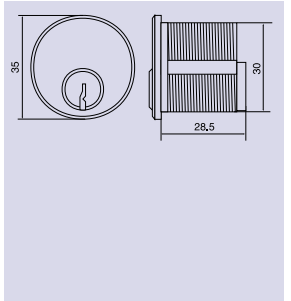

- F551** Single Cylinder
- F552** Double Cylinder
- F557** Rim Cylinder

Euro Profile



Designed to suit DIN pattern locks such as the ASSA Euro range.

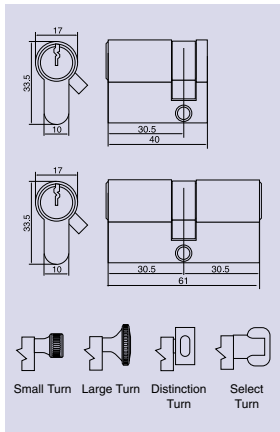

- F523** Single Cylinder
- F522** Double Cylinder
- Cylinders with Thumbturns:*
- F524** Small Turn
- F521** Large Turn
- F527** Distinction Turn
- F528** Select Turn

Also available in all sizes up to 141mm (single cylinder 80mm) in +5mm extensions.

UK Oval Profile



Designed to suit UK pattern locks such as the ASSA Compact range.

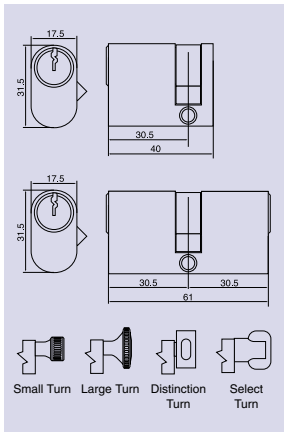

- F533** Single Cylinder
- F532** Double Cylinder
- Cylinders with Thumbturns:*
- F534** Small Turn
- F531** Large Turn
- F537** Distinction Turn
- F538** Select Turn

Also available in 71mm and 81mm sizes (single cylinder 45mm and 50mm).

Padlocks



Padlocks are available in open and close shackle versions at Grade 3 of the proposed CEN standard.

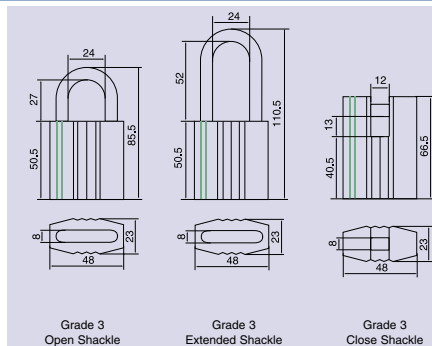

- F2541** Grade 3 Key Locking
- F2543** Grade 3 Ext. Shackle
- F2549** Grade 3 Close Shackle

ASSA 4800



10 **PAT**

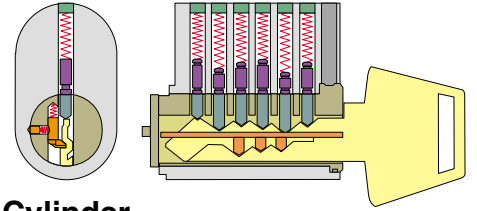

High Security Cylinder

- Six pin tumblers incorporating sidebar. Mechanism and keyblanks are patented.
- Registered keys protected by worldwide patents. Available at key control steps Two and Three.
- Incorporates anti-drill and anti-pick protection.
- 250,000 usable combinations.
- Designed for medium to large sized master key systems.

ASSA Oval Shape



Designed to suit Scandinavian type locks such as the ASSA Modular range.

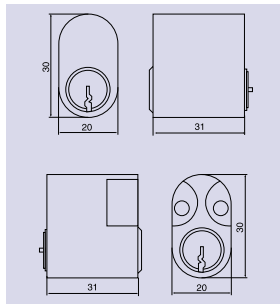

- 4801** Single Cylinder - Outside
- 4802** Double Cylinder
- 4803** Single Cylinder - Inside
- 4807** Rim Cylinder

Round Threaded



Designed to suit US pattern locks and rim nightlatches.

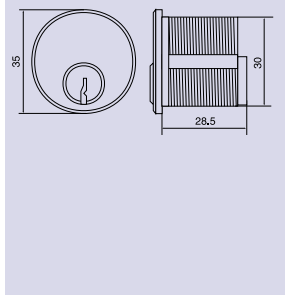

- 4851** Single Cylinder
- 4852** Double Cylinder
- 4857** Rim Cylinder

Euro Profile



Designed to suit DIN pattern locks such as the ASSA Euro range.

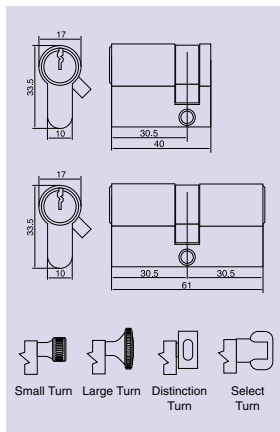

- 4823** Single Cylinder
 - 4822** Double Cylinder
- Cylinders with Thumbturns:*
- 4824** Small Turn
 - 4821** Large Turn
 - 4827** Distinction Turn
 - 4828** Select Turn

Also available in all sizes up to 141mm (single cylinder 80mm) in +5mm extensions.

UK Oval Profile



Designed to suit UK pattern locks such as the ASSA Compact range.

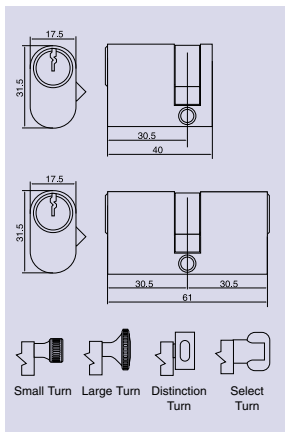

- 4833** Single Cylinder
 - 4832** Double Cylinder
- Cylinders with Thumbturns:*
- 4834** Small Turn
 - 4831** Large Turn
 - 4837** Distinction Turn
 - 4838** Select Turn

Also available in 71mm and 81mm sizes (single cylinder 45mm and 50mm).

Padlocks



Padlocks are available in open and close shackle versions at Grades 3 to 5 of the proposed CEN standard.

- 24840** Grade 3 Snap Locking
- 24841** Grade 3 Key Locking
- 24843** Grade 3 Ext. Shackle
- 24849** Grade 3 Close Shackle
- 34841** Grade 4 Key Locking
- 34849** Grade 4 Close Shackle
- 54849** Grade 5 Close Shackle

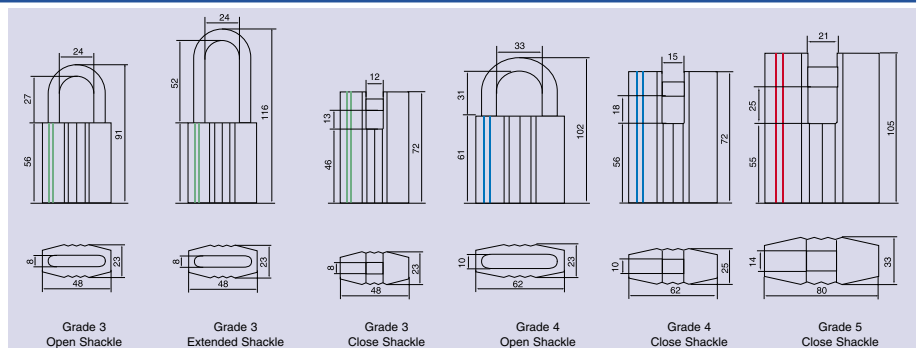

ASSA Twin Combi 5800



10 PAT

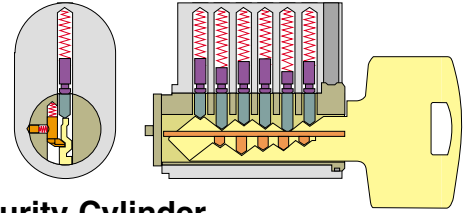

Very High Security Cylinder

- Six pin tumblers plus sidebar mechanism with five sidepins. Mechanism and keyblanks are patented.
- Registered keys protected by worldwide patents. Available at key control steps Two, Three and Four.
- Incorporates anti-drill and anti-pick protection.
- 1.9 billion usable combinations.
- Dual security levels: may be combined with lower cost medium security ASSA Combi 1800 cylinders in the same system.
- Designed for large or complex master key systems.

ASSA Oval Shape



Designed to suit Scandinavian type locks such as the ASSA Modular range.

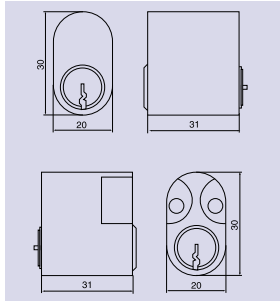

- C5801** Single Cylinder - Outside
- C5802** Double Cylinder
- C5803** Single Cylinder - Inside
- C5807** Rim Cylinder



Round Threaded

Designed to suit US pattern locks and rim nightlatches.

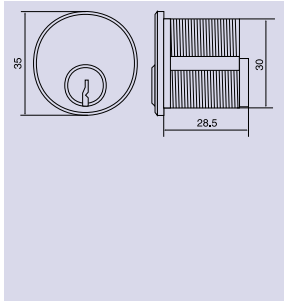

- C5851** Single Cylinder
- C5852** Double Cylinder
- C5857** Rim Cylinder

Euro Profile



Designed to suit DIN pattern locks such as the ASSA Euro range.

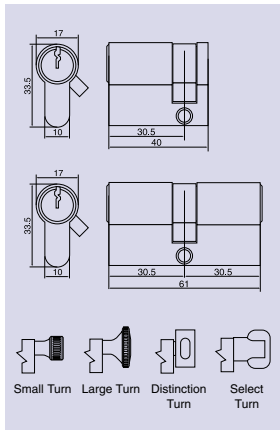

- C5823** Single Cylinder
 - C5822** Double Cylinder
- Cylinders with Thumbturns:*
- C5824** Small Turn
 - C5821** Large Turn
 - C5827** Distinction Turn
 - C5828** Select Turn

Also available in all sizes up to 141mm (single cylinder 80mm) in +5mm extensions.



UK Oval Profile

Designed to suit UK pattern locks such as the ASSA Compact range.

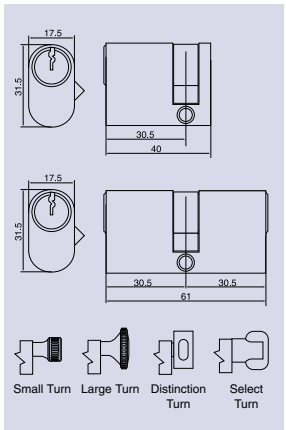

- C5833** Single Cylinder
 - C5832** Double Cylinder
- Cylinders with Thumbturns:*
- C5834** Small Turn
 - C5831** Large Turn
 - C5837** Distinction Turn
 - C5838** Select Turn

Also available in 71mm and 81mm sizes (single cylinder 45mm and 50mm).

Padlocks



Padlocks are available in open and close shackle versions at Grades 3 to 6 of the proposed CEN standard.

- C25841** Grade 3 Key Locking
- C25843** Grade 3 Ext. Shackle
- C25849** Grade 3 Close Shackle
- C35841** Grade 4 Key Locking
- C35849** Grade 4 Close Shackle
- C55849** Grade 6 Close Shackle

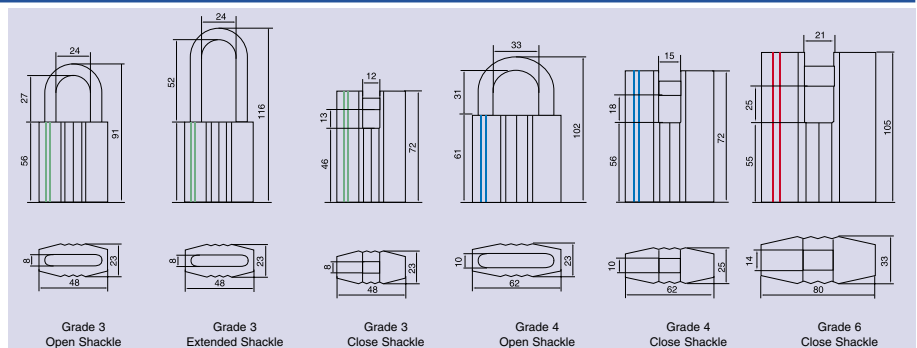

NOTE: References for ASSA Combi 1800 series cylinders begin C18- instead of C58- (for example C1823 for Euro Profile single cylinder).

ASSA Twin 7000



10 **PAT**

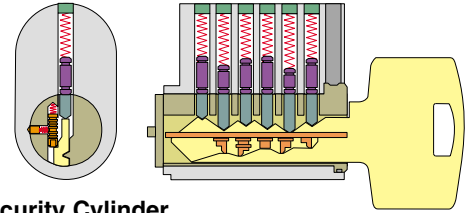

Extremely High Security Cylinder

- Six pin tumblers plus unique sidebar mechanism with five handed sidepins. Mechanism and keyblanks are patented.
- Registered keys protected by worldwide patents. Available at key control step Five only: cut keys are only available directly from ASSA.
- Incorporates anti-drill and anti-pick protection.
- Billions of usable combinations.
- Designed for large master key systems.

ASSA Oval Shape



Designed to suit Scandinavian type locks such as the ASSA Modular range.

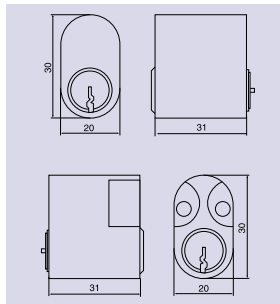

- 7601** Single Cylinder - Outside
- 7602** Double Cylinder
- 7603** Single Cylinder - Inside
- 7607** Rim Cylinder

Round Threaded



Designed to suit US pattern locks and rim nightlatches.

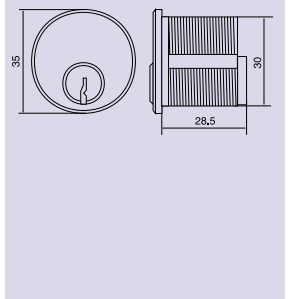

- 7651** Single Cylinder
- 7652** Double Cylinder
- 7657** Rim Cylinder

Euro Profile



Designed to suit DIN pattern locks such as the ASSA Euro range.

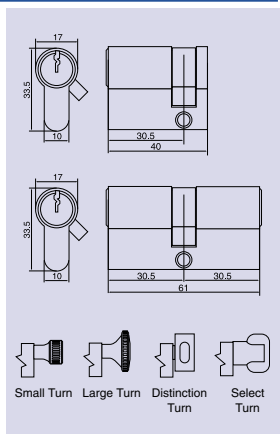

- 7623** Single Cylinder
 - 7622** Double Cylinder
- Cylinders with Thumbturns:*
- 7624** Small Turn
 - 7621** Large Turn
 - 7627** Distinction Turn
 - 7628** Select Turn

Also available in all sizes up to 141mm (single cylinder 80mm) in +5mm extensions.

UK Oval Profile



Designed to suit UK pattern locks such as the ASSA Compact range.

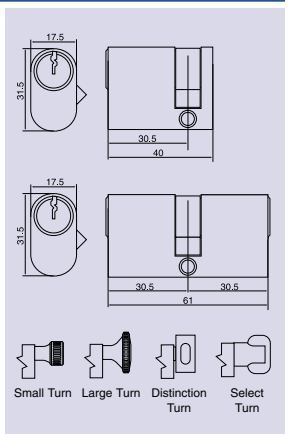

- 7633** Single Cylinder
 - 7632** Double Cylinder
- Cylinders with Thumbturns:*
- 7634** Small Turn
 - 7631** Large Turn
 - 7637** Distinction Turn
 - 7638** Select Turn

Also available in 71mm and 81mm sizes (single cylinder 45mm and 50mm).

Padlocks



Padlocks are available in open and close shackle versions at Grades 3 to 6 of the proposed CEN standard.

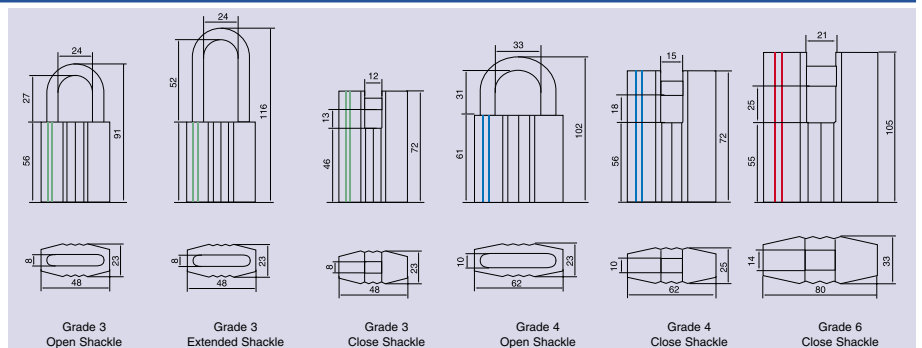

- 76241** Grade 3 Key Locking
- 76243** Grade 3 Ext. Shackle
- 76249** Grade 3 Close Shackle
- 76341** Grade 4 Key Locking
- 76349** Grade 4 Close Shackle
- 76549** Grade 6 Close Shackle

High security cylinders



- Key protection is ensured: all keys are registered and fully protected by international patents against unauthorised copying.
- Cylinders made from solid brass, stainless steel and other heavy-duty components for maximum resistance to wear and tear.
- Available in a comprehensive range of shapes to suit all standard makes of lock: ASSA Oval, Euro, UK Oval, Round Threaded and Rim.
- Master keyed and keyed to pass cylinders readily available.
- Euro Profile cylinders available in a complete range of different lengths to suit non-standard door and lock preparations.
- New cylinders can be fitted to existing locks, making security upgrades and refurbishments simple and inexpensive.
- Cylinders meet the requirements of BS EN 1303 at security grades three and four.
- Cylinders may be assembled and supplied by local ASSA Security Centres to ensure rapid and convenient service.
- Padlocks available in a wide variety of options. Tensile strength up to 10 tons – equivalent to Grades Three to Six of the proposed new standard prEN12320.
- Nickel silver used in keys and certain other components is self-lubricating, to ensure that the key operates smoothly.
- Heavy-duty keys resist bending and abuse, and are made of extremely hard-wearing nickel silver to ensure their durability.
- Available in satin chrome, polished chrome and polished brass; other finishes also available on selected products.
- Guaranteed for **ten years** when used as part of a complete package of ASSA locks and door furniture.

ASSA® ASSA Limited, 75 Sumner Road, Croydon CR0 3LN
Tel: 0181 688 5191 Fax: 0181 688 0285
E-mail: sales@assa.co.uk Web: www.assa.co.uk

Your local ASSA stockist is:

An ASSA ABLOY Group company

ASSA Ltd produces a comprehensive range of innovative, high quality security products. Our clientele includes some of the most demanding government, commercial and institutional organisations.

The ASSA ABLOY Group is the world's leading manufacturer and supplier of locks and associated products, dedicated to satisfying end-user needs for security, safety and convenience.