

ONSRUD

ONSRUD CUTTER LP

CNC Production Routing Guide



Leitz Metalworking Technology Group

PRODUCTION ROUTING GUIDE

TABLE OF CONTENTS

INTRODUCTION.....	page 3
CUTTING TOOL MATERIALS.....	page 4
CUTTING TOOL GEOMETRY.....	page 5
TOOL WEAR.....	page 6
FEEDS & SPEEDS.....	page 7
FEEDS & SPEEDS FORMULAS.....	page 8
COLLETING & MAINTENANCE.....	page 9-12
FIXTURING AND SPOILBOARD TECHNIQUES.....	page 13-15
PROGRAMMING TECHNIQUES.....	page 15-16
TOOL SELECTION.....	page 17
VALUE ANALYSIS.....	page 18
ROUTING WOOD.....	page 19
ROUTING PLASTIC.....	page 19-21
ROUTING ALUMINUM.....	page 22-24
TROUBLE SHOOTING/TOOL BREAKAGE.....	page 25-26
GLOSSARY.....	page 26-29

MISSION STATEMENT

The mission of Onsrud Cutter, LP is to provide cutting tool solutions that exceed our customers' expectations.

Our success is measured by achieving outstanding customer productivity, providing exceptional value and extraordinary service, and attaining superior financial results. Our commitment to innovative thought and investment in technology drives our organizational growth.

INTRODUCTION

Companies purchasing a CNC router act only after a thorough study of the machines in the market place. Prospective router buyers assess individual needs and scrutinize the appropriate machinery, configurations, and options prior to actual purchase. This can be an intimidating experience because of the scope and depth of the information involved in such a transaction.

Unfortunately, many times this exhaustive process of selecting the correct machine occurs without much regard to the tooling and the influence of application based tooling on the optimum performance of the machine.

The purpose of the CNC Production Routing Guide by Onsrud Cutter LP is to enhance the tool selection process and educate the CNC user regarding the proper techniques to maximize productivity.

Acknowledgement

The body of work is the effort of many past and present employees of Onsrud Cutter LP who are dedicated to serving the CNC router market by finding “*The Right Tool for Your Job*”.

All rights reserved. This book may not be reproduced in whole or in part in any form or by any means without written permission from the publisher.

CUTTING TOOL MATERIALS

Tool materials utilized in the manufacture of router bits in the industrial market place involve high-speed steel, carbide tipped, solid carbide, and PCD diamond. The choice of tooling depends upon the relative characteristics of the material being machined and the equipment available for a specific application. High-speed steel and carbide tipped tools tend to fall into the category of manually fed router applications while solid carbide and PCD diamond is best applied to CNC operations. Basically, as hardness of tool material increases and toughness decreases, the tooling of the harder material functions better in the consistent feeding environment of CNC machinery.

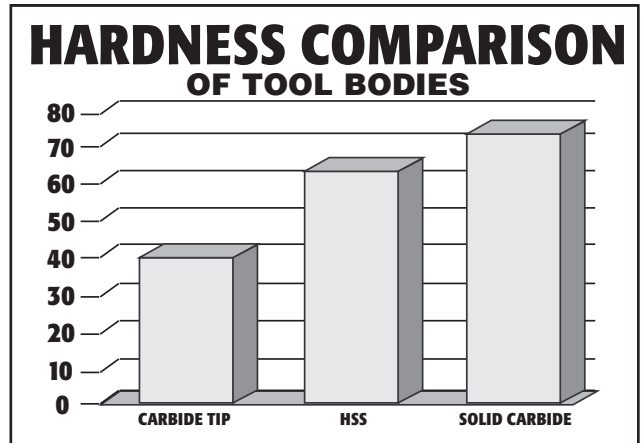
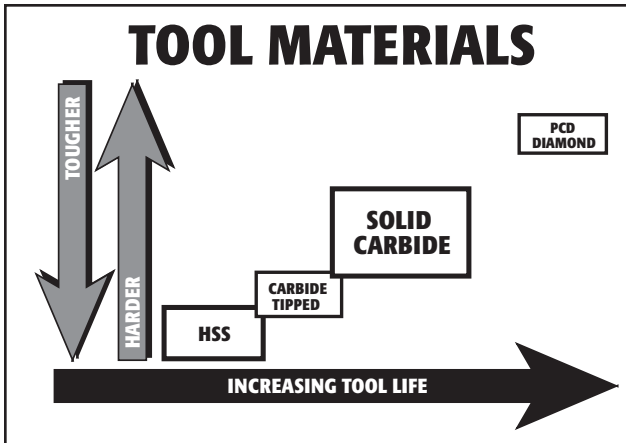

HSS-HIGH SPEED STEEL

<p>PROS:</p> <ul style="list-style-type: none"> LOWER COST TOOLING TOUGH BODIES REDUCE BREAKAGE IN OLDER SPINDLES AND HAND ROUTERS SHARPER EDGES ALLOW EASIER HAND FEEDING DO NOT BIND AS MUCH IN "WARM" THERMOFORMED PLASTIC PARTS MANY GEOMETRIES AVAILABLE LONG CEL'S AVAILABLE 	<p>CONS:</p> <ul style="list-style-type: none"> CAN EXPERIENCE VIBRATION PROBLEMS DUE TO REDUCED RIGIDITY SHORTER TOOL LIFE DUE TO REDUCED ABRASION RESISTANCE SLOWER FEED RATES THAN OTHER TOOL MATERIALS
---	--

CARBIDE TIPPED

<p>PROS:</p> <ul style="list-style-type: none"> LOWER COST LONG LIFE WITH A TOUGH BODY GOOD FOR HAND ROUTING OF ABRASIVE MATERIALS 	<p>CONS:</p> <ul style="list-style-type: none"> REDUCED RIGIDITY SLOW FEED RATES LIMITED GEOMETRIES AVAILABLE LONG CEL'S NOT USUALLY AVAILABLE IN SMALL DIAMETERS POOR PLUNGING ABILITY
--	---

SOLID CARBIDE

<p>PROS:</p> <ul style="list-style-type: none"> BEST RIGIDITY - BEST FINISH HIGH FEED RATES AND REDUCED CYCLE TIMES LARGEST VARIETY OF GEOMETRIES LONG TOOL LIFE MULTIPLE RESHARPENINGS BEST PLUNGING CAPABILITIES 	<p>CONS:</p> <ul style="list-style-type: none"> HIGH INITIAL COST INCREASED BREAKAGE IF NOT USED IN WELL-MAINTAINED MACHINERY ALUMINUM AND PLASTIC TOOLING IS FREQUENTLY NOT RESHARPENABLE
---	--

PCD DIAMOND

<p>PROS:</p> <ul style="list-style-type: none"> LONG TOOL LIFE IN ABRASIVE MATERIALS 	<p>CONS:</p> <ul style="list-style-type: none"> VERY HIGH INITIAL COST POOR PLASTIC, SOFT WOOD, AND ALUMINUM GEOMETRY TYPICALLY CANNOT PLUNGE LIMITED FEEDRATES DUE TO STEEL BODIES AND FLATFACE GEOMETRY
--	--

CUTTING TOOL GEOMETRY

Cutting tool geometry influences many factors including the type of chip produced, the flow of the chip, the finish, and the actual force placed on the part. Consequently, it is important to understand the basic terms associated with tool geometry and how these influences effect the machining process.

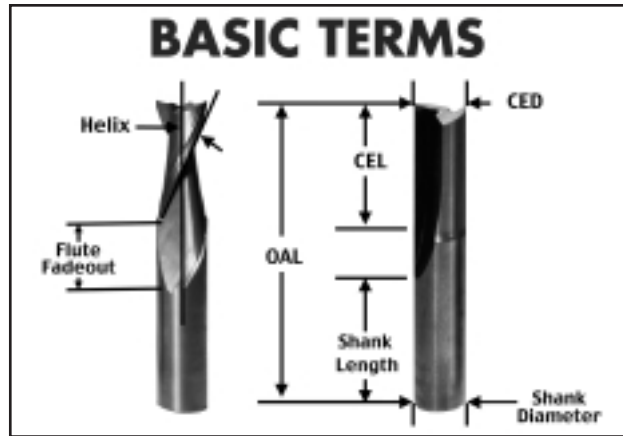

OAL= overall length CEL= cutting edge length
CED = cutting edge dia.

RAKE & CLEARANCE

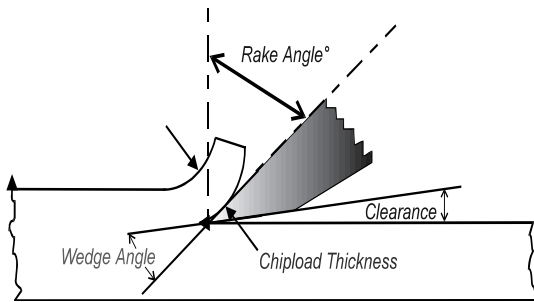

RAKE & CLEARANCE

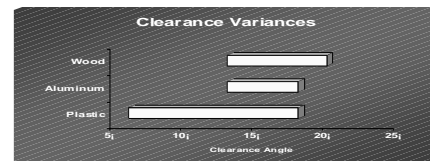
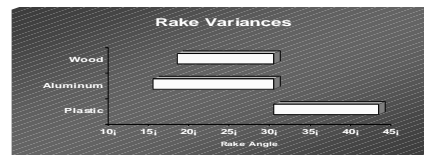

HELIX



UPCUT HELIX

PRO: BEST FINISHES
GOOD CHIP EXTRACTION
CON: SOMETIMES LIFTS PARTS

DOWNCUT HELIX

PRO: HELPS HOLD PARTS DOWN
CON: SOMETIMES REWELDS CHIPS
CHATTERS ON UNSUPPORTED PARTS

TOOL TYPES

- STRAIGHT "O" FLUTE - SOFT WOOD/SOFT PLASTIC
- SPIRAL "O" FLUTES - PLASTICS/ALUMINUM
- "V" FLUTES - HARDWOOD/HARD PLASTIC/COMPOSITES
- FINISHERS - HARD PLASTICS/HARDWOODS
- ROUGHERS - ALL WOODS/COMPOSITES
- CHIPBREAKER/FINISHERS - ALL WOODS
- COMPRESSION SPIRALS - LAMINATED WOODS
- WOOD ROUTS - ALL WOODS
- STANDARD SPIRALS - ALUMINUM/COMPOSITES

HOW GEOMETRY WORKS IN WOOD

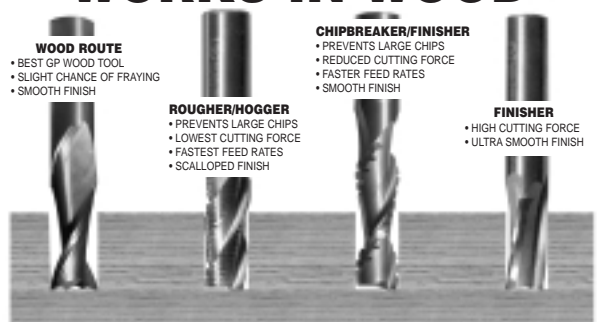

HOW GEOMETRY WORKS IN PLASTICS

WHY ARGUE WITH THE MATERIAL?

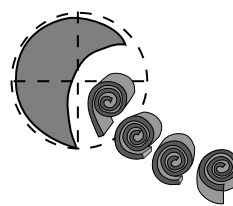

NATURAL CHIP FORMATION IN SOFT PLASTICS IS A CURL

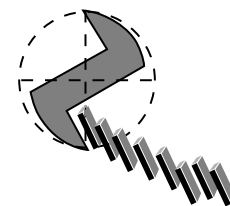

NATURAL CHIP FORMATION IN HARD PLASTICS IS A BLOCK OR LOOSE CURL.

TOOL WEAR

GENERAL TOOL WEAR DEFINITIONS

FLANK WEAR – Clearance or relief side of the edge is wearing or rubbing. This is how most router bits wear. Clearance side of the cutting edge should rub a little for controlling feed and vibrations during a cut.

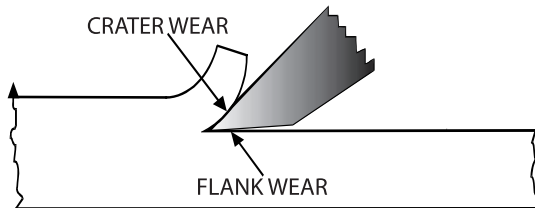

CARBIDE WEAR

- SOLID CARBIDE BITS ARE MADE OF
 - 4%-16% COBALT (CO)
 - 80%-96% TUNGSTEN CARBIDE (W)
 - TRACE AMOUNTS OF "SPECIAL SAUCE"
- COBALT ACTS AS A BINDER OR "GLUE" FOR THE MATERIALS
- COBALT IS VERY REACTIVE. IT WOULD MUCH RATHER BOND WITH OTHER REACTIVE SUBSTANCES THAN WITH CARBIDE, THIS IS CALLED ATOMIC TRANSFER OR HOT CORROSION.

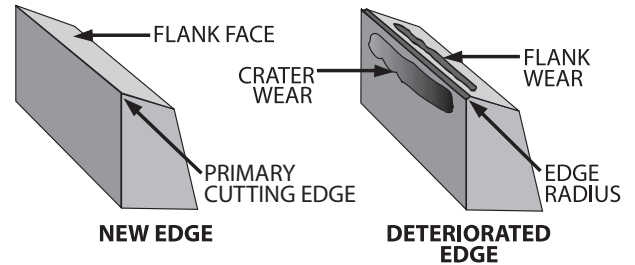

CRATER WEAR – Rake face side of the tools edge is wearing. Normally this is due to a very abrasive material flowing over the surface of the rake face. This is very rare in routing. However, with greater and greater chip loads, this may become more of a factor.

EDGE RADIUS – Localized wear of the very tip of the tool edge. This is really a combination of both of above but concentrated on the very edge.

CATASTROPHIC FAILURE – Chipping or breakage due to hitting something harder than the edge material or the tool and/or edge was too weak for the geometry or application of the tool.

THE DULLING PROCESS OF CARBIDE

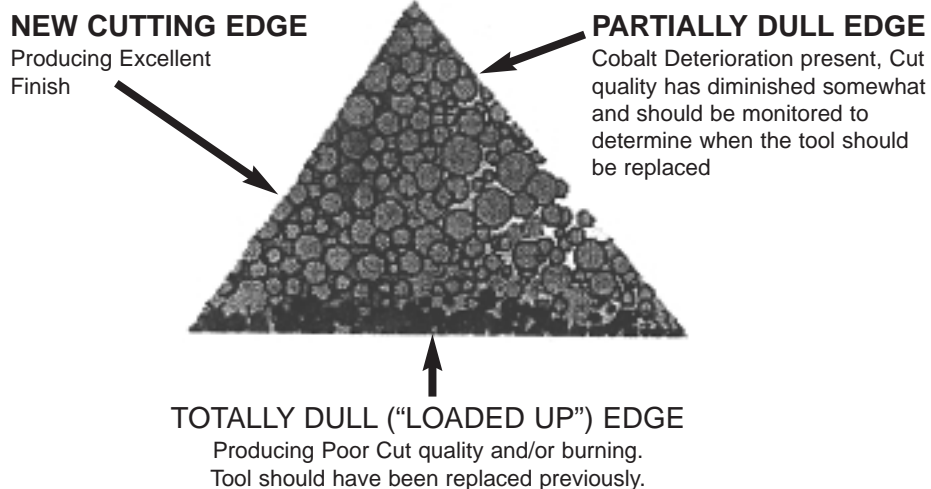

Edge deterioration is due to hot corrosion of atomic transfer of the cobalt binder at the surface of the cutting edge. Heat generated during the process causes this phenomenon. Hot corrosion can not be halted, but creating larger chips during

the machining process may substantially slow it. Since the formation of chips is a function of feeds and speeds, it is critical to understand the concept of chip formation and how it reduces heat.

FEEDS & SPEEDS

To understand the concept of speeds and feeds, it is necessary to visualize what occurs at the cutting edge of the tool. A chip or thickness of material is being removed from the base part. The size and thickness of the chip is controlled by the rotation speed of the spindle and the forward movement of the tool into the material. In a single flute tool, the chip load is equal to the amount of material cut by one edge in one revolution of the spindle. The actual chipload remains the same with multi-flute tools but the chipload is spread over the number of flutes in the cut per revolution.

FINDING THE RIGHT FEED AND SPEED

- START AT THE LOW END OF THE MANUFACTURER'S FEED AND SPEED RECOMMENDATIONS.
- USE THE FEED RATE OVERRIDE TO INCREASE THE FEED RATE UNTIL:
 - THE EDGE FINISH DETERIORATES BECAUSE OF TOOL CHATTER
 - THE MACHINE DEFAULTS TO A SLOWER SPEED DUE TO TIGHT RADII.
 - THE PART IS PUSHED OFF THE VACUUM.
- ONCE THE MAX FEED RATE IS DISCOVERED, RUN 90% OF THE MAX FEED RATE AND REDUCE THE SPINDLE RPM UNTIL THE EDGE FINISH ONCE AGAIN DETERIORATES.
- THIS IS THE POINT OF MAXIMUM PRODUCTIVITY AND BEST TOOL LIFE

REDUCING TOOL WEAR

- PICK THE RIGHT TOOL FOR THE JOB!
- INCREASE CHIPLOAD
 - INCREASE FEED RATES
 - DECREASE SPINDLE
 - DECREASE FLUTES
- WHY DOES INCREASED CHIP SIZE IMPROVE TOOL WEAR?
 - MORE WORK PER REVOLUTION
 - LESS HEAT

ACHIEVING MAXIMUM FEED RATES

- **MATERIAL CONSISTENCY**
 - Are materials multi-sourced or from a single vendor?
 - Do the wood laminates vary?
 - Different colors of the same plastic can machine very differently?
 - Is the aluminum or plastic sheet stock flat or warped?
 - Are plastic thermoformed parts of a consistent temperature?
- **OPERATOR SKILLS AND ABILITY**
 - Willingness to change methods of procedure, programming, fixturing.
 - Accountability to adequately measure tool life and edge finish.
 - If the tool life increase by 25% or the edge finish improves by 15 pinches, do they know it? More importantly, do you know it?
 - Willingness and/or incentive to feed more parts across the machine to gain throughout.
- **CONDITION OF THE MACHINE**
 - Minimal Spindle Runout (Do you ever check this?)
 - Clean collets, collet nuts, tool holders, spindle taper.
 - Good dust collection. Can you clear gummy chips?
 - Servos and controller. Can the machine maintain high feed rates in a tight radius?
- **FIXTURING**
 - Must have the ability to hold parts ROCK SOLID
 - Properly made spoilboards that allow consistent part holding raised spoilboards that allow non-stop multi-pass machining.
 - Minimize unsupported edges during 5-axis machining.

CHIPLOAD

CHIPLOAD = THICKNESS OF CHIP REMOVED

$$\text{CHIPLOAD} = \frac{\text{FEED RATE}}{\text{RPM} \times \text{FLUTES}}$$

CHIPLOAD

TO INCREASE CHIPLOAD:

- Increase FEED RATE
- Decrease RPM
- Use less FLUTES

TO DECREASE CHIPLOAD:

- Decrease FEED RATE
- Increase RPM
- Use more FLUTES

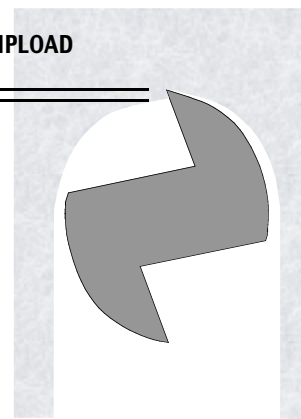

(i.e. two flutes provides two chips equal to one half the amount of travel in one revolution) Regardless, it is extremely important to produce chips of adequate thickness, not dust, fines, or slivers.

Most of the energy expended during these actions is released as heat. Heat is one of the major factors in tool wear. The most effective way to reduce the heat is to have it removed with the chip. This can be accomplished by cutting the correct size of chips which will both dissipate heat as well as yield a high quality part edge finish due to minimization of re-cut chips. This is only possible when a tool possesses the proper geometry allowing for optimization of both speed and finish characteristics. Onsrud Cutter provides a complete guide to tool selection in their catalog as well as the two websites (www.onsrud.com and www.plasticrouting.com). These sources also provide information on recommended feeds and speeds for a variety of materials.

Another indication of proper speed and feeds is the tool temperature. As a standard procedure, run a "Cool Tool Test" by running a nest of parts and checking the temperature of the tool after the spindles stop rotating. If a proper speed and feed is utilized, the tool should be at or near room temperature. Remember, **heat** is what breaks down the cutting edge of the tool.

When chipload is inadequate, the first change is to adjust the feed speed. This is the controlling factor in productivity. If the feed rate is maximized due to part configuration, hold down capabilities, software limits, or machine limitations, then the spindle speed should be lowered. This does two things; 1) it increases the chip thickness and 2) it lowers the number of times the cutting edge is presented to the material. The second factor can be a major factor in increased tool life. This could increase tool life by 15 to 20%. It also reduces the spindle bearing temperatures by reducing heat transmitted into the spindle.

In the final analysis, the entire process of maximizing feeds and speeds extends tool life and reduces part cost by significantly lowering cycle times.

HEAT AND TOOL WEAR

- **FACT:**
 - Heat accelerates chemical reactions?
- **FACT:**
 - Hot corrosion is frequently the leading cause of tool wear?
- **FACT:**
 - Hot corrosion is a chemical reaction between Cobalt and the Material being machined?
- **RESULT:**
 - Less heat slows hot corrosion which reduces tool wear.

ADDITIONAL METHODS OF HEAT REDUCTION

- **AVOID DEAD STOPS:**
 - SE Tools contact a part 300 times/sec?
 - DE Tools contact a part 600 times/sec?
 - 3E Tools contact a part 900 times/sec?
- **PLUNGING:**
 - Get in and start making chips?
- **COOLANT:**
 - Water
 - Air
 - Ramped Plunging into the workpiece
 - Higher Plunge Speeds

CNC FEED & SPEEDS FORMULAS

$$\text{Chip Load (Inches)} = \frac{\text{Feed Rate (IPM)}}{\text{RPM} \times \text{No. Of Flutes}}$$

$$\text{Spindle Speed (RPM)} = \frac{\text{Feed Rate (IPM)}}{\text{Number Of Flutes} \times \text{Chip Load}}$$

FOR TIME STUDIES AND TRUE AVERAGE CHIP LOADS USE THE FOLLOWING:

$$\text{ACTUAL FEED RATE (IPM)} = \text{INCHES ROUTED} \div \text{CUTTING TIME} \times 60$$

BIT DIAMETER ADJUSTMENTS:

$$\begin{aligned} 1/4'' \text{ CED} &= \text{CHART FEED} \times .6 & 5/8'' \text{ CED} &= \text{CHART FEED} \times 1.2 \\ 3/8'' \text{ CED} &= \text{CHART FEED} \times .8 & 3/4'' \text{ CED} &= \text{CHART FEED} \times 1.4 \end{aligned}$$

DEPTH OF CUT ADJUSTMENTS BASED ON CUTTING EDGE DIAMETER

3/8" AND BELOW SIZES:

Normal Depth Of Cut = 2 x Cutting Edge Diameter
Feed Rate = .75 x Value Found In Bit Diameter Adjustments

Always remember make chips not dust!

REDUCING HEAT

- FACT:** AS CHIP SIZE INCREASES, THE VOLUME/(SURFACE AREA) RATIO INCREASES.
- FACT:** THE LARGER THAT RATIO, THE MORE HEAT A CHIP CAN STORE
- FACT:** AS CHIPS ARE EJECTED, THEY CARRY AND RETAINED HEAT WITH THEM.
- RESULTS:** LARGER CHIPS CARRY MORE HEAT FROM THE CUT AND DO NOT ALLOW IT TO BE TRANSFERRED TO THE CUTTER.

TYPICAL FEED RATES IN WOOD

- **1/4" CED - 1/4" DEPTH OF CUT:**
 - Wood Routs: 150ipm to 300ipm
 - Finishers: 150ipm to 250ipm
- **1/2" CED - 1/2" DEPTH OF CUT:**
 - Wood Routs: 200ipm to 400ipm
 - Chipbreaker/Finishers: 350ipm to 1200ipm
 - Roughers/Hoggers: 500ipm to 1500ipm
 - Compression Spirals: 400ipm to 1500ipm
 - Finishers: 200ipm to 600ipm

ALL FEED RATES BASED ON 18,000RPM SPINDLE SPEED

TYPICAL FEED RATES IN PLASTICS

- **1/4" CED - 1/4" DEPTH OF CUT:**
 - Acrylics 125ipm to 250ipm
 - Polypropylene: 150ipm to 300ipm
 - Polyethylene or HDPE: 150ipm to 300ipm
 - Polycarbonate: 100ipm to 200ipm
- **1/2" CED - 1/2" DEPTH OF CUT:**
 - Acrylics 150ipm to 300ipm
 - Polypropylene: 150ipm to 400ipm
 - Polyethylene or HDPE: 200ipm to 500ipm
 - Polycarbonate: 100ipm to 250ipm

ALL FEED RATES BASED ON 18,000RPM SPINDLE SPEED

TYPICAL FEED RATES IN ALUMINUM

- **1/8" CED - .060" DEPTH OF CUT (Single Sheet):**
 - SC Spiral "O" Flutes: 150ipm to 300ipm
 - SC Standard Spirals: 60ipm to 125ipm
 - HSS Standard Spirals: 45ipm to 90ipm
- **1/4" CED - .25" DEPTH OF CUT (Stacked Sheet or Plate):**
 - SC Spiral "O" Flutes: 125ipm to 250ipm
 - SC Standard Spirals: 90ipm to 175ipm
 - HSS Standard Spirals: 75ipm to 150ipm
 - Stacked sheet will typically feed faster than plate*

ALL FEED RATES BASED ON 18,000RPM SPINDLE SPEED AND MIST COOLANT CONDITIONS

1/2" AND ABOVE SIZES:

Normal Depth Of Cut = 3 x Cutting Edge Diameter
Feed Rate = Full Chart Values
Feed Single Flutes Slightly Faster x 1.1

COLLETING AND MAINTENANCE

Many users select tools without regard to the importance of adequately holding them in the colleting system of the router. This is often the case in routers ranging from simple air routers to the most complex CNC machines. All collets are of two basic types; half grip or full grip. The attributes and peculiarities are important because of the way in which they secure the tool. We like to think of the spindle/collet system as a chain. Just as a chain is only as strong as its weakest link, so is the collet in relation to the tool. A high performance tool can only perform when the collet is properly maintained every time that the tool is changed.

TYPES OF COLLETS

There are two basic types of collets, namely half grip and full grip. Both types are not always available with every spindle.

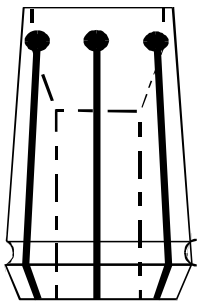

HALF GRIP COLLET

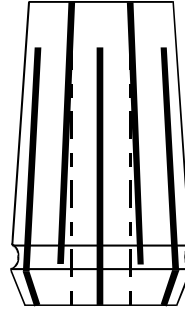
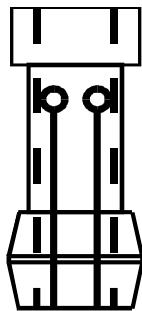

FULL GRIP COLLET

HALF GRIP COLLETS

Half grip collets are identified by slits running from the bottom or mouth of the collet toward the top for about 80% of the collet length. This allows them to squeeze the tool with a force primarily directed at the mouth or bottom of the collet. These collets are often counterbored at the top and the shank of the tool is not allowed to contact the entire length of the collet. This type of collet is the simpler of the two types and is ideal where tools do not have a long enough shank to fill the entire collet.

FULL GRIP COLLETS

Full grip collets are identified by slits running from both ends, which create specific collet sections. This full grip type allows squeezing over the entire length of the collet. Proper utilization requires the tool to fill a minimum of 80% of the depth of the collet. This type of collet tends to have more flexibility and *often* comes in what is termed as "Range Collets". These allow gripping a range of shank sizes. Example: 12-13 mm is used for 1/2" shank tools. This increase in gripping range can have a price in longevity of the collets. They are required to collapse more each time onto the tool thereby making the memory of the collet very important. Often times the memory goes away much faster than an inch size collet. Another more annoying habit of range collets is their inability to snugly hold onto the tool while it is not yet tightened down. Often when these collets are used they will drop the tools onto the table causing potential damage. Consequently, specific size collets are recommended for relative size shanks. (Even metric collets should be specific).

The most important portion of the collet is the mouth, which is located on the bottom end from where the tool extends. This area is important because all the lateral pressure taken by the tool must be evenly distributed on all sections of the collet for it to cut true or concentric. It is very critical that the 80% rule (at least 80% of the collet filled with tool shank) be followed when using a full grip collet due to the ability of the collet to flare at the top. Not colleting at the 80% level will allow tool movement in very minute amounts resulting in tool breakage. There are times that the 80% rule is not possible because of inadequate shank lengths. It then becomes necessary to fill this void in the top of the collet with a filler or collet life plug the same size as the shank. This is a practical way to solve the problems of short shanks and collapsing of the collet which may occur by not following the 80% rule.

Equally as important is overcolleting. This occurs when the "flute fadeout" portion of the tool is allowed to extend inside the collet. This does not allow a firm equal grip by all sections of the collet at the mouth. This uneven support at the most critical area actually scars the inside of the collet. This causes permanent damage and is a common cause for tool breakage. It is necessary to visually inspect the collets for wear each time a tool is changed. Proper action will aid in avoiding tool breakage, which often results in permanent damage to the collet due to intense pressures exerted from either "burring" or "mushrooming" the mouth of the collet.

PROPER TOOL COLLETING

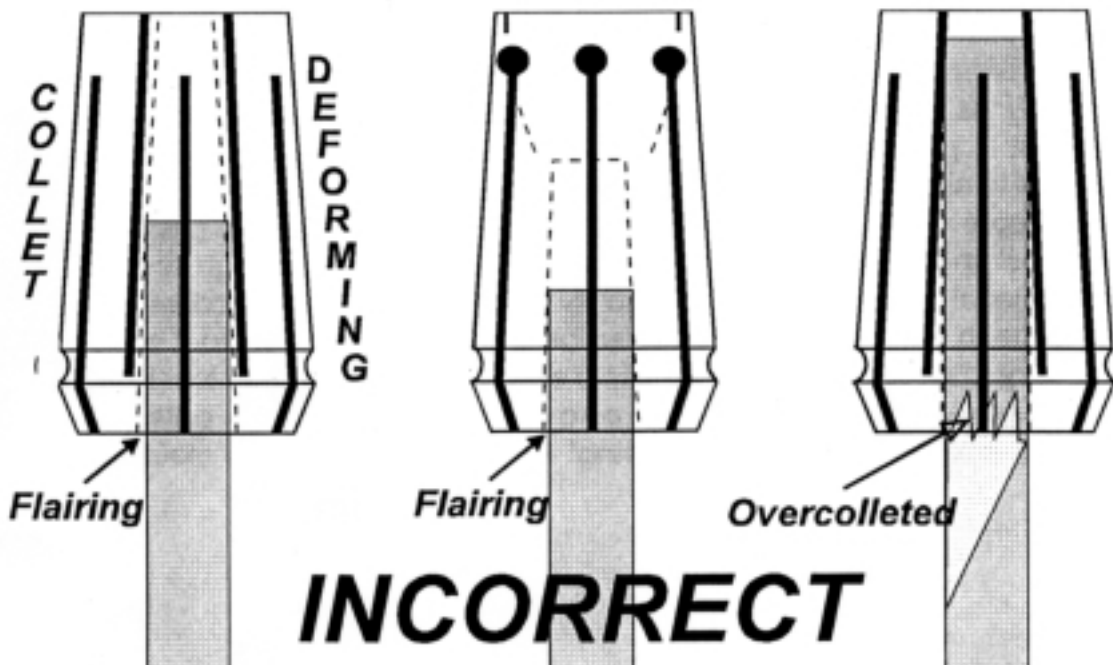
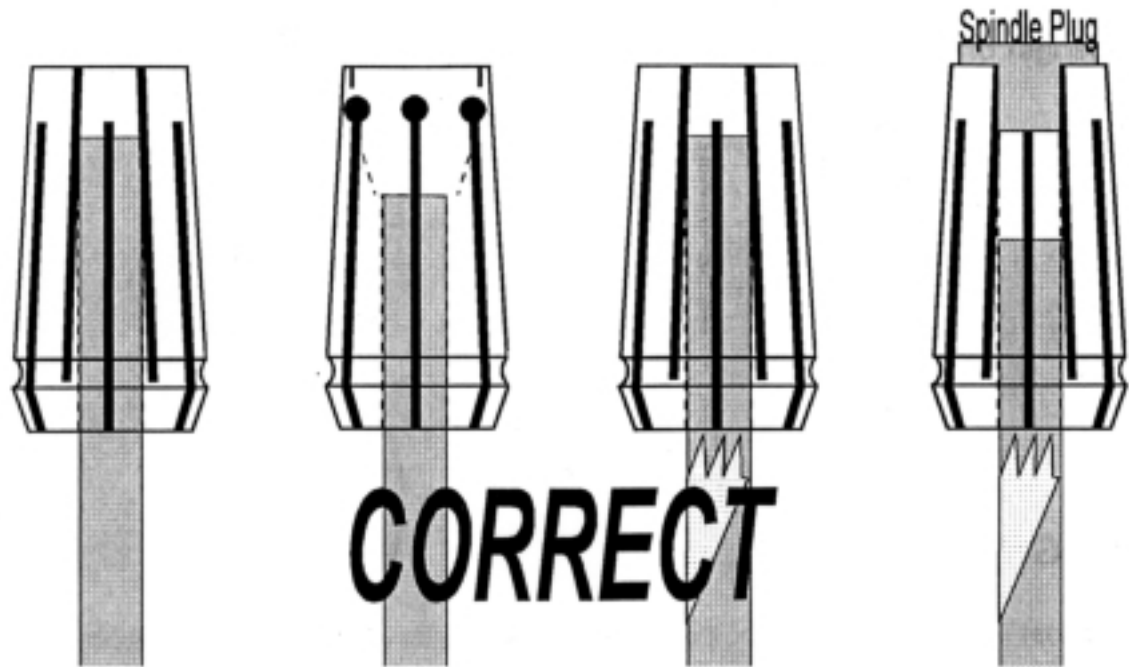

TYPES OF COLLET NUTS

There are two spindle or collet nut styles prevalent in the industry. They include the solid nut and the bearing style nut. Both types are not always available depending on the spindle.

Bearing type nuts contain a thrust bearing allowing the collet to be tightened without the friction that normally is present when the spindle nut is tightened directly onto the collet.

Solid nuts are tightened directly onto the spindle and often require greater tightening pressure than bearing type. The force required to tighten them can sometimes be reduced with use of dry graphite film. But petroleum based lubricants should be avoided due to their ability to act as a magnet for any dirt or dust.

A new style or process is the coated solid nut with special heat treating and coating properties which provide up to 100% more clamping pressure. The coating negates the need for a thrust bearing.

COLLET MAINTENANCE

Heat is the biggest enemy of the tool and the initial transfer of heat is from the tool to the collet. Collets are manufactured from spring steel and over a period of time, heat and usage causes them to lose elasticity. This hardening process makes tightening of the collet more difficult thus causing uneven gripping and ultimately tool runout.

It is important to understand when hardened collets are not replaced; over tightening will eventually damage the internal spindle taper resulting in costly repairs. This process occurs gradually over a period of time and is difficult to diagnose. A practical recommendation for collet life is in the 400-600 run time hours. This is about 3 months in a normal two-shift operation. If collets are not changed, they will eventually become brittle enough to crack or break and permanently damage the spindle. Preventative maintenance is much cheaper than this costly alternative. Timely collet replacement is important, but cleaning the collet, along with the collet nut, toolholder taper, and inside spindle taper each time the tools are changed is equally important. Collets are in a dirty environment and are expected to perform a very accurate task while subjected to extreme heat. As material is routed, whether it be wood, plastic, aluminum, or man-made board, the chips carry many resins migrating up the slits in the collet and depositing onto the inside of the collet ears (usually nearest the mouth of the collet). The resin acts as pressure points gripping the tool tighter at the mouth of the collet. These pressure points often distort the grip on the tool creating runout. This resin heats up as the tool does and actually transfers onto the shank of the tool almost adhering the tool into the collet. Many times the tell tale sign of this transfer is brown marks at the mouth of the collet contact on the shank. These marks are a strong signal of collet neglect and the necessity to institute a collet maintenance procedure.

To prevent this problem, the resin must be removed from all surfaces using a non-abrasive brass tube brush to clean inside of the collet in combination with a cleaner such as Rust-Free. This nonflammable, biodegradable cleaner allows it to be safely used on the shop floor. This cleaner will also do an excellent job of removing the "fretting" resin build up that occurs at the base of the ISO 30 toolholder taper along with a light scrubbing with the brass brush. Make sure that all surfaces including outside and inside collet and inside spindle taper are thoroughly clean and dry before reassembling. If ISO 30 quick-change toolholders are used, make sure to clean all matching and mating surfaces as well. Also, the collet nut should be cleaned of resin and chip buildup and regularly replaced to insure the integrity of the whole collet system. Do not allow Rust-Free to soak on any surface for longer than 5 minutes. It is important to point out that simply blowing out the collets or soaking them overnight in a thinner does not rid collets of resin buildup. In fact, the later procedure can prove to be hazardous. Do not use a petroleum-based lubricant for cleaning, as it will only act as a magnet for all of the dirt and dust by the residue it leaves behind. The Onsrud Cutter catalog provides availability of brass collet brushes, spindle taper wipes, Rust-Free, and a waterproof lubricant called Boeshield T-9 for protecting parts from rust and corrosion.

COLLET EXAMPLES

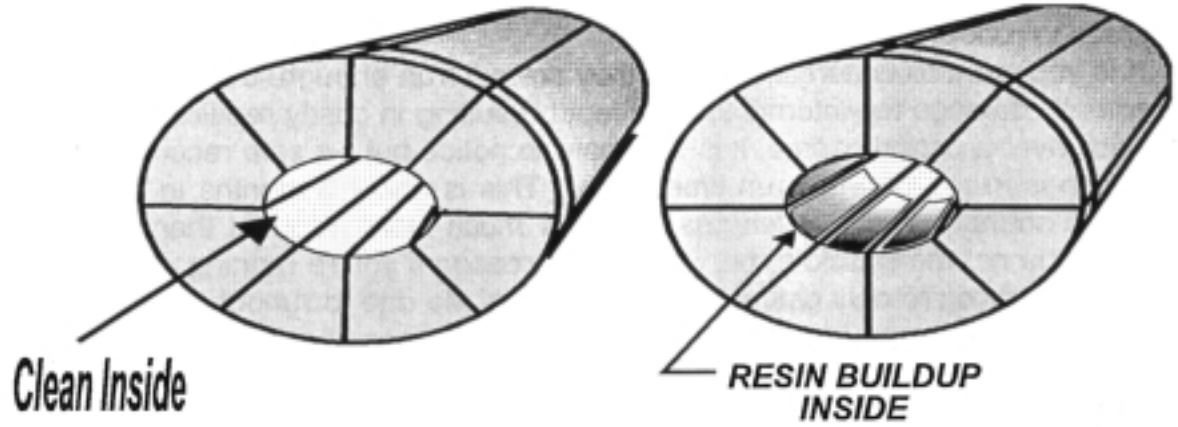

SPINDLE TYPES

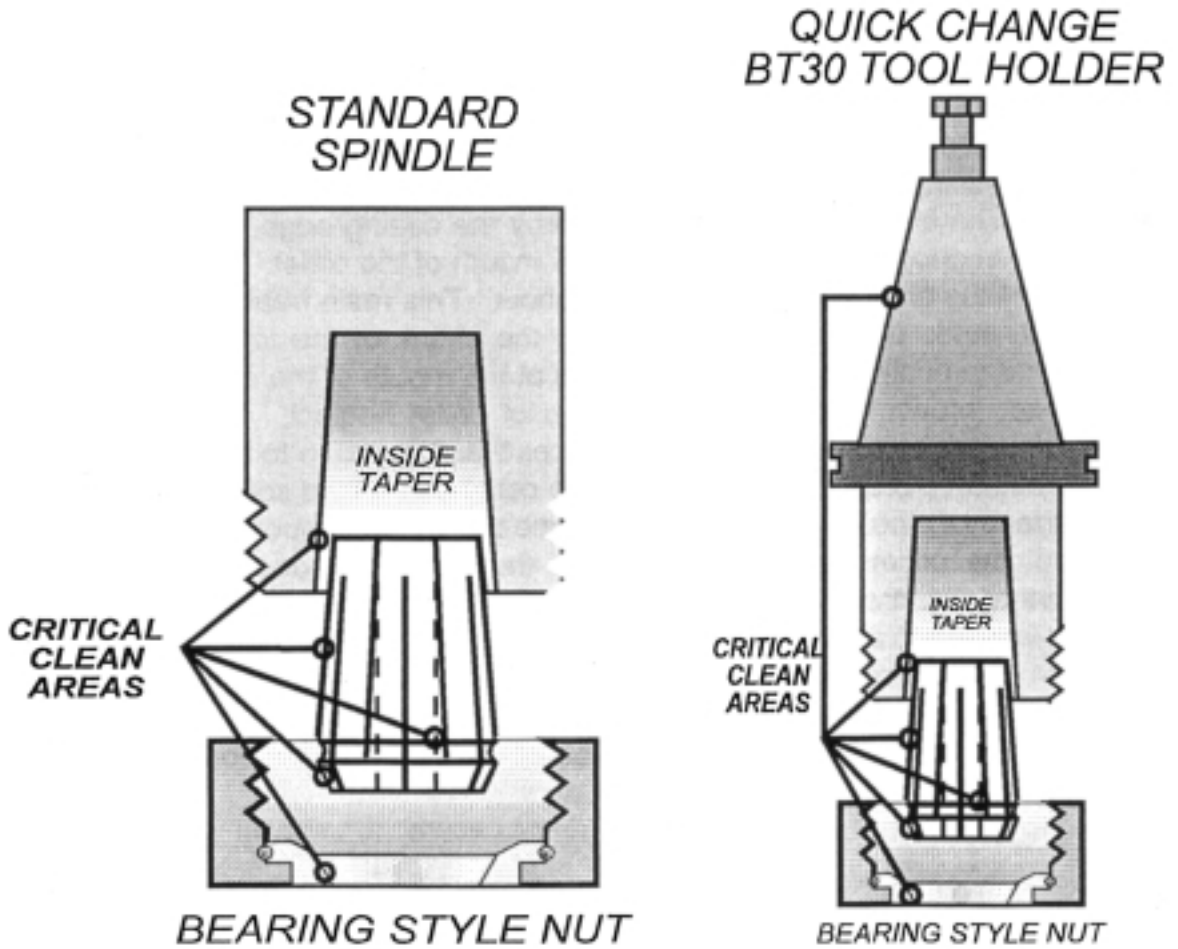

FIXTURING/SPOILBOARD TECHNIQUES

Many times CNC routers are set up almost perfectly with the right tools, elaborate vacuum systems, and somehow the method of holding parts on the table receives little attention as the key element in the operation. If there is anything that can really enhance the success of an application, it is the ability, to *properly* hold a part during the machining operation. There are many machines utilizing dedicated spoilboards to hold parts. The proper way to build a dedicated spoilboard is often misunderstood or cut short in the interest of time to construct them. Investing the time to do it correctly will pay dividends in the form of productivity. Many consider a spoilboard as an adequate fixture if it is just a piece of MDF or particleboard with self-stick weather-stripping and a few holes drilled inside the perimeter. While this type of fixture has worked a long time for many people, it does not often satisfy the demands made in high performance routing. If the router is going to run at production speed, the parts have to stay on the table or the tools are going to break!

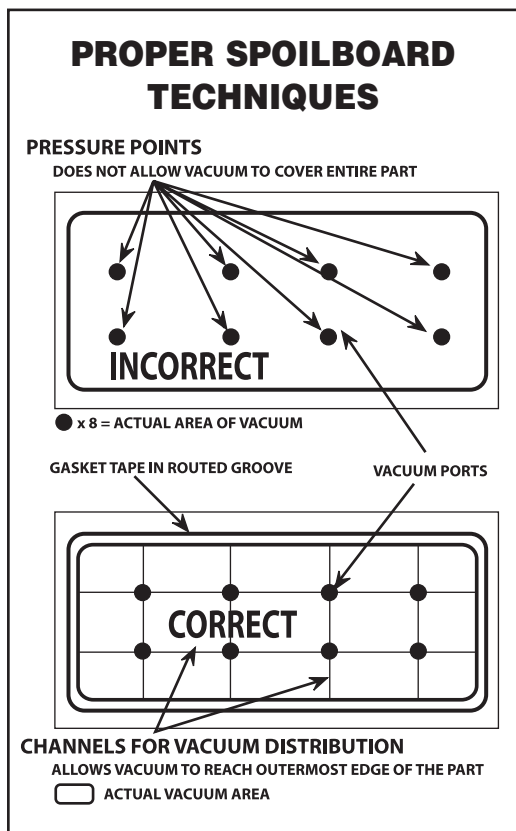

DEDICATED SPOILBOARDS

There are many problems associated with this shortcut method. First, as the workpiece is suspended on the tape above the spoilboard, the part may vibrate causing holding problems, poor part finish, and tool breakage. The use of weather-stripping is totally inadequate.

Weather-stripping is an open cell construction and after a short period of time, the tape will collapse and limit the gasket's effectiveness, especially with slightly warped parts. A quality closed cell gasket tape must be utilized to properly build a dedicated spoilboard. Closed cell does have a "memory" capability and is really important to avoid vacuum leaks and subsequent part movement. Some end-users go a step further by routing a groove to receive the vacuum tape. While this may allow the workpiece to contact the spoilboard, it also closes off the vacuum holes limiting the vacuum only to the area of these holes.

Better production techniques include routing a channel to receive the gasket and grooving the interior area of the gasket perimeter. The channel for the gasket tape is typically 1/2 of the thickness of the gasket tape. This allows the tape to be above of the spoilboard initially to assist in creating the seal on the workpiece. When the vacuum is applied, the gasket tape is forced into the channel allowing the workpiece to make contact with the "plate" of the table which provides better part registration and better part holding. Grooving or sectional pocketing of the interior area of the gasket perimeter allows the vacuum to reach the

outermost portion of the part. This also allows a greater vacuum surface area. Without grooving, the interior of the vacuum area is equal to the area of the diameter of the holes once the part is vacuumed down onto the table. Now with the part contacting the "platen" providing surface adhesion and the vacuum area distributed throughout the part, you have the best chance to secure the part at production routing speeds. The workpiece contacting the "platen" is especially valuable when skin or tab cutting because of the consistent part registration.

Additional measures should be taken to seal the spoilboard material if porous material like MDF is used. By sealing the spoilboard, you minimize the chance of leakage and direct all available vacuum to holding the workpiece. Sealers such as polyurethane, sanding sealer, and rubberized coatings should be applied after the channeling and grooving is complete. Sealing the spoilboard will also help stabilize the spoilboard so that it will remain flat throughout its life.

RAISED SPOILBOARDS

Raised spoilboards are another type of fixturing that works quite well for routing parts such as circles from squares where the scrap or off-fall is of such a size to be potentially harmful to the tool and the operator when it is cut free. This is often encountered in parts where a two-pass operation is performed. Such is the case with a bar stool top where a first pass would rough out the part with a chipbreaker tool and a final pass would be taken with a 3-edge finisher or a shape tool if a shaped edge is required. A raised spoilboard would make sure that the off-fall would not interfere with the first or the second tool and that the off-fall would be free and clear of the tool path.

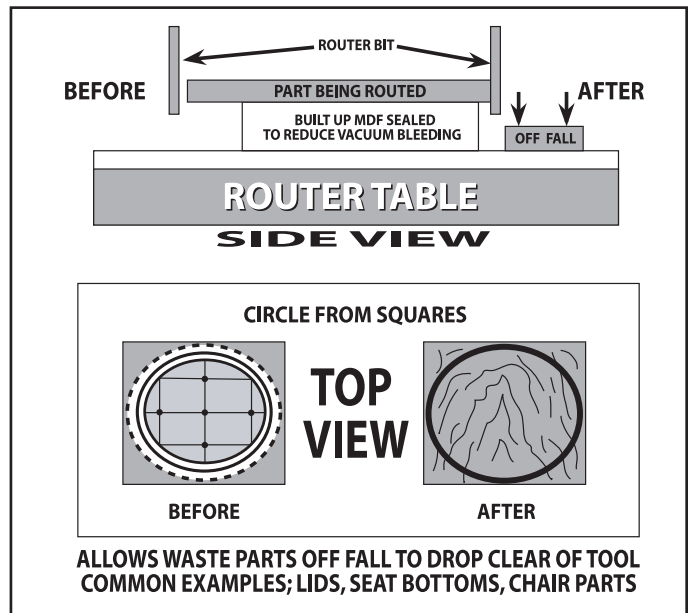

FLOW THROUGH VACUUM

Flow through, which is also referred to as high volume or suck through, is another technique gaining in popularity due to minimal set-up time. This method relies on LDF (Low Density Fiberboard) or MDF (Medium Density Fiberboard) porous enough to allow a large vacuum pump of 16-40 HP to actually draw through the board. This method is not effective on all machines due to special design of the vacuum plenum that distributes the volume throughout the surface of the table. This method is popular with cabinet and store fixture operations where short run parts of sheet goods materials are common. It is also used for sheet plastics machining. And lastly, it has become the staple operation of the upholstered furniture manufacturers and boat manufacturers allowing numerous parts to be cut and up to 80% yields from single sheets of plywood. This method can be successfully employed but can be problematic with small parts. Consequently, the cutting of wood parts utilize downcut spirals to intentionally pack the chips into the cut and minimize vacuum loss through the open table area created by routing. This strategy sustains more heat in the tool but allows the packed chips to minimize movement by acting as space fillers until the cutting cycle is completed. Many times smaller diameter tools such as 3/8" and 1/4" will allow reduction of open table, as well as minimized cutting pressure. For example, the open table and lateral pressure from a 1/2" tool is reduced by 25% when 3/8" tools are used. Additional methods of reducing part movement when dealing with small parts in a flow through operation is tab and skin cutting which will be further explained later in the Programming Techniques section. Basically in both processes a portion of the original material is left to aid in holding the parts together.

When cutting parts using the flow through method, it is best to surface the top and bottom of the board with a large diameter spoilboard surfacing tool. This allows for increased porosity as well as equal registration over the entire surface area of the table. The resurfacing not only levels the board, but also eliminates the routing grooves made during the process of machining parts. The more the board is surfaced the better the porosity and flow, which is essential in this type of spoilboard. Onsrud Cutter offers Spoilboard Surfacing Cutters (series90-000) for resurfacing the table at very high feed rates covering a large 2-1/2" to 4" area in each pass. These tools utilize indexable inserts that allow the tools to be easily renewed by turning the inserts. Finally, increased vacuum power to the work area can be attained by taping the edge of the spoilboard, sealing the edge with rubberized paint, and covering unused areas with scrap or thin plastic sheet. This aids in minimizing leakage, which is the enemy of the flow through system that thrives off high volume of vacuum.

SURFACING SPOILBOARDS

• REASONS

Humidity swells MDF making it difficult to machine thin sheet stock. Warped surfaces reduce holding pressure when using vacuum. Unable to tab or skin cut parts on a warped table

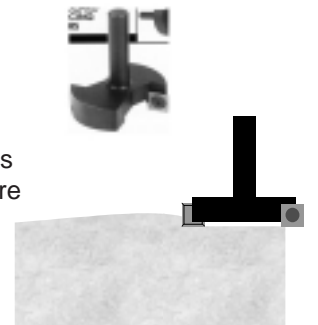

OTHER TYPES OF HOLDDOWN SYSTEMS

Within the realm of vacuum systems a fixturing process that is sometimes seen is the Pod System which utilizes a raised approach to alleviate the aforementioned problems with off-fall. Also, this system allows the operator to change the configuration of the part setup by flipping pods on top or underneath the work area to accommodate the travel of the cutter and duplicate the desired pattern. The system is somewhat limited in terms of vacuum area and almost always necessitates the use of downcut or neutral effect tools to avoid pushing parts off the pod. These systems are commercially available, but some firms have manufactured homemade versions to accommodate individual needs and save cost. The Pod System is extremely prevalent in Point-to-Point machines.

In the area of mechanical holddown, the Roller Holddown is probably the most predominately utilized in conjunction with CNC routing. This mechanism has rollers, which travel the length of the work area holding down specific areas as the individual part is machined. It may be assisted with flow through vacuum, but most times the roller holddown is the sole agent to eliminate part movement. This type of machine and holddown procedure is very prevalent in the manufacturing of upholstered furniture and boat parts.

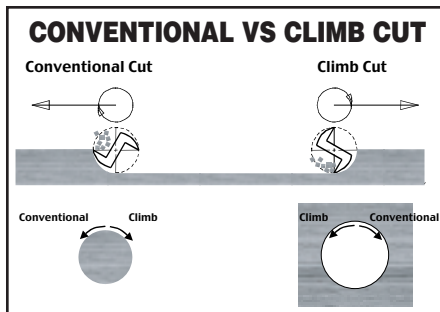
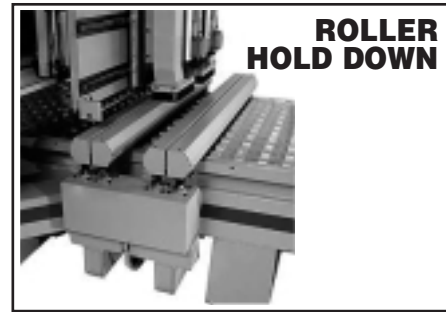
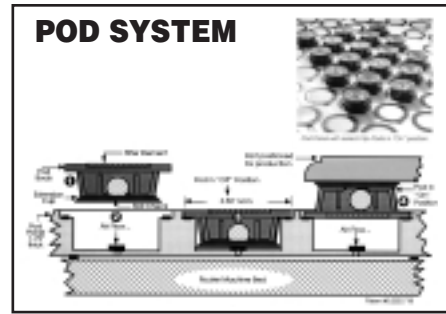

PROGRAMMING TECHNIQUES

CLIMB AND CONVENTIONAL CUTTING

In most cases, conventional cutting provides the best edge provided the right tool geometry to cut a specific material has been selected. This applies mainly to man-made board products. If you are cutting solid wood where multidirectional grain patterns have to be considered, it is often necessary to employ climb cutting thereby limiting the chip the tool can remove at one time and reducing splintering.

In CNC routing with right hand rotation tooling, climb cutting occurs as the perimeter of the workpiece is routed in a clockwise direction. Routing the same workpiece in a counter clockwise direction represents conventional cutting. The whole process is reversed when making internal cuts on the part. When workpiece finish is substandard, check the scrap as a comparison. If the scrap finish is better, change the direction of feed.

OSCILLATING TO IMPROVE TOOL LIFE

When cutting laminated materials such as plywood, laminated MDF or particleboard with a decorative surface such as melamine, glue lines represent the biggest threat to tool life. These glue lines are more abrasive than the surrounding material and tend to cause focused wear at a single point on the tool thereby prematurely degrading one or more of the areas of the edge. The remedy for this situation, provided a dedicated spoilboards or a pod system is in use, is to ramp the tool up and down through each tangent of the part insuring the glue line is never focused on one spot of the tool for any length of time. This will increase the life of the tool substantially while not actually reducing cycle times. The method of dropping the "Z" axis when the tool starts to get dull is highly ineffective. By the time you realize the edge is chipped, it is already too late to recalibrate the "Z" axis and the tool will leave lines in subsequent parts. Note that some software manufacturers offer the preferred approach in the form of "automatic tool oscillation".

SKIN CUTTING PARTS

Skin cutting is a method of cutting parts where the tool cuts most of the way through the part leaving a thin "skin" attached to the larger sheet. Typically skin thickness is .020 - .030" requiring that the spoilboard must be surfaced flat before machining parts. This method is commonly employed in small parts that cannot adequately be held individually by vacuum. Such is the case with lettering or narrow parts where gasketing is impossible. This method also allows for faster loading and unloading of the machine as parts come off in the same quantity as went on the machine. This method is often employed in solid wood where after the parts come off the router they are passed through a wide belt sander to remove the "skin" and sand the parts free. Sometimes the parts are just broken apart and then routed on a table router with a flush trim bit or sanded to eliminate the skin. On some high accuracy routers routing plastic sheet on properly surfaced spoilboards, the skin may be limited to only the masking.

TAB CUTTING PARTS

Tab or bridge cutting is another method similar to skin cutting. The material is cut through; however, tabbing leaves a skeletal framing behind to hold the parts together. This is commonly used where many parts are cut from the same sheet of material while almost the entire table is opened up on a flow through vacuum system thereby minimizing holding power. The tabbing allows the skeleton to hold everything together until the cutting is completed. Tabbing usually leaves behind a 1/4 – 1/2" long x .020" thick tab, which can either be routed away in a final pass or sanded or trimmed away in a secondary operation.

ROUGHING AND FINISHING

The propensity of tool changers on CNC routers has made the concept of roughing and finishing passes a productive technique to improve edge finish and part quality without sacrificing productivity. In this process, a rougher is used to remove the bulk of the material leaving and a finisher or profile tool is employed to achieve the finished edge. The material remaining for the execution of the finish pass should be approximately 20% of the diameter of the tool used in the roughing portion of the application. In both roughing and finishing, the feed and speed should be appropriate to enhance productivity without adversely effecting the part.

MIRRORED OR NESTED PARTS

If possible, always attempt to make the tool run the edges of both parts in one pass. This is a shared cut, which means one edge is climb cut and the other is conventional cut. This works extremely well for parts not requiring a high quality edge finish such as plywood panels for upholstered furniture industry. However, users should be careful not to utilize mirroring techniques when cutting circles. The climb cutting of one part followed by the conventional cut of the next part requiring a high quality finish will result in two different edge finishes. This happens frequently with point-to-point machines where parts are repeatedly run on either end of the machine. It is much more practical to "copy" the program in order to achieve similar part finish. Failure to maintain proper direction of cut will result in not only reduced edge quality but diminished feed rates and tool life as well.

AVOID DEAD STOPS

A router bit in a CNC environment was designed to run at high performance feeds and speeds. Unfortunately, parts many times have corners, which necessitates the router bit to slow down or stop to change direction. Understanding the concept of chipload, it is easy to comprehend the devastating effect this has on the cutting edge of the tool. In other words, nothing good happens when the tool stops. Consequently, it is important to establish corner-rounding techniques that minimize the adverse condition created by stopping in the cut. There are two ways to alleviate or lessen the severity of corner rounding. First, a very small radius of .001 applied on the corners will prevent dead stops, but at a very reduced feed rate. The most effective method is to do a looped corner where the tool travels beyond the corner and loops back and intersects the original path. This provides a cooling effect on the tool as it momentarily leaves the workpiece and assures a square corner.

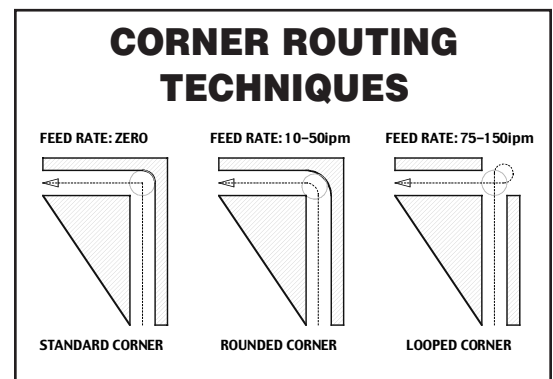
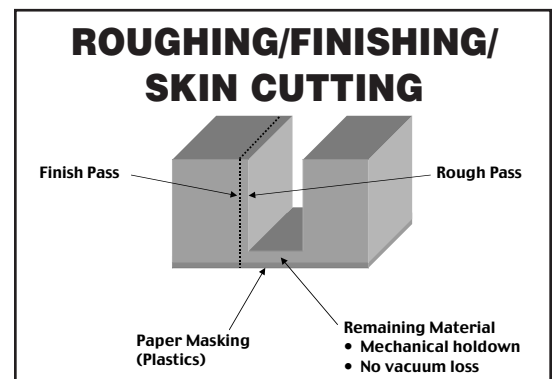
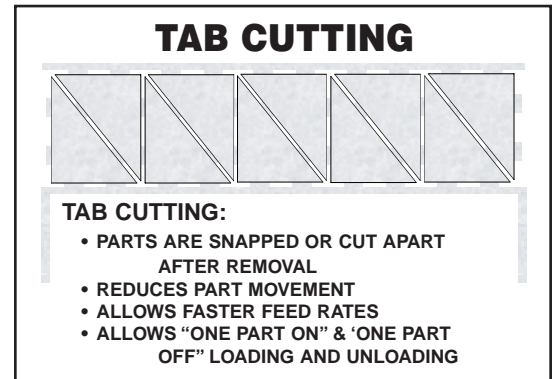

TOOL SELECTION

Tool selection involves an evaluation of the circumstances regarding the application and asking questions or making a needs assessment. The needs assessment is the logical order to follow in making a valid tool selection.

WHAT TYPE OF MATERIAL IS BEING MACHINED?

This is the first and most basic question because it defines the type of tool material and geometry needed to perform the job. In terms of wood, some are natural woods; others are man-made composites or combinations of both. Plastic and aluminum have characteristics of hardness and softness, which dictates tool material and geometry. Consequently, the foremost question becomes how is the part material going to effect the tool material and the life of the tool?

WHAT TYPE OF ROUTER IS BEING UTILIZED?

The use of a hand router or pin router dictates different tool choices than a CNC machine. The obvious difference is feed and speed capabilities and how various tool materials react in the cutting environment. Hand fed operations tend to be best suited to steel bodied router tools, which can better tolerate inconsistent feeds, while CNC machines enhance the toughness of solid carbide.

WHAT IS THE MATERIAL THICKNESS?

Quite simply, this question leads to the selection of tool diameter and cutting edge length. Always choose the tool with the shortest possible cutting edge to cover the thickness of the part with a slight overlap. Since diameter of tool increases rigidity, it is best to select the largest diameter possible, but the cutting edge length should be as short as possible and not more than three times the diameter in a perfect world.

WHAT IS THE PART CONFIGURATION?

The size, contour and detail in a part play a huge role in tool selection and tool life. For instance, large parts can be machined extremely fast and may react very well with multi-flute tools. Conversely, a smaller part with tight radii would operate ineffectively with multi-flute tools by decreasing tool life because of slower feed and speed.

HOW IS THE PART BEING HELD?

In the section regarding vacuum systems and holddowns, the emphasis was on rigidity of part during the routing process. Tool selection is almost a mute issue if the part is not held solidly.

WHAT INFLUENCE SHOULD THE TOOL HAVE ON THE PART?

Router tools come in straight, shear, spiral upcut, spiral downcut, and a combination of up and down cut. They come in single flute through multi-flute in a wide range of diameters. All these characteristics have an influence on the part. For example, in a thermoformed part which is set up on a formed fixture, it is important to have no or neutral influence on the part to alleviate problems of pulling the part off the fixture. The larger diameter tools exert more lateral pressure on a part; smaller diameters do the opposite but provide less chip removal because of smaller flute area. Spirals move chips up or down and influence the part in the same direction. Influencing the part by tool selection is important and must be considered when selecting the right tool.

WHAT IS THE MOST IMPORTANT CONSIDERATION, SPEED OR FINISH?

The selection on feeds and speeds specifically details the theory behind chiploads and tool life. Once the right tool for a job is chosen, the tool life is really a function of how the end-user fixtures the part and the speed and feed rate applied to the part. If chips are produced a significant thickness to dissipate heat, then tool life will be extended.

In summary, following these basic principles will aid in the tool selection process:

- Match the tool with material and the application
- Select a tool with the shortest cutting edge length to cut through the part
- Select the largest diameter possible to achieve rigidity
- Keep cutting and shank diameter the same whenever possible
- Select tools that accomplish goal i.e. finish or speed
- Select tools on the way the part needs to be influenced
- Select multi-function tools i.e. compression spiral with mortise point
- Select tools based on productivity rather than cost (The final bullet point is best illustrated by the Value Analysis Report on the next page)

ROUTER SELECTION RESOURCES

- Onsrud Cutter Production Catalog
- Internet at www.onsrud.com and www.plasticrouting.com

VALUE ANALYSIS FOR COMPETITIVE TOOLING

MATERIAL INFORMATION: HIGH PRESSURE LAMINATED CHIPCORE 1.25" X 30" X 60" DESK TOPS.

CUTTER INFORMATION:

Tool Part Number:	60-170	Competitive
Tool Description:	SC DE Compression	CT DE Straight
CED x CEL:	1/2" x 1-3/8"	1/2" x 1-1/2"
Flutes:	1	2

MACHINING INFORMATION:

Router Type:	CNC	CNC
Cut Direction:	Conventional	Conventional

TOTAL PARTS FOR JOB

500 PCS

500 PCS

COSTS

Machine Costs / hour	100 \$ / hour	100 \$ / hour
Machine Costs / minute	1.67 \$ / minute	1.67 \$ / minute
Initial Tool Price	84.85 \$	15 \$
Regrind Price	24.50 \$	6.00 \$

PART CYCLE TIME

Perimeter Inches Part	180 inches / part	180 inches / part
Depth Cuts Part	1 depth cuts / part	1 depth cuts / part
Cut Inches Part	180 total inches / part	180 total inches / part
Feed Rate	600 inches / minute	200 inches / minute
Time / Part	0.3 minutes / part	0.9 minutes / part

TOOL LIFE

Avg Parts / new edge	130 parts	56 parts
Avg Parts / regrind edge	109 parts	47 parts
# of regrinds available / tool	2 regrinds	4 regrinds
Parts produced / tool	348 parts / tool	244 parts / tool

TOOL CHANGE CYCLES

Tool Changes / Job	1 tool changes / job	2 tool changes / job
Tool Change Time	5 minutes	5 minutes
Tool Change Time / Job	5 minutes / job	10 minutes / job

MACHINE TIME COSTS

Cutting Time / Job	150 minutes / job	450 minutes / job
Machine Time / Job	155 minutes / job	460 minutes / job
Machine Cost / Job	258.33 \$ / job	766.67 \$ / job

TOOLING COSTS *

New Tools / Job	2 New Tools / Job	3 New Tools / Job
Regrinds / Job	3 Regrinds / Job	8 Regrinds / Job
Tool Cost / Job	243.20 \$ / job	93.00 \$ / job

TOTAL COST / JOB

501.53 \$ / JOB

859.67 \$ / JOB

* NOTE: Calculations assume no residual tool life after job is complete (i.e. cutter is discarded even if it has life left on it's new or re-ground edge).

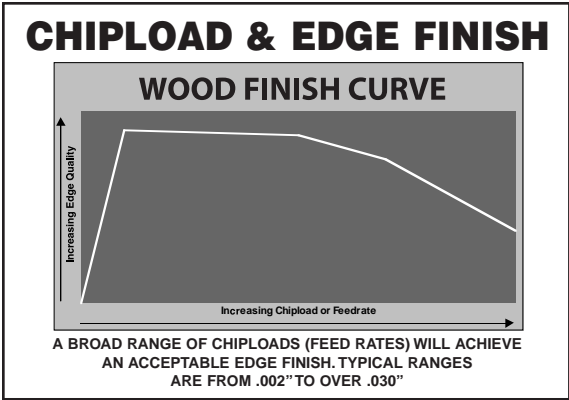

ROUTING WOOD

Wood, unlike plastic and aluminum, has a wide variance of chipload. The difference is varied because of the goal of each user. The fine furniture manufacturer has a much different concern for finish than the upholstered furniture manufacturer. The former has many exposed surfaces requiring a deeper concern for finish. While the upholstered manufacturer is concerned about some finish requirements, the bulk of product is covered with material and unexposed. Since feed rates determine chipload and subsequently finish, the range of acceptable edge finish is extremely wide in the wood industry.

In terms of types of wood, the field can be generally divided into natural wood, both hard and soft, man-made products, or wood by-products. The tooling considerations and machining techniques are different in many aspects.

Natural wood has always posed a difficult set of circumstances. As mentioned, wood may be soft or hard and geometry in the tool needs to be directed at those conditions. Basically, the rake angle is adjusted to higher angle of attack in soft than in hard wood. Wood has grain structure, which can aggravate tearout during the routing process and necessitate employing climb cutting as a technique to minimize part damage. Wood has moisture content and various natural oils, which can effect tool life.

Man-made products include MDF, particleboard, plywood, and laminate stock. Tool life problems many times occur because of glues and resins used to bind the materials. Laminated products and sometimes plywood can be problematic, not only because of glue lines but also in terms of top and bottom finish requirements. Consequently, tooling becomes an important factor in removing heat and how the direction of the chip is influenced.

Regardless of material, there are many tool selections available to promote finish and increase productivity. Once again, log on the Internet at www.onsrud.com or contact **OC On-Call at 800-234-1560**.

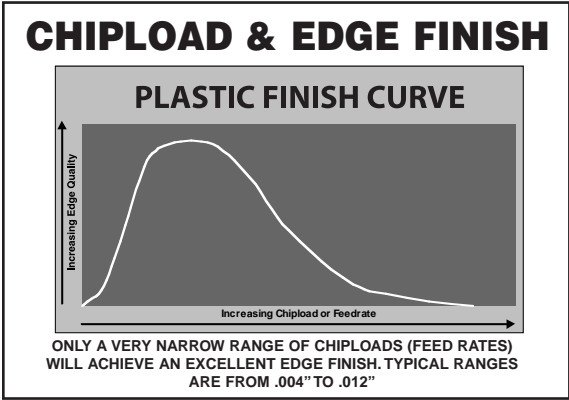

ROUTING PLASTIC

Not so many years ago, the machining of plastics was more of an art than a science. The typical sheet fabricator or vacuum former utilized a variety of innovative techniques to perform some very challenging secondary machining functions. Unique fixturing of parts and positioning of machinery to attain the necessary results was commonplace. The use of electric and air driven routers and drills was the mode of operation with cutting tool selection based on availability at the local supply house. Metal and woodworking cutting tools were utilized without regard to effectiveness or efficiency. Basically, the plastic machining industry was accomplishing a great deal without the benefit of much outside assistance.

The situation changed significantly with the advent of the CNC router in both the three-axis and five-axis mode. It became evident almost from the beginning that the method of holding parts and cutting tool selections of the past would not perform in the feed and speed environment associated with these new era machines. Plastic fabricators demanded and Onsrud Cutter responded with application specific tooling and far more information on how these tools functioned.

In initial testing and development of router tools for plastic, the key issues were chipload and edge finish and how they were interrelated. Through testing of a multitude of materials associated with the plastic industry, several factors held true. There are two basic plastic conditions recognized including soft/flexible and hard/rigid. The soft plastic curled a chip during machining while the harder plastic produced a splintered wedge, which is actually broken off during the machining process. Regardless of material type, the optimum chipload to achieve the best finish seems to be in the range of .004" to .012". As the plastic router tooling developed, it became evident that the router bits of choice for the soft/flexible material usually involved the use of an "O" flute tool. These types of material are extremely prone to leaving knife marks on the edge when adequate chiploads are not maintained. The "O" flute tools with high rake and low clearance, along with proper chiploads, aid in eliminating the knife marks by slightly rubbing the part during the machining process. The hard/rigid materials are best routed with double edge "V" flute tools. When this style of tool is utilized with the proper chipload, the cratering effect at the edge finish can be avoided. This cratering phenomenon occurs when the shear strength of the material is exceeded during the routing process.

With the aforementioned issues in mind, the correct tool is relatively simple in the initial stages. The flexible/soft plastics tend to involve the use of single or double edge "O" flutes in straight or spiral edge configurations. While hard/rigid plastic materials lean more toward double edge "V" flutes, spiral, "O" flutes with hard geometry, or two and three flute finishers. All styles are available in solid micro grain carbide to withstand the conditions of CNC routing. For specific tooling recommendations by plastic material type, log onto the Internet at www.plasticrouting.com.

SPECIALTY TOOLS FOR PLASTIC

For many years, the plastic routing industry used a variety of approaches to solve difficult applications problems. Today, Onsrud Cutter has developed a whole selection of new products to aid in the resolution of tedious application concerns.

ARBOR MOUNTED SAW BLADES

One such application involved the use of a three-axis CNC router to machine or trim formed parts. Since the router bit could only function in a three-axis mode, there was no way to adequately trim flashing from thermoformed parts without time consuming secondary operations. In order to trim these parts by cutting on the horizontal from a vertical tool position, a carbide tipped saw blade and arbor has been developed. The saw blades are available in various diameters with multi-tooth cutting action. The geometry is specific in terms of soft and hard plastic and slow and fast feedrate. The five-axis CNC router user has also embraced this tool because of the reversibility of the blade for left or right hand rotation spindles.

FORMATION OF EDGE FINISH

- BEST EDGE FINISH IS FORMED THROUGH THE CONTINUOUS GENERATION OF PROPERLY SIZED CHIPS (THOUGH THEY MAY BREAK INTO SMALLER CHIPS AFTER REMOVAL)
- CORRECT CHIPLOAD MUST BE MAINTAINED WITHIN A NARROW RANGE
- INCORRECT CHIPLOAD CAN RESULT IN CRATERING

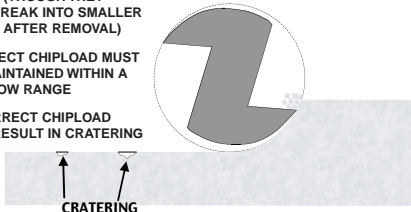

FORMATION OF EDGE FINISH

- BEST EDGE FINISH IS FORMED THROUGH THE CONTINUOUS GENERATION OF PROPERLY SIZED CURLED CHIPS
- CORRECT CHIPLOAD MUST BE MAINTAINED WITHIN A NARROW RANGE
- INCORRECT CHIPLOADS CAN LEAD TO KNIFE MARKS

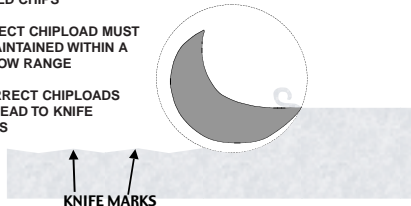

ROUGHING/FINISHING PASSES IN PLASTIC

AMOUNT TO LEAVE FOR A FINISH CUT

- 1/8" CED: .015" TO .030"
- 1/4" CED: .030" TO .080"
- 3/8" CED: .060" TO .125"
- 1/2" CED: .060" TO .125"
- NEVER LESS THAN .015"

CNC ROUTER SAWS

- FLUSH MOUNTS
THERMOFORMED PIECE REMOVAL
TYPICALLY SMALL DIAMETERS (< 2")
- ARBOR MOUNTS
TRIMMING, SLOTTING AND PIECE REMOVAL
TYPICALLY LARGER DIAMETERS (2"-4")
- HARD AND SOFT PLASTIC AVAILABLE (BE CAREFUL!)

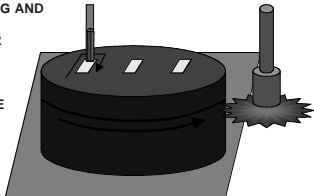

SOLID CARBIDE FINISHING TOOLS

The refinements of plastic routing continues to be enhanced through the development of edge finishing, shape, and bottom surfacing tools. Although the basic operation of these kinds of tools has been around in the metal and woodworking industry, the tool geometry for plastic machining was lacking. Onsrud Cutter in tune with the plastic materials and the cutting characteristics of these materials has developed a variety of tools to make the production of finished edges, shapes, and bottom surfaces a routine occurrence.

EDGE ROUNDING BITS



Edge rounding router bits are available in "O" flute, "V" flute, or spiral "O" flute configurations with single or double edges. Generally speaking, the user would select the "O" flute for soft plastic, the "V" flute for hard plastic, and the spiral "O" flute when the user wants to influence the chip in an upward direction. The double edges provide a better finish and the single edge promotes faster chip flow. The tools are best utilized on a raised spoilboard to center the radius and avoid unnecessary plunging into the spoilboard.

SOLID CARBIDE ROUT AND CHAMFER



The solid carbide rout and chamfer bit was designed to provide up to 1/16" top face chamfer and a finished edge on plastic sheets or parts. The multi-faceted design allows the CNC user to perform what was ordinarily a two-step process and complete the task in one pass without a tool change.

SOLID CARBIDE DOUBLE EDGE BOTTOM SURFACING



The bottom surfacing router bit in solid carbide upcut geometry provides a swirl free bottom in pocketing or lettering applications. The tool utilizes a near flat point with radiused corners to create a smooth bottom with aesthetically pleasing results.

SOLID CARBIDE DOUBLE EDGE UPCUT SPIRAL BALL NOSE



Solid carbide double edge ball nose tools are readily available for use in carving and modeling operations or as decorative round bottoms in plastic parts. These tools are offered in most nominal sizes and with extended lengths for five-axis CNC router where reach needs to be optimized.

PLASTIC DRILLS WITH SPECIAL POINT



The plastic machining industry has been at the mercy of inappropriately designed drills for years. The jobber drill and other similar tools were inadequate in terms of providing clean holes in plastic. A new style drill designed by Onsrud Cutter is available which allows fast plunge speeds with reduction of chip wrap in soft plastics and crazing in hard plastic. A 60° point and flat face rake provide the best plunging point to date in a wide variety of plastics. The new point reduces the stresses introduced into the hole walls and will provide a clean hole surface without clouding or crazing typical in standard drills.

TOOL EXTENDERS



Tool extenders are ideal for use with five-axis routers for trimming/routing of formed parts where extended reach is required.

ROUTING ALUMINUM

There are many types of aluminum's in two basic conditions. The conditions have more effect on the routing cuts than the types. The conditions are treated, which is hard, and untreated/annealed, which is soft. The hard material forms chips which can be routed much easier than the soft material.

The condition is noted on all materials from the manufacturer i.e. 6061 T-6 or 2024 O. If this is missing from the raw material, a simple bend test will indicate the type. If the material bends like solder, it is probably soft. If the material is difficult to form a bend and tends to spring back, it is likely hard. The common types and the difference in hardness

are noted in the chart. Note the hardness can be two to three times the soft condition as compared to the hard in most of the types shown. A good comparison of the two conditions is that they are similar to wood and plastics. Wood has the soft pliable – popular, cedar, pine, cottonwoods, versus the much harder rigid – oak, maple, hickory, teaks. Plastics are split into the soft flexible – ABS, PVC, polyethylene, polypropylene, UMHW, versus the harder rigid – acrylic, nylon, delrins.

Traditionally, high-speed steel (HSS) tools in spiral flutes have been used in routing aluminum for over 60 years. This tool material was used because it can carry a very sharp edge and is very tough. Most applications were hand fed or hand controlled and the other materials such as solid carbide (SC) were too brittle to be used in these operations. The advent of more advanced CNC routers, which have very good control of the feed has created more uses for the more refined SC tools. The newer SC tools have sharper stronger edges and are more shock resistant than earlier SC types.

As a general rule of thumb, most aluminum applications are covered by the use of HSS spirals in hand and older CNC applications, SC spirals in more advanced CNC applications, single edge tools for "O" condition aluminum and double edge tools for "T" condition aluminum.

ALUMINUM ALLOYS

- ALUMINUM HARDNESS CAN VERY WIDELY BECAUSE OF DIFFERENCES IN TEMPER.
- HARDER IS EASIER TO MACHINE.

ALLOY	BRINELL TEMPER	HARDNESS
3003	0	28
3003	H18	55
5052	0	47
5052	H34	68
5052	H38	77
2024	0	47
2024	T3, T4	120
6061	0	30
6061	T6	95
6063	T0	25
6063	T6	73
7075	0	60
7075	T6	150

GENERAL RULE OF THUMB:
 0 = Fully Annealed (soft)
 Hxx = Strain Hardened (medium)
 Tx = Solution Treated (hard)

AIR HAND ROUTERS



Most applications with these routers can be tied to material thickness. See the chart for typical loadings and selections. All the tools are downcut because upcut tools will pull the chips into the support bearing in the nose of the router guide and ruin it. Single edge tools are very aggressive and can be used with multiple flute SC tools in a secondary pass for part edge finishes that will be smoother than 125 rms. This can be a key issue for a part that will be formed after routing because the rough edge may propagate cracks during the forming process.

Double edge tools will be more stable in the cut because there is always one flute in contact with the part. They will yield a smoother finish in a single pass.

Cutting speeds of the tools are directly related to the tool diameter. A .125" tool will require about twice the spindle speed for the cutting edge to be as effective in shearing the chip from the part as a .250" tool. Note the spindle speeds in the chart.

AIR ROUTER CHART

PART THICKNESS, IN.	TOOL DIAMETER, IN.	SPINDLE SPEED, RPM	HORSEPOWER MIN.
.060	.125	30,000	.3
.090	.188	23,000	.6
.188	.250	18,000	.9
.375	.375	14,000	1.5

Note: Cutting material above .375 by hand is not recommended

ELECTRIC HANDROUTERS



The upcut is used to stabilize and force the part to bottom of the router. Since the chip has an exit path on the top of the part unlike the air router, it can clear itself from the cut path. See the chart under air routers for suggested parameters.

PINROUTERS

The pattern on pin routers is below the part. The downcut tool will push the part into the pattern, which is stabilized by forcing it down to the table. The chips are directed away from the operator's face and into a path used by the guide pin. Single edge tools will cut easier and faster because they cut and release the part. Double edge tools will generate better finishes and are more stable because one flute is always in contact with the part.

BROKEN ARM ROUTERS

Broken arm routers, also called master routers, were used mainly in the aerospace industry. Since CNC routers in most plants have replaced them, this equipment has migrated to the other industries, such as aluminum boats. A routing template, called a master, covers the sheets of thin aluminum. The master is screwed to the plywood tabletop that sandwiches the parts. Since there is no path for the chips to flow down, upcut tools must be used in this application. The stack height of the parts should never be above 1/2" in height. Single edge tools are used in "O" and double edge in "T". If a shop prefers to stock one tool, then use the single edge tool. Normal sizes for most applications are 5/16" CED on 1/2" shanks. This combination allows for small cut paths with the added strength of the larger shank because of the amount of tool required to extend from the collet and into the guide.

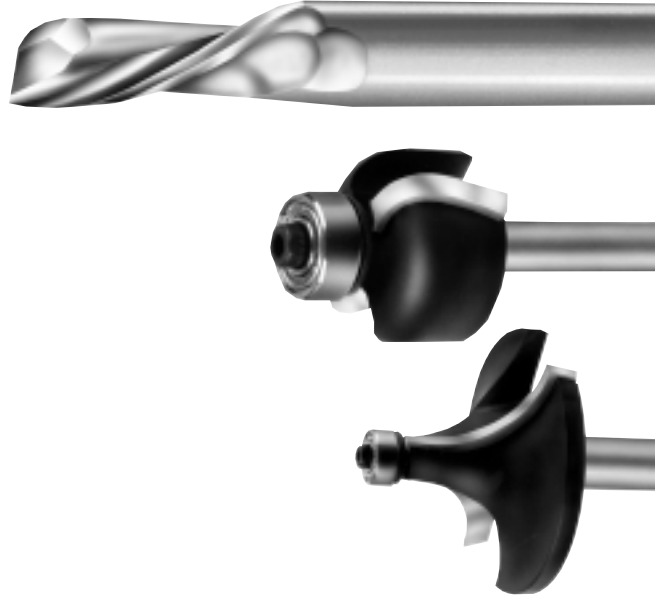

CNC ROUTERS

CNC routers are used for aluminum routing in four modes: single sheet, vacuum held, stack sheet-screw held, stack sheet-rievet held and stack sheet-pressure foot. In all operations conventional cut path is recommended. However, it is suggested that the scrap be examined. If it is cleaner than the part, then use climb cutting.

If two passes are needed because of tool deflection, higher requirement for part finish, or it is faster, then leave at least .030" (1/32") of material on the part for the finish cut. Use climb cut direction. Both of these items will stabilize the tool and should yield a better part finish. The single sheet applications run 14,000 to 24,000 RPM and up to 300 IPM feed. Stack sheets run 14,000 to 20,000 RPM and up to 160 IPM feed.

SINGLE SHEET

This operation has a composite wood table. The vacuum draws the part to the table and eliminates the use of fasteners to hold down the parts. Solid carbide tools are required due to the abrasiveness of the table. Skip tabs are recommended for smaller parts because they tend to move after several parts are cut which opens up more area for vacuum loss. Since most parts are less than .125" thickness, 1/8" and 3/16" tools can be used to help minimize vacuum loss by cutting a smaller path. Use the shortest CEL as possible.

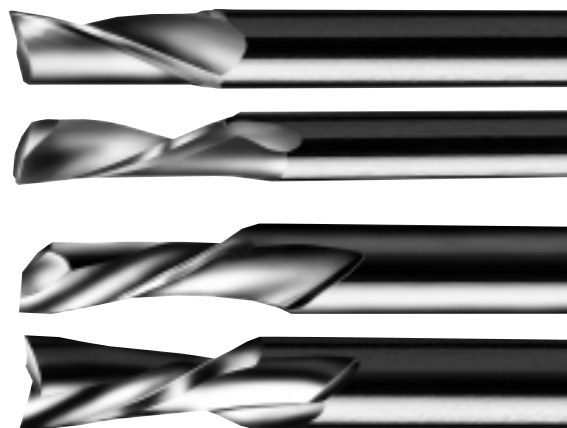

STACKED SHEET SCREW

In order to make a solid mounting for the screws, most tables are plywood. This allows the use of HSS spiral upcuts. Because the plies in the plywood are solid wood and not abrasive like the MDF or PB, the stack height should not exceed 1/2". An upcut is required because there is no exit path for the chips. Single edge tools mostly 1/4" to 5/16" on 1/2" shanks provide the most stable cuts and allow chips to be cut and cleared from the path. There will be some tool deflection. A secondary pass can be used to eliminate the variance. If a second pass is used, it should be in a climb cut direction and a minimum of .030" left on the part for the final cut.



STACKED SHEET-RIVET

This application requires the use of these lo-helix upcut tools so the chips can be evacuated without putting undue force on the rivets. If too much force is applied to the rivets, the deflection top sheets will lift from the stack and be ruined. The HSS tools can be used in most applications. The deflection can occur but, the 81-100 series reduces deflection to a minimal level. Solid carbide is used in the more abrasive high silica aluminums and lithium base aluminums. These machines normally use flood coolant. So a TCN or ZRN coating can sometimes increase tool life by 1-1/2 to 2 times normal. Tool tests on the specific machine are the only way to confirm.



STACKED SHEET PRESSURE FOOT

In order to pull the chips from the cut and make a large enough chip to absorb the heat, a single flute tool is required. It is necessary to run test cuts to see which, conventional or climb cutting direction, works best on each material.

COOLANTS

Coolants should be used on all CNC applications. The synthetic or soluble oil mists should be mixed at high water/coolant ratios to provide a greater measure of cooling effect. Flood coolants run best in applications for stack routing where the cut paths are deep. In hand router applications, a brushed on oil or dipping the tool in bee's wax or bar soap will add lubricity to the cutting action and extend tool life.

COOLANTS FOR ALUMINUM ROUTING

- ACTUALLY A LUBRICANT MORE THAN A COOLANT
- CNC ROUTERS
 - FLOOD
 - MIST
 - TYPICALLY WATER SOLUBLE AND ENVIRONMENTALLY FRIENDLY
 - RATIOS CAN VARY FROM 30:1 TO 50:1
 - IMPROPER RATIO CAN DRAMATICALLY AFFECT THE USEFULNESS
- HAND ROUTERS
 - STICK WAX OR WIPED WAX
 - SOAP

CHIP WELDING

This can be caused by many different factors or a combination of them. Spindle run-out and the wrong tool type are the most common errors. Dull tools, poor chip loads, wrong feed direction, loss of coolant during the cut are other factors that contribute to chip welding on the cutting edge. Chips welding back into the cut path occurs when the chip load is too light or the flute of the tool cannot eject it. This can happen when the CEL is not long enough to clear the top of the deep cuts.

HEELING

This is a common occurrence when there is excessive spindle run-out. It also happens when the feed rates are too slow on a CNC router and the chips are forced in to the back of the tool because they cannot be ejected for the cut path.

TROUBLE SHOOTING/TOOL BREAKAGE

The tool can be the weakest part of the routing system. When the router bit breaks, it becomes the first line of suspicion. However, almost 80% of breakage problems can be attributed to the following factors: 1) poorly maintained or worn equipment 2) improper tooling and fixturing. (Poorly maintained equipment includes: collets, collet nuts, spindle bearings, spindles, and spindle housings, slides and head control items. These points and others have previously been discussed).

POORLY MAINTAINED OR WORN EQUIPMENT

When breakage occurs, the first line of defense is to make a thorough inspection of the tool holding system. Inspection should include the cleanliness of the area and the condition of the collet and collet nut. Examine the shank of the tools for poor collet contact or "collet burn". This will show as brownish, burned marks on high speed steel and carbide tipped tools and appears as shiny marks on solid carbide tools. If the collet is worn or damaged, replace the collet or merely clean the area per the instructions in the Collet Maintenance section of this manual.

The following items require the machine to be turned off and the operating items shutdown for safety reasons. Grabbing the spindle by hand and checking it for play or looseness can be a quick check of the slides, bearings, and head mountings. This will point out most unacceptable conditions. If more accurate documentation is needed, the magnetic base indicator and test bar or plug gauge. This process involves indicating the spindle as well as several spots on the test bar as it is engaged in the collet. To further discuss this procedure, e-mail www.techsupport@onsrud.com.

IMPROPER TOOLING AND FIXTURING

The selection of inappropriate tooling for an application can lead to finish and breakage problems. Consult the Onsrud Cutter catalog, website, area distributor, or Onsrud Cutter representative to determine proper tool selection. Review the Spoilboard Techniques section to insure parts are being held rigidly in place and chip flow is enhanced by the spoilboard design. Poor finish many times can be the early sign of breakage or life problems. Check the feed direction. It should be conventional cutting for most applications. If the proper tool geometry is employed, climb cutting is not considered. Check for dull tools. Tool life is short in some materials. Check for burrs on the cutting edge. Some materials will run faster and cleaner by using a roughing and finishing pass. Examples are expanded PVC and solid wood. Chipbreaker tools can be accompanied by a finishing tool pass producing superior quality parts in about the same cycle time as with one tool. Multiple spindles or tool changer is required.

TROUBLE SHOOTING POINTERS

<u>PROBLEM</u>	<u>CAUSE</u>	<u>SOLUTION</u>
<u>TOOL BREAKAGE</u>	Excessive Cutting Edge Length	<i>Use shortest CEL to achieve depth of cut</i>
	Improper Colletting	<i>Collet only on smooth surface of shank at the end of the flute fade out</i>
	Poor Maintenance of Collet, Nut & Spindle	<i>Identify proper procedure for cleaning collet nut & spindle</i>
		<i>Change collets on a regular basis</i>
	Cutting Edge Diameter Less Than Shank Diameter	<i>Go to straight through tool with CED & shank the same</i>
	Use of Adapter Bushings	<i>Utilize proper collet size</i>
	Machine Problems	<i>Check collet & spindle runout-Check for play in slides, bearings or head mountings</i>
	Part Movement	<i>Check vacuum hold down & clamping devices to insure part rigidity</i>
	New or Inexperienced Operator	<i>Part should be fed smoothly to allow router tool to cut freely</i>
	Poor Tool Selection	<i>Match tool with material being machined</i>

	Breakage Problem	<i>Have manufacturer do quality check</i>
TOOL LIFE	Poor Tool Selection	<i>Match tool with material being machined</i>
	Speeds & Feeds	<i>Make proper changes to improve chipload & heat removal</i>
	Poor Dust Collection	<i>Improve dust collection capability to remove chips & heat</i>
	Part Movement	<i>Check vacuum hold down & clamping devices</i>
	Machine Problems	<i>Check condition of collets, collet nuts, spindles, slides, bearings and head mountings</i>
	Material Being Machined	<i>Select right tool for the job</i>
PART FINISH	Dull Tools	<i>Check for edge deterioration & replace with new or resharpened tools</i>
	Tool Selection	<i>Double edge or multi-edge tools provide better finish</i> <i>Use shortest CEL available to make necessary depth of cut</i> <i>Use keener edged HSS tools on natural wood & some plastics to improve finish</i> <i>Use up/down compression spirals to improve top & bottom finishes on veneered or laminated materials</i>
	Feed Direction	<i>Should be conventional for most applications</i>

GLOSSARY

ABRASIVE WEAR – THE WEAR THAT OCCURS WITH FRICTION AND HEAT OF THE CUTTING ACTION THAT DULLS THE TOOL.

ANGLE – THE AMOUNT OF DIVERGENCE BETWEEN TWO STRAIGHT LINES THAT MEET AT A VERTEX. MEASURED IN DEGREES AND MINUTES.

ARBOR – A MACHINE TOOL SPINDLE SHAFT EXTENSION USED TO HOLD GRINDING WHEELS OR MILLING CUTTERS.

AXIAL LOAD – THE VERTICAL DEPTH OF CUT PERPENDICULAR TO THE CENTER LINE OF THE CUTTING TOOL, NORMALLY EXPRESSED IN A PERCENTAGE OF THE DIAMETER OF THE TOOL.

AXIS – THE CENTER LINE (REAL OR IMAGINARY) PASSING THROUGH AN OBJECT ABOUT WHICH IT COULD ROTATE. A REFERENCE POINT OR LINE FOR A SYSTEM OF CNC MACHINE TOOL COORDINATES (I.E. X, Y, Z).

BACK-OFF – A SHOP TERM MEANING TO PUT RELIEF OR CLEARANCE LAND BACK OF THE CUTTING EDGE OR BEHIND THE PRIMARY CLEARANCE.

BACKLASH – LOST MOTION (PLAY) IN MOVING PARTS, SUCH AS THREAD IN A NUT OR THE TEETH OR MESHING GEARS CAN REEK HAVOC WITH SIZE CONTROL.

BALLNOSE – A 180 ARC GROUND ON THE PLUNGE POINT OF THE TOOL

BALL RADIUS – USED IN THE DESCRIPTION OF “O” AND SPIRAL

FLUTES. THE MAXIMUM FLUTE DEPTH FROM FLUTE CENTER TO A LINE PERPENDICULAR TO THE CUTTING EDGE. IF THE ARC IS CONTINUED AROUND TO COMPLETE AN IMAGINARY CIRCLE OR BALL IT BECOMES THE BALL DIAMETER AND IS SOMETIMES DESCRIBED AS SUCH.

BINDER – THE METALLIC CONSTITUENT IN CARBIDE WHICH HOLDS THE GRAINS TOGETHER.

BODY – THE ACTIVE PORTION OF A ROUTER BIT WHICH INCLUDES THE CUTTING EDGE AND ALL CLEARANCES NECESSARY TO ACHIEVE A SPECIFIED CUTTING DIAMETER.

BRAZING – THE JOINING OF METALS BY HEATING A NON-FERROUS METALLIC ALLOY, COMBINED WITH A SUITABLE FLUX, TO ITS LOWER MELTING POINT TO BECOME THE BINDING MEDIUM. ADVANTAGE, NEITHER METAL JOINED IS DEFORMED. ONSRUD TECHNIQUES INVOLVE A COPPER-SILVER ALLOW COMBINED WITH A BORAX FLUX.

BURNING – OVERHEATING OF THE TOOL AND RESULTANT SURFACE DISCOLORATION CAUSED BY EXCESSIVE SPEEDS AND FEEDS.

CARBIDE TIPPED TOOLS (CT) – CUTTING TOOLS WITH TUNGSTEN, TANTALUM, OR OTHER CEMENTED CARBIDE INSERTS BRAZED TO A SOFTER STEEL FLUTE FACE.

CENTERLESS GRINDING – A SPECIFIC GRINDING PROCESS WHERE THE WORKPIECE IS SUPPORTED BY A BLADE REST AND NOT HELD BETWEEN CENTERS. WORKPIECE FEED RATE IS CONTROLLED BY A REGULATING WHEEL.

CERAMIC – A NEW MAN MADE COMPOSITE CUTTING MATERIAL CONTAINING TWO OR MORE ORGANIC, INORGANIC, OR METALLIC MATERIALS. A POPULAR CERAMIC RECIPE IS A MIXTURE OF ALUMINUM OXIDE WITH SILICON CARBIDE FIBERS FOR STRUCTURAL ENHANCEMENT.

CHAMFER – THE BEVELED SURFACE USED TO ELIMINATE AN OTHERWISE SHARP CORNER (I.E. SHANKS). EXPRESSED IN LENGTH AND ANGLE.

CHATTER – PERIODIC DEFLECTION OF A WORKPIECE DURING A MACHINE TOOL OPERATION WHICH CAN LEAVE UNDESIRABLE SURFACE CONFIGURATIONS.

CHIPBREAKERS – NOTCHES, GROOVES, AND SIMILAR FEATURES DESIGNED TO BREAK UP CHIPS FOR FAST, CLEAN, AND EFFICIENT REMOVAL. REDUCES OVERALL CHIP LOAD.

CHIPBREAKER TOOLS - HOGGERS

CHIP DRAG – THE CLOGGING, LOADING, AND PACKING DUE TO IMPROPER CHIP EXTRACTION.

CHIP LOAD – THE AMOUNT OF MATERIAL REMOVED BY ONE TOOTH PER CUTTING REVOLUTION.

CHIP LOAD = FEED RATE / (RPM X NUMBER OF CUTTING FLUTES).

CHIPS – THE PIECE OF WASTE LEFT AFTER CUTTING.

CLEARANCE – AT ONSRUD, THE TERM CLEARANCE IS OFTEN USED TO DESCRIBE RELIEF. THEREFORE, IN AN EFFORT TO CONFORM TO ASME STANDARDS, THE PREFERRED TERM FOR PRIMARY CLEARANCE IS "RELIEF" AND FOR SECONDARY CLEARANCE IS "CLEARANCE".

CLEARANCE ANGLE – THE ANGLE FORMED BETWEEN THE CLEARANCE SURFACE AND A PLANE TANGENT TO THE CUTTING EDGE.

CLEARANCE, OVERALL – THE TOTAL CLEARANCE DISPLACED FROM THE CUTTING EDGE TO THE HEEL. IT IS EXPRESSED IN ANGLE AND AMOUNT OF INDICATOR DROP.

CLEARANCE, SECONDARY – (SEE PREFERRED TERM CLEARANCE) THAT CLEARANCE CONTAINED DIRECTLY BEHIND RELIEF (PRIMARY CLEARANCE). IT IS USUALLY EXPRESSED IN ANGULAR TERMS AND CAN BE AXIAL OR RADIAL IN DIRECTION OF MEASURE.

CLEARANCE (OR RELIEF) SURFACES – ANGULAR OR CURVED SURFACES BEHIND THE RELIEF LAND. **CONCAVE** – THAT CLEARANCE SURFACE THAT COMPRISES A CURVED DEPRESSION. **ECCENTRIC** – THAT CLEARANCE SURFACE THAT IS CONVEX OR ROUNDED AND NOT ABOUT A COMMON CENTER TO THE CUTTING EDGE. **FLAT** – THAT CLEARANCE SURFACE THAT IS ESSENTIALLY STRAIGHT OR FLAT.

CLIMB CUT – IN CNC ROUTING WITH RIGHT HAND ROTATIONAL TOOLING, ROUTING THE PERIMETER OF THE WORKPIECE IN A CLOCKWISE DIRECTION IS CLIMB CUTTING. ON INTERNAL CUTS CLIMB CUTTING IS COUNTER CLOCKWISE.

CNC – COMPUTER NUMERIC CONTROL. CUTTING ACTION AND WORKPIECE MOVEMENT CONTROLLED BY A COMPUTER PROGRAM. IT CAN BE PREPARED IN ADVANCE OR INPUT BY THE OPERATOR.

COLLET – A STANDARD TRISECTED HOLLOW CLAMPING OR CHUCKING DEVICE DESIGNED TO CLOSE TIGHTLY UPON A WORKPIECE WHEN DRAWN BACK AGAINST A TAPERED SLEEVE BY A DRAW BAR OR TUBE.

COMPARATOR – AN OPTICAL IMAGE MEASURING TOOL CAPABLE OF PRECISE CLEARANCE MEASUREMENTS AND GEOMETRY COMPARISONS THROUGH VISUAL MAGNIFICATION.

CONCENTRICITY – HOLDING A CONSISTENT RADIUS ABOUT A COMMON CENTER OR TOOL AXIS WITHIN A SPECIFIC TOTAL INDICATOR RUNOUT (TIR).

CONVENTIONAL CUT – IN CNC ROUTING WITH RIGHT HAND ROTATIONAL TOOLING, ROUTING THE PERIMETER OF THE WORKPIECE IN A COUNTER CLOCKWISE DIRECTION IS CONVENTIONAL CUTTING. ON INTERNAL CUTS CONVENTIONAL CUTTING IS CLOCKWISE.

CORE (WEB) DIAMETER – THE DIAMETER OF A CIRCLE WHICH IS TANGENT TO THE BOTTOM OF THE FLUTES.

CORNER RADIUS – A RADIUS GROUND ON THE CORNER OF THE PLUNGE OF THE ROUTER BIT.

CUTTING EDGE – THE SHARPENED, WORKING PORTION, OR LEADING EDGE OF A CUTTER TOOTH.

CUTTING EDGE DIAMETER – THE DISTANCE FROM A CUTTING EDGE TO A POINT IT WOULD OCCUPY UPON 180 ROTATION. THE MAXIMUM WIDTH OF CUT POSSIBLE. THE DIAMETER OF A CUTTING TOOL'S PERIPHERY.

CUTTING EDGE LENGTH (CEL) – AS APPLIED TO END MILLS, THE EFFECTIVE AXIAL CUTTING EDGE NOT INCLUDING THE CUTTER SWEEP WHICH PERFORMS SIDE CUTTING ON THE WORKPIECE.

CUTTING FEED – RATE AT WHICH THE TOOL PASSES THROUGH THE WORK. CAN BE EXPRESSED IN TERMS OF TABLE TRAVEL, NORMALLY EXPRESSED IN INCHES PER MINUTE.

CUTTING SPEED – NORMALLY EXPRESSED IN REVOLUTIONS PER MINUTE. FOLLOW MACHINE MANUFACTURER RECOMMENDATIONS.

CUTTING SWEEP – EXIT POINT OF GRINDING WHEEL WHEN TOOLS ARE INITIALLY FLUTED.

DE COMPRESSION – UP DOWNS, OR 2+2 UP DOWNS

DEFLECTION – OVERALL LOSS, OR UNEVEN WORKPIECE CONTACT WITH THE GRINDING WHEEL OR MILLING CUTTER DURING A MACHINE TOOL OPERATION. USUALLY A RESULT OF TOO HIGH A FEEDRATE, TOO MUCH STOCK REMOVAL OR IMPROPER REST POSITIONING.

DEGREE AND MINUTES – UNITS OF MEASURE FOR ANGULAR ROTATION 360 DEGREES PER CIRCLE OR ONE COMPLETE REVOLUTION AND 60 MINUTES PER DEGREE.

DOVETAIL – A CUTTING DIAMETER THAT PROGRESSIVELY DECREASES FROM THE LEADING EDGE TO THE SHANK (ALSO CALLED BACK TAPER) DELIVERING WHAT ARE COMMONLY CALLED “DOVETAIL ANGLED” CUTS.

DOWNCUT – A CUTTING EDGE HELIX THAT SPIRALS OPPOSITE TOOL ROTATION. IT IS DESIGNED TO FORCE CHIP REMOVAL DOWN WITH PLUNGE.

FACE – CUTTING EDGE FACE – THE AXIAL CUTTING LENGTH OF A CUTTING TOOL

FLUTE FACE – FLAT PORTION OF A FLUTE PERPENDICULAR TO THE WEB AND TERMINATED BY THE CUTTING EDGE.

GRINDING WHEEL FACE – THAT PART OF A GRINDING WHEEL WHICH ACTIVELY ENGAGES THE WORKPIECE.

FADE OUT – (CUTTER SWEEP) – THAT PORTION OF THE FLUTE LEFT BY THE GRINDING WHEEL OF MILLING CUTTER AS IT RETRACTS OR WITHDRAWS FROM THE WORKPIECE. IT LIES IN THE TOOL NECK, AN AREA BETWEEN THE CEL AND SHANK.

FEEDRATE – THE SPEEDS AND FEEDS A MACHINE TOOL USES TO PERFORM SAFE, RESULTANT WORK. RPM – REVOLUTIONS PER MINUTE IS APPLIED TO ANY ROTATIONAL MOVEMENT; IPM – INCHES PER MINUTE IS APPLIED TO ANY LINEAR MOVEMENT.

FEED, CROSS – THE DISTANCE AND RATE OF HORIZONTAL FEED OF THE WHEEL ACROSS THE TABLE.

FEED IN (TRAVERSE) – THE DISTANCE AND RATE WHICH THE WHEEL IS FED INTO THE WORK.

FEED ELEVATION – THE VERTICAL FEED ON A TOOL GRINDER COLUMN WHICH WHEN LOWERED, LOWERS THE ENTIRE GRINDING HEAD; THE VERTICAL FEED OF A MILLING TABLE KNEE WHICH WHEN RAISED, RAISES THE ENTIRE WORKHEAD.

FEED INDEX – MEASUREMENT INDICATED BY THE CROSS-INDEX OF A MACHINE. THIS MEASUREMENT USUALLY REFERS TO THE WORKPIECE DIAMETER, BUT SOMETIMES THE RADIUS IS USED.

FLUTE – A STRAIGHT OR HELICAL GROOVE OF ANGULAR OR RADIAL FORM MACHINED INTO A TOOL TO PROVIDE CUTTING EDGES, PERMIT CHIP REMOVAL, AND ALLOW CUTTING FLUID CIRCULATION.

FLUTE LENGTH – THE LENGTH OF THE FLUTES MEASURED IN A STRAIGHT LINE ALONG THE AXIS.

FORM CUTTER – ANY CUTTER SHAPED TO PRODUCE A SPECIFIED FORM ON THE WORK (I.D. ROUND OVER)

FULL GRIP – REFERS TO THE TYPES OF COLLETS WITH SLITS FROM BOTH ENDS OF THE COLLET. THESE COLLETS TYPICALLY GRIP THE SHANK FOR 100% OF THE OVERALL LENGTH OF THE COLLET.

GRADE – THE DESIGNATION GIVEN TO A PARTICULAR GRADE OF CARBIDE.

HALF GRIP – REFERS TO THE TYPES OF COLLETS WITH SLITS FROM ONE END ONLY. THESE COLLETS TYPICALLY GRIP THE SHANK FOR ONLY 50-60% OF THE OVERALL LENGTH OF THE COLLET.

HAND OF MILLING CUTTERS & END MILLS – THE TERMS “RIGHT HAND” OR “LEFT HAND” ARE USED TO DESCRIBE HAND OF ROTATIONS OR HAND OF CUT, AND HAND OF FLUTE HELIX.

HAND OF ROTATION – OR (HAND OF CUT) – THE ROTATION OF A CUTTING TOOL REVOLVING SO AS TO MAKE A CUT WHEN REVIEWED FROM A POSITION IN FRONT OF A HORIZONTAL MILLING MACHINE AND FACING THE SPINDLE.

RIGHT HAND ROTATION – COUNTERCLOCKWISE ROTATION (OR WHEN TOOL IS VIEWED FROM SHANK, IT IS DESIGNED TO ROTATE TOWARDS THE RIGHT HAND).

LEFT HAND ROTATION – CLOCKWISE ROTATION (OR WHEN TOOL IS VIEWED FROM SHANK, IT IS DESIGNED TO ROTATE TOWARDS THE LEFT HAND).

HAND OF FLUTE HELIX – THE DIRECTION THE FLUTE TWISTS AWAY FROM THE OBSERVER AROUND THE TOOL AXIS WHEN VIEWED FROM EITHER END OF THE CUTTING TOOL.

RIGHT HAND HELIX – CLOCKWISE FLUTE TWIST (TO THE RIGHT HAND)

LEFT HAND HELIX – COUNTERCLOCKWISE FLUTE TWIST (TO THE LEFT HAND)

STRAIGHT FLUTES – TOOLS WITH THEIR CUTTING EDGES IN PLANES PARALLEL TO THE TOOL AXIS (NO HELIX).

HEEL , HEELING – THE HEEL IS THE AREA DIRECTLY BEHIND THE CUTTING EDGE. HEELING IS CAUSED BY INSUFFICIENT RELIEF BEHIND THE CUTTING EDGE.

HELIX – THE PATH A POINT WILL GENERATE AS IT MOVES AT A FIXED RATE OF ADVANCE (SPIRALS) ALONG THE SURFACE OF A CYLINDER.

HELIX ANGLE – THE CUTTING EDGE ANGLE WHICH A HELICAL CUTTING EDGE MAKES WITH A PLANE CONTAINING THE TOOL'S AXIS.

HELICAL (SPIRAL) – A TERM DESCRIBING A CUTTING EDGE OR FLUTE WHICH PROGRESSES UNIFORMLY AROUND A CYLINDRICAL SURFACE IN AN AXIAL DIRECTION.

HOOK – SEE RAKE.

IPM – INCHES PER MINUTE

LAND – THE NARROW SURFACE OF A PROFILE SHARPENED CUTTING TOOL IMMEDIATELY BEHIND THE CUTTING EDGE.

CYLINDRICAL – A NARROW PORTION OF THE PERIPHERAL LAND ADJACENT TO THE CUTTING EDGE, HAVING NO RADIAL RELIEF (CLEARANCE).

RELIEVED – A NARROW PORTION OF THE LAND, ADJACENT TO THE CUTTING EDGE WHICH PROVIDES RELIEF (CLEARANCE).

NOT RELIEVED – A NARROW PORTION OF THE LAND, ADJACENT TO THE CUTTING EDGE, HAVING NO RELIEF (CLEARANCE).

LEFT HAND CUT – A TOOL WITH THE FLUTES AND CUTTING EDGES SPIRALING LEFT. COUNTER-CLOCKWISE ROTATION.

LUBRICITY – THE PROPERTY THAT WILL ALLEVIATE FRICTION. SPECIAL COATINGS HAVE THE ABILITY TO MAKE THE TOOL VERY LUBRIFIC (SLIPPERINESS).

OVERLOAD BREAKAGE – CHIP LOAD PER TOOTH IS OVERLOADING THE CUTTER, WHICH RESULTS IN TOOL BREAKAGE.

PART NUMBER – THE NUMBER USED TO DESIGNATE A SPECIFIC TOOL DIAMETER AND DESIGN FOR PRINT, TRAVELER, CATALOG AND WARRANTY FILING AND REFERENCE.

RADIAL LOAD – THE HORIZONTAL DEPTH OF CUT PARALLEL TO THE CENTER LINE OF THE CUTTING TOOL, NORMALLY EXPRESSED IN A PERCENTAGE OF THE DIAMETER OF THE TOOL.

RAKE – THE ATTACK ANGLE OF THE TOOL.
(SEE PAGE 5 RAKE AND CLEARANCE)

RELIEF – (SEE CLEARANCE) THE RESULT OF THE REMOVAL OF TOOL MATERIAL DIRECTLY BEHIND OR ADJACENT TO THE CUTTING EDGE TO PROVIDE CLEARANCE AND PREVENT RUBBING (HEEL DRAG). IN THE INTEREST OF CONFORMITY, RELIEF IS THE ASME PREFERRED TERM FOR WHAT ONSRUD CUTTER REFERS TO AS “PRIMARY CLEARANCE”. IT GENERALLY LIES WITHIN THE FIRST 1/16” DIRECTLY BEHIND THE CUTTING EDGE AND IS EXPRESSED IN ANGLE AND LAND WIDTH.

RIGHT HAND CUT – A TOOL WITH FLUTES AND CUTTING EDGES SPIRALING RIGHT. CLOCKWISE ROTATION.

SE COMPRESSION – UP DOWNS OR 1+1 UP DOWNS

SHANK – THAT PROJECTING PORTION OF A ROUTER BIT OR OTHER END MILL WHICH LOCATES AND DRIVES THE ROUTER BIT IN THE MACHINE SPINDLE ON ADAPTER.

SPINBACK – A SECTION OF REDUCED DIAMETER FROM THE CUTTING EDGE AT THE FLUTE FADE OUT AND/OR A PORTION OF THE SHANK OF THE ROUTER BIT

SPINDLE – A PRECISION BEARING MOUNTED STEEL SHAFT USED TO TRANSFER MOTOR POWER AND RETAIN ARBOR, COLLET AND WORK PIECES.

SPIRAL – A TOOL WITH HELICAL CUTTING EDGES AND FLUTES.

TANGENT OF AN ANGLE – IN A RIGHT TRIANGLE IT IS THE RATIO OF THE SIDE OPPOSITE THE ANGLE TO THE SIDE ADJACENT. A LINE THAT TOUCHES A CIRCLE AT ONE SPECIFIC POINT ONLY ALONG ITS CIRCUMFERENCE.

TAPER – THE UNIFORM INCREASE OR DECREASE OF A TOOLS DIAMETER TO FORM A CONICAL OR WEDGE SHAPE – SPINDLES – TOOL HOLDER.

TRANSVERSE RUPTURE STRENGTH (TRS) – THE BREAKING STRENGTH IN STANDARD BENDING TESTS (SIDE PRESSURE STRENGTH).

UPCUT – A CUTTING EDGE HELIX THAT SPIRALS WITH TOOL ROTATION. IT IS DESIGNED TO FORCE CHIP REMOVAL UP AND OUT OF THE ACTIVE CUTTING AREA.

V-FLUTE – OFTEN CALLED Z-FLUTE WITH DE TOOLS

WEAR LAND – THE AREA JUST BEHIND THE CUTTING EDGE RESULTING FROM THE NORMAL DULLING REACTION. FORMS A BRIGHT SHINY FINISH BEHIND THE CUTTING EDGE AND IS A GOOD INDICATOR TO CHANGE THE TOOL OUT.

WEB – THE BODY MATERIAL ABOUT THE TOOL AXIS ON CENTER THAT REMAINS AFTER FLUTING AND CONNECTS THE WINGS.

WELDON SHANK – A STRAIGHT SHANK WITH SPECIAL FLATS FOR DRIVING AND LOCATING THE TOOL.

WING – THE BODY MATERIAL THAT TERMINATES THE WEB AND CONTAINS THE FLUTE FACE, CUTTING EDGE, CLEARANCE LAND, AND HEEL.



A member of the  LMT group



ONSRUD

ONSRUD CUTTER LP

ONSRUD CUTTER LP

800 Liberty Drive
Libertyville, IL 60048 USA
TOLL FREE: 800/234-1560

www.onsrud.com

www.plasticrouting.com

ISO 9001 Certified

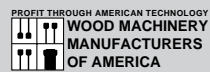

American Supply & Machinery
Manufacturers' Association, Inc.



Leitz Metalworking Technology Group