

**Cupola Data**  
 Overall Height = 13'-11"  
 Base Width = 6'  
 Unit Weight = 800 lbs.

**Optional Window Panels**

304

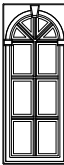

Keystone

311

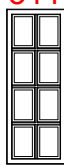

Squared

306



Round Top

Note: Windows also available without panes.

**Optional Cupola Finials**

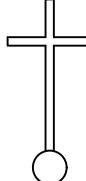

36" Cross  
8"Ø Sphere



36" Aluminum Spire  
8"Ø Sphere

Weathervane selection at :  
[www.whitehallproducts.com](http://www.whitehallproducts.com)

Base Panel: WR comes standard with 8 K-glass windows. See above for optional window designs.

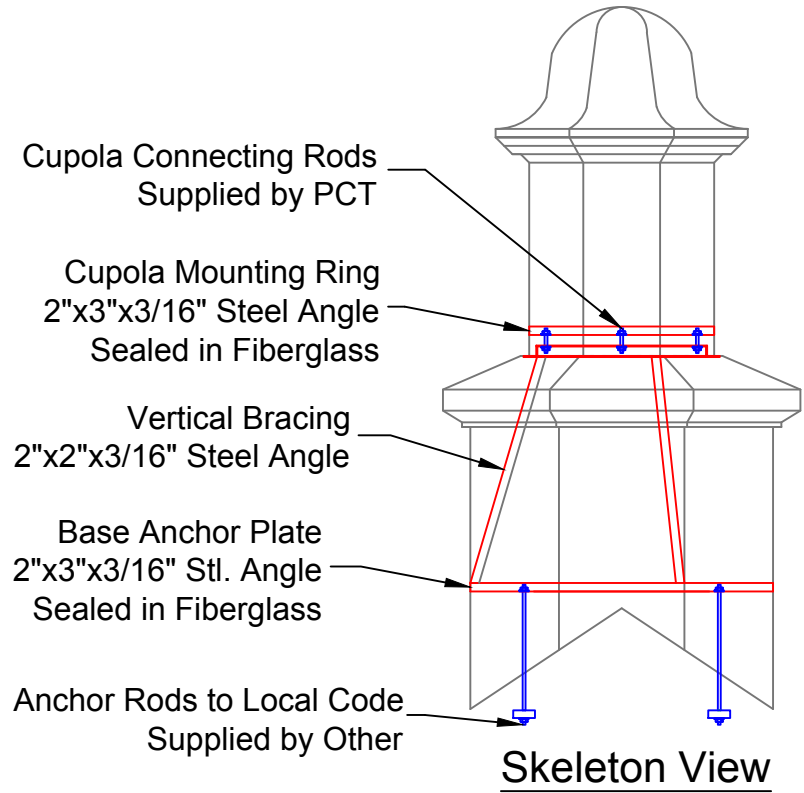
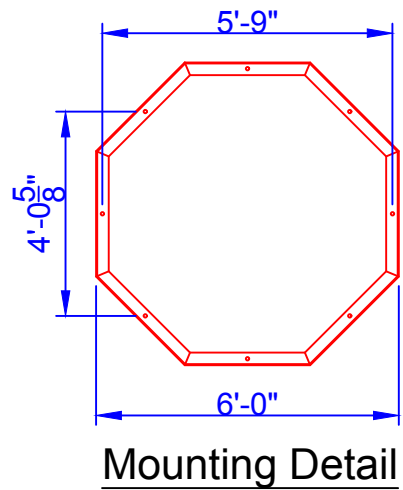
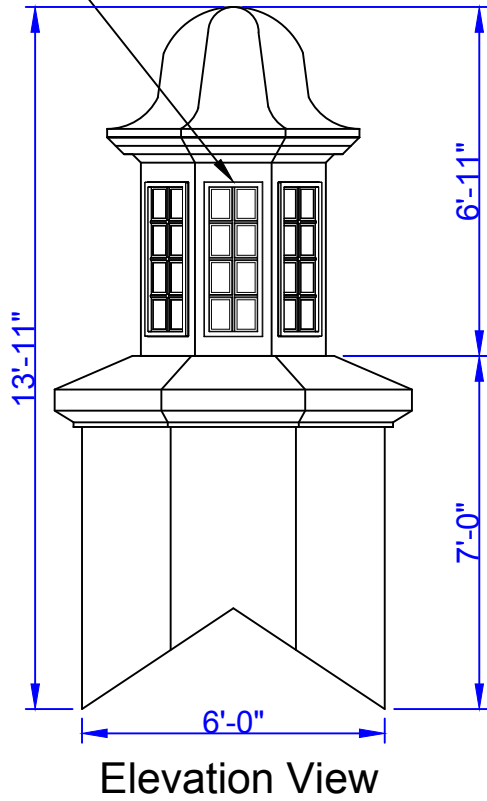

33 Lewittes Rd.  
 Taylorsville, NC 28681  
 Phone: 828-632-8883  
 Fax: 828-632-5585  
[www.piedmontcomposites.com](http://www.piedmontcomposites.com)

**CUPOLA**

Model : **870WR**

Scale:  
 N/A  
 Drawn by:  
 C.BOTHOS  
 Created On  
 -  
 Updated On  
 03/27/19

Note: All drawings are the property of Piedmont Composites & Tooling, LLC. Variation in material thickness, dimension and weight may occur. PCT reserves the right to change or modify design at anytime without notice.