

## **Type B Gas Vent**

**Type B gas venting system.**

**UL 441 and ULC S605.**

## **DuraFlex® AL**

**Aluminum flexible relining**

**UL 1777 & ULC S635.**



## Specifications

### Applications

DuraVent's Type B Gas Vent system. Use with natural gas or liquid propane category I and draft hood equipped appliances, and appliances tested and listed to use Type B Gas Vent. Applications include: natural gas fireplaces, gas-fired furnaces, boilers, water heaters, and wall or space heating applications.

### Materials and Construction

Round Type B Gas Vent 3" - 8" and oval 4" - 6": Aluminum .012" inner wall, galvanized .018" outer wall.  
Round Type B Gas Vent 10" - 16": Aluminum .016" inner wall, galvanized .021" outer wall.  
Round Type B Gas Vent 18" - 30": aluminum .020" inner wall, galvanized .021" outer wall.  
3"-16" diameters feature twist-lock fittings, screws required for 14" and larger diameters.

### Clearances

1" clearance to combustibles in single and multi-family dwellings.

### Diameters

3"- 30" Round Diameter.  
4", 5", and 6" Oval.

### Listings

UL Listed to UL 441 and UL 1777 (MH6357).  
ULC Listed to ULC S605 (CMH1276 & CMH1407).



## UL 441 and ULC S605 System

### Type B Gas Vent

DuraVent's innovative system for a lock-tight connection for Type B Gas Vent called DuraLock. See the alignment indicators meet; feel the ends grasp together; hear the snap as the connection firmly locks into place. (See next page.)

DuraVent Type B Gas Vent is designed to meet the rugged demands of the job site. The inner wall is recessed to eliminate damage in handling.

Type B Gas Vent has been engineered to heat up rapidly. It remains hot during the operation of the appliance with minimal condensation in the appliance and vent system. Pipe lengths are available in multiple lengths, 6 to 60 inches, with a full complement of adjustable and rigid fittings.

Type B gas vents are not suitable for use with wood-burning or coal applications, industrial ovens, exhaust ranges and hoods, grease or pollution ducting, or as free-standing exhaust vents for high-temperature applications.



## c-UL-us 441 System

### DuraConnect II

Double-wall connector pipe, UL approved as a Type B Gas Vent segment, for use in conditioned and unconditioned attics and crawl spaces. (Not to be enclosed and cannot penetrate through walls, floors, or ceilings.) DuraVent's DuraConnect II is known as the "Contractor's Choice" for its ease of installation and durability.

DuraConnect II's heavy-duty construction features precision twist-lock connection, which provides ease of assembly or disassembly without damage to the product.

The double-wall flexible vent is certified as having the equivalent thermal properties as Type B Gas Vent and can be used when a Type B Gas Vent double-wall connector is required.

## UL 1777 & ULC S635 System

### DuraFlex AL

An economical venting system used for relining masonry chimney for natural gas or liquid propane category I, draft hood equipped appliances, and appliances tested and listed to use Type B Gas Vent for a wide range of applications, including: natural gas fireplaces, gas-fired furnaces, boilers, water heaters, and wall or space heating applications. Protects the masonry chimney from damaging effects of flue product condensation.



## Specifications

### DuraConnect II

#### Materials and Construction

.010" Double-wall aluminum flex inner wall (two-ply .005"), .018" galvalume outer wall, with twist-lock connections.

#### Clearances

1" to combustibles.

#### Diameters

3" - 6".

#### Listings

c-UL-us Listed to UL 441 and ULC/ORD-C441 (MH14089).



### DuraFlex AL

#### Applications

**DuraFlex AL (DFAL)** aluminum flexible relining for masonry chimney. Use with natural gas or liquid propane category I, draft hood equipped appliances, and appliances tested and listed to use Type B Gas Vent. Applications include: natural gas fireplaces, gas-fired furnaces, boilers, water heaters, and wall or space heating applications.

#### Materials and Construction

Single-wall .010" aluminum (2-ply of .005").

#### Clearances

0" clearance to masonry.

#### Diameters

3", 4", 5", 5 1/2", 6", 7", and 8".

#### Listings

Listed to UL 1777 and ULC S635.



# What makes us different from the rest?

## DuraVent's Type B Gas Vent: A completely engineered system.



No sharp tabs to bend into slots. Twist locks into place.

Designed to meet the rugged demands of the job site with a recessed inner wall

Innovative system for a firm, lock-tight connection

Remains hot during operation with minimal condensation

Engineered to heat-up rapidly.

Limited Lifetime Warranty

## Typical Installations

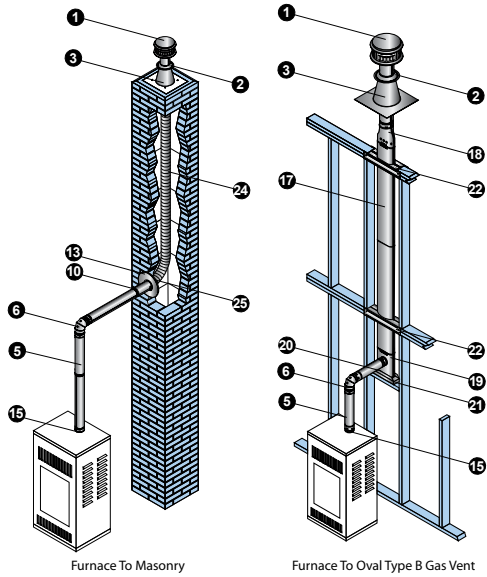

Furnace To Masonry

Furnace To Oval Type B Gas Vent

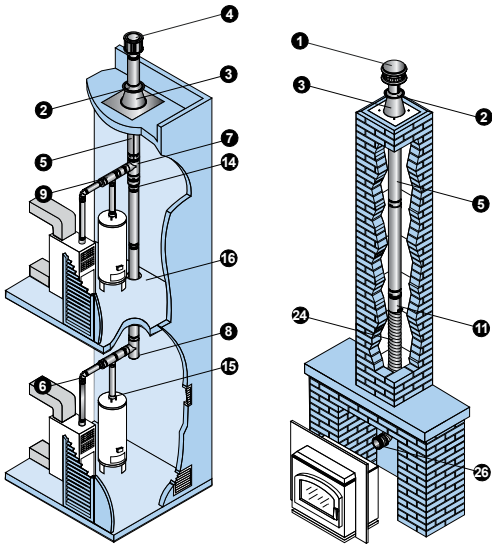

Multi-Story

Gas Insert To Masonry

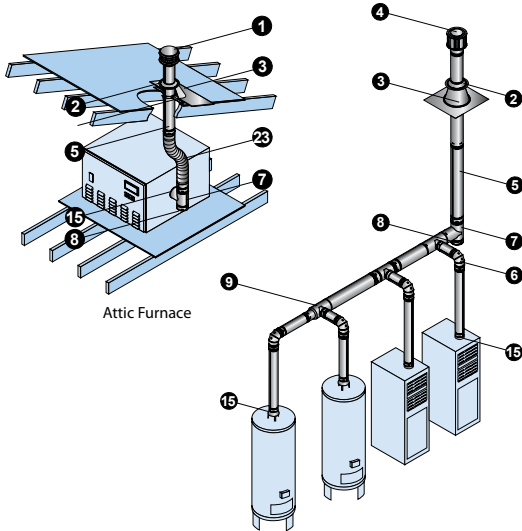

Attic Furnace

Type B Gas Vent Manifold

Installation Key			
1	DuraCap	14	Increaser
2	Storm Collar	15	Draft Hood Connector
3	Roof Flashing	16	Square Firestop Support
4	High-Wind Cap	17	Oval Pipe
5	Round Pipe	18	Oval to Round Adapter
6	Elbow	19	Oval Tee
7	Tee	20	Oval Tee Cap
8	Tee Cap	21	Oval Tee Support
9	Increaser Tee	22	Oval Firestop Spacer
10	Female Flex Adapter	23	DuraConnect II
11	Male Adapter	24	DuraFlex AL Length
12	Double-Wall Wye	25	DuraFlex Motar Sleeve
13	Pipe Collar	26	DuraFlex AL Coupling

Refer to our Typical Venting Installation drawings to select the appropriate component parts for your installation.

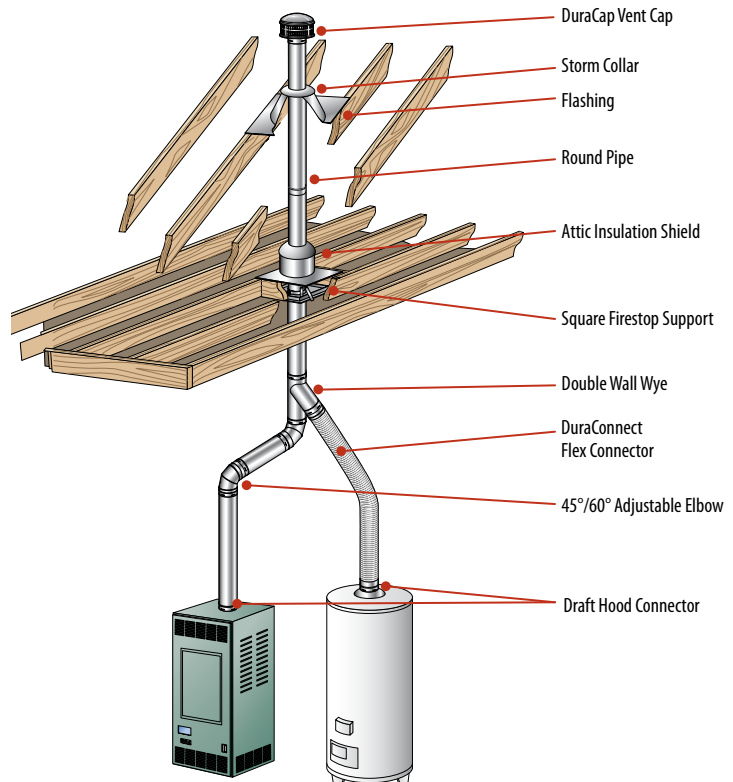

## How Size and Height Affect Stove Performance

- The amount of heat the vent gases lose as they flow determines how much condensation will occur and how strong the draft will be. To control the heat losses, proper selection of venting materials is of vital importance.
- Double-wall Type B Gas Vent, with an aluminum inner wall and a galvanized steel outer wall, has proven to be the ideal choice in venting materials.
- A Type B Gas Vent Sizing Handbook is available to assist you with the proper installation. View online at [www.duravent.com](http://www.duravent.com), under catalogs and instructions.

## Vent Termination Chart

Using listed Type B Gas Vent caps may terminate in accordance with this table.

Roof Pitch	Minimum Height	
	Feet	Meters
Flat to 7/12	1	0.30
Over 7/12 to 8/12	1.5	0.46
Over 8/12 to 9/12	2	0.61
Over 9/12 to 10/12	2.5	0.76
Over 10/12 to 11/12	3.25	0.99
Over 11/12 to 12/12	4	1.22
Over 12/12 to 14/12	5	1.52
Over 14/12 to 16/12	6	1.83
Over 16/12 to 18/12	7	2.13
Over 18/12 to 20/12	7.5	2.29
Over 20/12 to 21/12	8	2.44

## Gas Vent Specification Chart

Item	Clearances	Maximum Height	Outer Tube Ø	Materials	Locking Device	UL Listing	ULC Listing
Type B Vent Round 3"-8"	1 inch to combustibles	100 feet	5/8" larger than ID	Inner - .012" Aluminum Outer - .018" Galvanized	DuraLock	MH6357	CMH1276
Round 10" to 16" See note 2	1 inch to combustibles	100 feet	1" larger than ID	Inner - .016" Aluminum Outer - .021" Galvanized	TwistLock Screws	MH6357	CMH1276
Round 18" to 30"	1 inch to combustibles	100 feet	2" larger than ID See note 5	Inner - .020" Aluminum Outer - .021" Galvanized	Screws	MH6357	CMH1276
Oval Type B Vent 4" and 5"	2" x 4" & 2" x 6" stud wall and 1 inch to combustibles	See Note 3	2 1/2" x 7 1/4" 3 1/8" x 10 7/8"	Inner - .012" Aluminum Outer - .018" Galvanized	Button Lock	MH6357	CMH1276
Oval Type B Vent 6"	2" x 6" stud wall and 1 inch to combustibles	See Note 3	3 1/4" x 12"	Inner - .012" Aluminum Outer - .018" Galvanized	Button Lock	MH6357	CMH1276
Type B Vent 3" to 6" Round Liner	0"/Masonry	50 feet	5/8" larger than ID	Inner - .012" Aluminum Outer - .018" Galvanized	DuraLock	MH14420 MH6357	CMH1407
DuraFlex AL Gas Relining 3" to 6"	0"/Masonry	50 feet	1/4" larger than ID	.010" Aluminum Flex	Screws DuraLock	MH14420	--
DuraConnect 3" to 6"	1 inch to combustibles	See Note 4	1/4" larger than ID	.010" Aluminum Flex .018" Galvalume	DuraLock	MH14089	--
DuraConnect II 3" to 6"	1 inch to combustibles	See Note 4	1/4" larger than ID	.010" Aluminum Flex .018" Galvalume	DuraLock	MH14089	--

NOTES
1. Clearance to combustibles is the air space between vent and combustibles.
2. Maximum height varies with equipment over 50', for taller applications refer to SDV sizing handbook (L202). 14"-16" Pipe require screws.
3. When oval is used on wall furnaces, minimum height required from bottom of furnace to cap is 12', minimum 16" stud space.
4. Limited by sizing tables.
5. 18" pipe OD is one inch larger than ID and 20" - 30" OD is 2" greater than ID.

# Round Type B Gas Vent

## Round Rigid Pipe

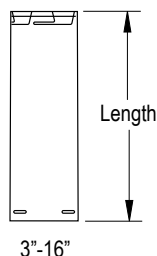

Use for venting listed natural gas or liquid propane Category I, draft hood appliances, or appliances that have been specifically tested and listed to use Type B Gas Vent. The appliances listed typically use Type B Gas Vent systems, but not always: Furnaces, Water Heaters, Boilers, Room Heaters, Decorative Gas Appliances, and Unit Heaters.

To calculate installed length, subtract 1 1/2" from each connection of vent. A 1" clearance (air space) to combustibles must be maintained. To calculate OD add 5/8".

SIZE	LENGTH	ORDER #	STOCK #	SIZE	LENGTH	ORDER #	STOCK #
3"	6"	3GV06	0040	6"	6"	6GV06	0043
3"	12"	3GV12	0030	6"	12"	6GV12	0033
3"	18"	3GV18	0020	6"	18"	6GV18	0023
3"	24"	3GV24	0385	6"	24"	6GV24	0388
3"	36"	3GV36	0010	6"	36"	6GV36	0013
3"	48"	3GV48	0400	6"	48"	6GV48	0403
3"	60"	3GV60	0001	6"	60"	6GV60	0004
4"	6"	4GV06	0041	7"	6"	7GV06	0044
4"	12"	4GV12	0031	7"	12"	7GV12	0034
4"	18"	4GV18	0021	7"	18"	7GV18	0024
4"	24"	4GV24	0386	7"	24"	7GV24	0389
4"	36"	4GV36	0011	7"	36"	7GV36	0014
4"	48"	4GV48	0401	7"	48"	7GV48	0404
4"	60"	4GV60	0002	7"	60"	7GV60	0005
5"	6"	5GV06	0042	8"	12"	8GV12	0035
5"	12"	5GV12	0032	8"	18"	8GV18	0025
5"	18"	5GV18	0022	8"	24"	8GV24	0390
5"	24"	5GV24	0387	8"	36"	8GV36	0015
5"	36"	5GV36	0012	8"	48"	8GV48	0405
5"	48"	5GV48	0402	8"	60"	8GV60	0006
5"	60"	5GV60	0003				

Type B Gas Vent systems may be used on other gas-burning appliances, when specified by appliance manufacturer. Type B Gas Vent is not used for Category II, III, or IV gas appliances, unless specified by appliance manufacturer.

## Large Diameter Round Rigid Pipe

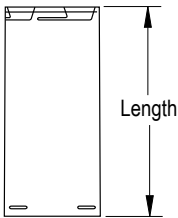

10"-16"

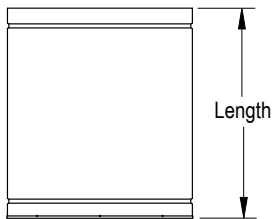

18"-30"

To calculate installed length, subtract 1 1/2" (for 10"-16" diameter) and 1 1/8" (for 18"-30" diameter) from each connection of vent. A 1" clearance (air space) to combustibles materials must be maintained. 18"-30" diameters are built to order and can not be returned.

SIZE	LENGTH	ORDER #	STOCK #	O.D.
10"	18"	10GV18	2426	11"
10"	36"	10GV36	2516	11"
12"	18"	12GV18	2427	13"
12"	36"	12GV36	2517	13"
14"	18"	14GV18	2520	15"
14"	36"	14GV36	2500	15"
16"	18"	16GV18	2521	17"
16"	36"	16GV36	2501	17"
18"	18"	18GV18	2522	20"
18"	36"	18GV36	2502	20"
20"	18"	20GV18	2523	22"
20"	36"	20GV36	2503	22"
22"	18"	22GV18	2524	24"
22"	36"	22GV36	2504	24"
24"	18"	24GV18	2525	26"
24"	36"	24GV36	2505	26"
26"	18"	26GV18	2526	28"
26"	36"	26GV36	2506	28"
28"	18"	28GV18	2527	30"
28"	36"	28GV36	2507	30"
30"	18"	30GV18	2528	32"
30"	36"	30GV36	2508	32"

## Flex Pipe

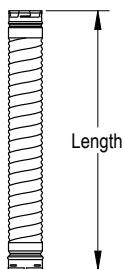

Use for offsets when relining a masonry chimney with DuraVent Type B Gas Vent. Add 5/8" for OD.

SIZE	LENGTH	ORDER #	STOCK #
4"	5'	4GV60F	0002F
5"	5'	5GV60F	0003F
6"	5'	6GV60F	0004F



### Round Adjustable Pipe

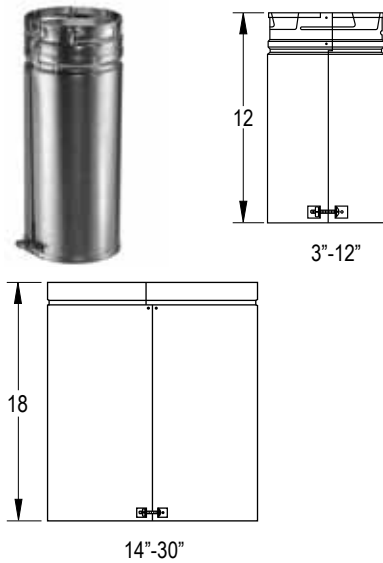

Use to add length to a straight length of Type B Gas Vent. 12" adds 3"-10" of length, 18" adds 10"-16" of length. Requires a 2" overlap.

SIZE	LENGTH	ORDER #	STOCK #	SIZE	LENGTH	ORDER #	STOCK #
3"	3" - 10"	3GV12A	0050	16"	10" - 16"	16GV18A	2671
4"	3" - 10"	4GV12A	0051	18"	10" - 16"	18GV18A	2672
5"	3" - 10"	5GV12A	0052	20"	10" - 16"	20GV18A	2673
6"	3" - 10"	6GV12A	0053	22"	10" - 16"	22GV18A	2674
7"	3" - 10"	7GV12A	0054	24"	10" - 16"	24GV18A	2675
8"	3" - 10"	8GV12A	0055	26"	10" - 16"	26GV18A	2676
10"	3" - 10"	10GV12A	2456	28"	10" - 16"	28GV18A	2677
12"	3" - 10"	12GV12A	2457	30"	10" - 16"	30GV18A	2678
14"	10" - 16"	14GV18A	2670				

### DuraConnect II - Double-Wall Flex Connector

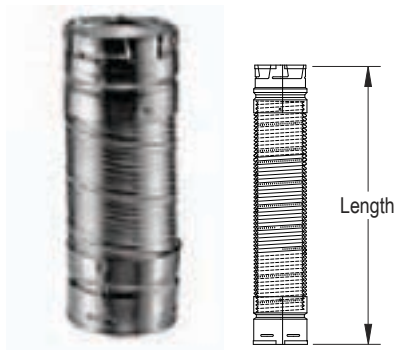

Use as a connector system to replace rigid gas vent with a flexible section. DuraConnect II can be used when Type B gas vent double-wall connector is required. Not to be enclosed and cannot penetrate through walls, floors, or ceilings. Twist-lock connectors on each end.

SIZE	LENGTH	ORDER #	STOCK #
3"	12"	3DV12DW	6505
3"	24"	3DV24DW	6504
3"	36"	3DV36DW	6503
3"	48"	3DV48DW	6502
3"	60"	3DV60DW	6501
4"	12"	4DV12DW	6605
4"	24"	4DV24DW	6604
4"	36"	4DV36DW	6603
4"	48"	4DV48DW	6602
4"	60"	4DV60DW	6601
5"	12"	5DV12DW	6705
5"	24"	5DV24DW	6704
5"	36"	5DV36DW	6703
5"	48"	5DV48DW	6702
5"	60"	5DV60DW	6701

### 90° Adjustable Elbow

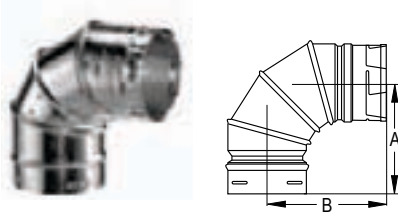

Offsets obstructions as needed. Elbows (3"-8") swivel 360° at base. 90° Elbow is adjustable from 0° to 90° in sizes 3"-10". Elbows must be supported when installed.

SIZE	ORDER #	STOCK #	A	B
3"	3GVL90	0060	5 1/2"	5 1/4"
4"	4GVL90	0061	6"	5 1/2"
5"	5GVL90	0062	6 1/2"	6 1/2"
6"	6GVL90	0063	6 3/4"	6 3/4"
7"	7GVL90	0064	7 3/4"	7 1/2"
8"	8GVL90	0065	7 3/4"	7 1/2"
10"	10GVL90	2466	10 1/4"	9 5/8"

### 45°/60° Adjustable Elbow

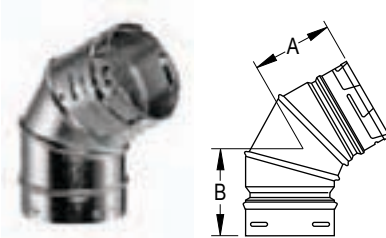

Offsets obstructions as needed. Elbows swivel 360° at base. 45°/60° Elbow is adjustable from 0° to 60°. Elbows must be supported when installed.

SIZE	ORDER #	STOCK #	A	B
3"	3GVL45	0070	4"	4"
4"	4GVL45	0071	4 1/2"	4 1/2"
5"	5GVL45	0072	4 1/2"	4 1/2"
6"	6GVL45	0073	5"	5"

### 45° Elbow

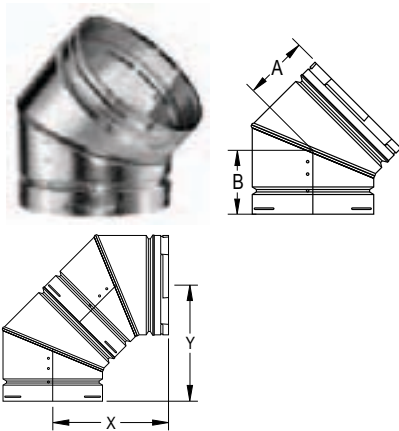

90° offset using two 45° Elbows

Offsets obstructions as needed. 45° Elbow in size 7"-30". Elbows up to 10" are adjustable. Sizes 12" and larger are not adjustable. Elbows must be supported when installed.

SIZE	ORDER #	STOCK #	A	B	X	Y
7"	7GVL45	0074	4 3/4"	4 3/4"	10 1/2"	10 1/2"
8"	8GVL45	0075	4 3/4"	4 3/4"	10 1/4"	10 1/4"
10"	10GVL45	2476	5 1/2"	5 3/4"	--	--
12"	12GVL45	2477	6 1/8"	6 1/4"	13 7/8"	14"
14"	14GVL45	2550	6 1/2"	6 7/8"	14 7/8"	15 1/4"
16"	16GVL45	2551	7 1/4"	7 3/8"	16 1/2"	16 1/2"
18"	18GVL45	2552	9"	8 1/2"	20 1/8"	21 7/8"
20"	20GVL45	2553	9"	8 3/8"	20 1/4"	21 3/4"
22"	22GVL45	2554	8 1/2"	9 3/4"	20 3/8"	21 5/8"
24"	24GVL45	2555	9 1/2"	9 3/4"	21"	21 7/8"
26"	26GVL45	2556	10 1/4"	10 1/4"	21 1/2"	22 3/4"
28"	28GVL45	2557	9 3/4"	10"	21 1/2"	22 3/4"
30"	30GVL45	2558	9 3/4"	10"	23 3/4"	24"

### Standard Tee

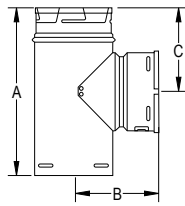

Use for a 90° offset or to combine connectors from two or more appliances into a common vent. Branch swivels for alignment. 3"-8" feature swivel on male end.

SIZE	ORDER #	STOCK #	A	B	C
3"	3GVT	0080	9"	4 1/2"	4 1/4"
4"	4GVT	0081	9 7/8"	4 3/4"	4 3/4"
5"	5GVT	0082	11"	5 1/2"	5 1/4"
6"	6GVT	0083	12"	5 3/4"	5 5/8"
7"	7GVT	0084	13"	6 5/16"	6 1/4"
8"	8GVT	0085	14"	7 3/8"	7"
10"	10GVT	2586	17 1/2"	8 1/2"	8 3/4"
12"	12GVT	2587	19 3/4"	10"	9 3/8"
14"	14GVT	2540	20 7/8"	11"	10 1/2"
16"	16GVT	2541	24 1/2"	12 1/4"	12 1/4"
18"	18GVT	2542	29"	15"	15"
20"	20GVT	2543	32"	16"	16"
22"	22GVT	2544	33"	17"	17"
24"	24GVT	2545	35"	18"	18"
26"	26GVT	2546	35 1/2"	18 1/2"	17 3/4"
28"	28GVT	2547	36"	19"	18 1/2"
30"	30GVT	2548	41 1/2"	20 1/2"	20 3/4"

### Increaser Tee

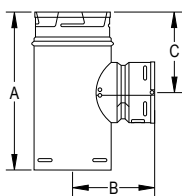

Attaches smaller pipe to branch and larger pipe to body. Use for a 90° offset or to combine connectors from two or more appliances into a common vent. Branch swivels for alignment. Swivel on male end. Additional sizes available through special order.

SIZE	ORDER #	STOCK #	A	B	C
4" x 3"	4GVTR3	0081T3	9"	4 13/16"	4 3/8"
5" x 4"	5GVTR4	0082T4	9 3/4"	5 1/2"	4 3/4"
5" x 3"	5GVTR3	0082T3	8 7/8"	5 1/2"	4"
6" x 4"	6GVTR4	0083T4	9 3/4"	6"	5 1/2"
6" x 3"	6GVTR3	0083T3	8 3/4"	6"	4"

### Tee Cap

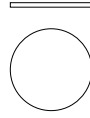

Use to cap Standard Tee or Increaser Tee. Remove Tee Cap to inspect the system; clean out debris or collected condensate from the common vent. Fits on inner liner.

SIZE	ORDER #	STOCK #
3"	3GVTC	0090
4"	4GVTC	0091
5"	5GVTC	0092
6"	6GVTC	0093
7"	7GVTC	0094
8"	8GVTC	0095
10"	10GVTC	2596
12"	12GVTC	2597
14"	14GVTC	2690
16"	16GVTC	2691
18"	18GVTC	2692
20"	20GVTC	2693
22"	22GVTC	2694
24"	24GVTC	2695
26"	26GVTC	2696
28"	28GVTC	2697
30"	30GVTC	2698

### Double-Wall Wye - 45° Branch

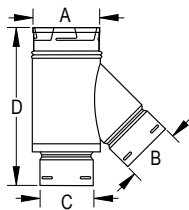

Use to combine connectors from two or more appliances into a common vent. Branch swivels for alignment. Swivel on male end. Additional sizes available through special order.

SIZE	ORDER #	STOCK #	A	B	C	D
4" x 4" x 3"	4GVY43	0425	4 1/2"	4 5/8"	3 5/8"	13 7/8"
4" x 4" x 4"	4GVY44	0426	4 1/2"	4 5/8"	4 5/8"	13 7/8"
4" x 3" x 4"	4GVY34	0427	4 1/2"	3 5/8"	4 5/8"	10 3/4"
5" x 3" x 4"	5GVY34	0430	5 1/2"	3 5/8"	4 5/8"	12 1/4"
5" x 4" x 4"	5GVY44	0431	5 1/2"	4 5/8"	4 5/8"	14"
5" x 4" x 5"	5GVY45	0432	5 1/2"	4 5/8"	5 5/8"	12"
6" x 3" x 4"	6GVY34	0440	6 1/2"	3 5/8"	4 5/8"	12 5/8"
6" x 4" x 3"	6GVY43	0441	6 1/2"	4 5/8"	3 5/8"	13 1/2"
6" x 4" x 4"	6GVY44	0442	6 1/2"	4 5/8"	4 5/8"	14"
6" x 4" x 5"	6GVY45	0443	6 1/2"	4 5/8"	5 5/8"	13 1/4"
6" x 3" x 5"	6GVY35	0445	6 1/2"	3 5/8"	5 5/8"	13 1/4"
6" x 4" x 6"	6GVY46	0446	6 1/2"	4 5/8"	6 5/8"	12"
7" x 3" x 5"	7GVY35	0450	7 1/2"	3 5/8"	5 5/8"	12 1/4"

### Draft Hood Connector

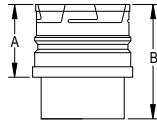

Use to connect appliance or single-wall connector to vent system.

SIZE	ORDER #	STOCK #	A	B
3"	3GVC	0120	3"	6"
4"	4GVC	0121	3"	6"
5"	5GVC	0122	3"	6"
6"	6GVC	0123	3"	6"
7"	7GVC	0124	3"	6"
8"	8GVC	0125	3"	6"
10"	10GVC	2626	4"	7 3/8"
12"	12GVC	2627	4"	7 3/8"
14"	14GVC	2590	6"	10"
16"	16GVC	2591	5 3/4"	10"
18"	18GVC	2592	6"	12"
20"	20GVC	2593	6"	12"
22"	22GVC	2594	6"	14 3/4"
24"	24GVC	2595	6"	14"

### Increaser

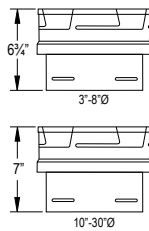

Use to increase vent diameter. Additional sizes available through special order. \*\*Specified diameter (i.e.: 6GVX10).

SIZE	ORDER #	STOCK #	SIZE	ORDER #	STOCK #
3" x 4"	3GVX4	0100S	7" x 8"	7GVX8	0108S
3" x 5"	3GVX5	0101S	** x 10"	**GVX10	2409
3" x 6"	3GVX6	0102S	** x 12"	**GVX12	2511
3" x 7"	3GVX7	0112S	** x 14"	**GVX14	2509
4" x 5"	4GVX5	0103S	** x 16"	**GVX16	2519
4" x 6"	4GVX6	0104S	** x 18"	**GVX18	2529
4" x 7"	4GVX7	0113S	** x 20"	**GVX20	2539
4" x 8"	4GVX8	0116S	** x 22"	**GVX22	2549
5" x 6"	5GVX6	0105S	** x 24"	**GVX24	2559
5" x 7"	5GVX7	0115S	** x 26"	**GVX26	2569
5" x 8"	5GVX8	0117S	** x 28"	**GVX28	2579
6" x 7"	6GVX7	0106S	** x 30"	**GVX30	2589
6" x 8"	6GVX8	0107S			

### Draft Hood Increaser

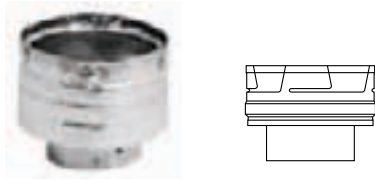

Use to increase the vent diameter directly on top of the appliance.

SIZE	ORDER #	STOCK #
3" - 4"	3GVRRA4	0187C
3" - 5"	3GVRRA5	0188C
4" - 5"	4GVRRA5	0178C

### Female Adapter

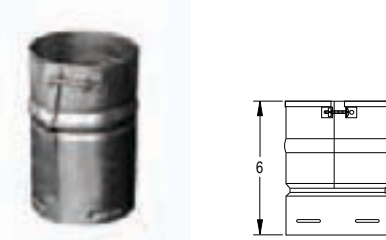

Use to connect listed Type B Gas Vent system manufactured by other companies to existing DuraVent Type B Gas Vent. For adapting to flex see DuraFlex Female Flex Adapter.

SIZE	ORDER #	STOCK #
3"	3GVAF	0496
4"	4GVAF	0497
5"	5GVAF	0498
6"	6GVAF	0499
7"	7GVAF	0488
8"	8GVAF	0495

### Male Adapter

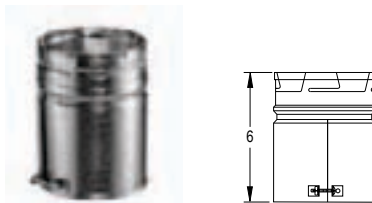

Use to connect existing DuraVent Type B Gas Vent to a listed Type B Gas Vent system manufactured by other companies. Male adapter can also be used to attach to DuraFlex AL.

SIZE	ORDER #	STOCK #
3"	3GVAM	0490
4"	4GVAM	0491
5"	5GVAM	0492
6"	6GVAM	0493
7"	7GVAM	0487
8"	8GVAM	0494

### H/C Adapter



Use to connect DuraVent Type B Gas Vent products to an existing listed Type B Gas Vent system, manufactured by other companies using locking ring system.

SIZE	STOCK #
3"	0496H
4"	0497H
5"	0498H
6"	0499H

### Wall Strap

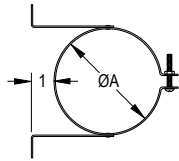

Use to provide support for offsets and horizontal runs. Recommended every 4' to support vertical common vent. Use also with DuraConnect or DuraConnect II. 10" Type B gas vent (11" OD) uses a 7" DuraPlus Chimney Wall Strap. Wall Strap legs can be rotated 360° to conceal screw.

SIZE	ORDER #	STOCK #	A
3"	3GVWS	1485	3 5/8"
4"	4GVWS	1486	4 5/8"
5"	5GVWS	1487	5 5/8"
6"	6GVWS	1488	6 5/8"
7"	7GVWS	1489	7 5/8"
8"	8GVWS	1490	8 5/8"
10"	--	9168	10 5/8"

### Square Firestop Support

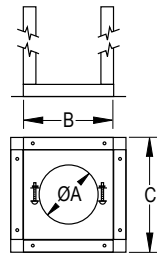

Use to support vent at ceiling level. Includes clamp that supports and prevents pipe sections from slipping down. Provides the mandatory 1" clearance to combustibles. Straps extend 16".

SIZE	ORDER #	STOCK #	A	B	C
3"	3GVRS	1440	3 3/4"	5 3/4"	7 3/4"
4"	4GVRS	1441	4 3/4"	6 3/4"	8 3/4"
5"	5GVRS	1442	5 3/4"	7 3/4"	9 3/4"
6"	6GVRS	1443	6 3/4"	8 3/4"	10 3/4"
7"	7GVRS	1444	7 3/4"	9 3/4"	11 3/4"
8"	8GVRS	1445	8 3/4"	10 3/4"	12 3/4"
10"	10GVRS	2620	10 3/4"	12 3/4"	14 3/4"
12"	12GVRS	2622N	12 3/4"	14 3/4"	16 3/4"

### Gas Vent Roof Support

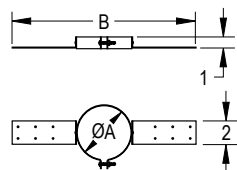

Use to support Type B gas vent pipe at roof level. Can be used when DuraConnect II is installed in attic space.

SIZE	ORDER #	STOCK #	A	B
3"	3GVS	1470	3 5/8"	14 3/4"
4"	4GVS	1471	4 5/8"	15 3/4"
5"	5GVS	1472	5 5/8"	16 3/4"
6"	6GVS	1473	6 5/8"	17 3/4"

### Firestop Spacer

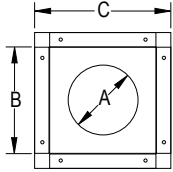

Use at every ceiling level where Square Firestop Support is not used. 3"-6" style shown in left photo. 7"-12" style shown in right photo.

SIZE	ORDER #	STOCK #	A	B	C
3"	3GVFS	1460N	3 3/4"	5 3/4"	7 3/4"
4"	4GVFS	1461N	4 3/4"	6 3/4"	8 3/4"
5"	5GVFS	1462N	5 3/4"	7 3/4"	9 3/4"
6"	6GVFS	1463N	6 3/4"	8 3/4"	10 3/4"
7"	7GVFS	1464N	7 3/4"	9 3/4"	11 3/4"
8"	8GVFS	1465N	8 3/4"	10 3/4"	12 3/4"
10"	10GVFS	2621N	10 3/4"	12 3/4"	14 3/4"
12"	12GVFS	2623	12 3/4"	14 3/4"	16 3/4"

### Round Bucket Support

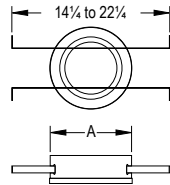

Use to support the Type B gas vent between 16" to 24" on-center joists or rafters. Use with a Draft Hood Connector to transition fitting between single-wall connector and Type B gas vent pipe sections. A Firestop Spacer is required.

SIZE	ORDER #	STOCK #	A
3"- 4"	3GVRS4	0340	7"
5"- 6"	5GVRS6	0342	8"
7"- 8"	7GVRS8	0344	10"

### Pipe Collar

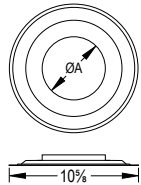

Use for decorative purposes. Optional.

SIZE	ORDER #	STOCK #	A
3"	3GVPC	0170	3 3/4"
4"	4GVPC	0171	4 3/4"
5"	5GVPC	0172	5 3/4"
6"	6GVPC	0173	6 3/4"



### Wall Thimble

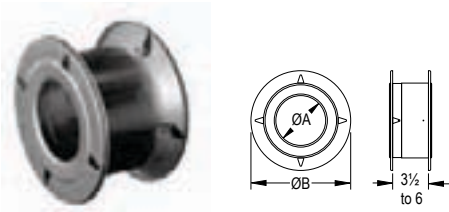

Use for through-the-wall system to provide clearances for vent from combustibles. Adjusts from 3½" to 6" to accommodate various wall thicknesses. Larger diameter wall thimbles are field-fabricated. (See local codes for guidelines.)

SIZE	ORDER #	STOCK #	A	B
3"	3GVWT	0160	3 ¾"	7 ½"
4"	4GVWT	0161	4 ¾"	8 ½"
5"	5GVWT	0162	5 ¾"	9 ½"
6"	6GVWT	0163	6 ¾"	10 ½"
7"	7GVWT	0164	7 ¾"	11 ½"
8"	8GVWT	0165	8 ¾"	12 ½"

### Attic Insulation Shield

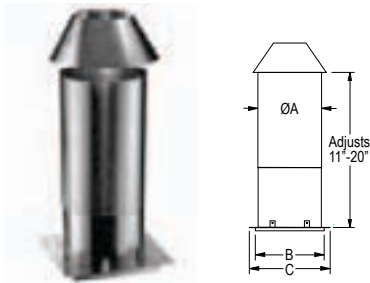

Required for installations that pass through an attic to prevent insulation and debris from accumulating near the vent.

SIZE	STOCK #	A	B	C
3" - 4"	0354	6 ¾"	7 ¾"	9 ¼"
5" - 6"	0355	8 ¾"	8 ½"	11"
7" - 8"	0356	10 ¾"	10 ½"	13"

### Storm Collar

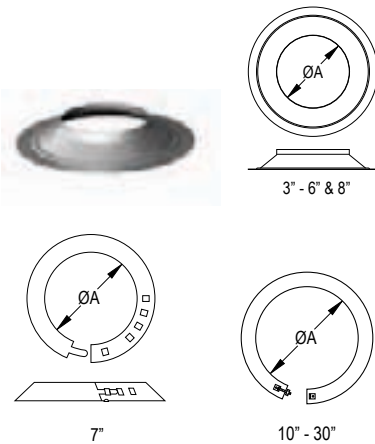

Use to maintain a weather tight resistant seal between the pipe and the flashing.

SIZE	ORDER #	STOCK #	A	SIZE	ORDER #	STOCK #	A
3"	3GVSC	0150	3 ⅝"	16"	16GVSC	2571	18"
4"	4GVSC	0151	4 ⅝"	18"	18GVSC	2572	20"
5"	5GVSC	0152	5 ⅝"	20"	20GVSC	2573	22"
6"	6GVSC	0153	6 ⅝"	22"	22GVSC	2574	24"
7"	7GVSC	0154	7 ⅝"	24"	24GVSC	2575	26"
8"	8GVSC	0155	8 ⅝"	26"	26GVSC	2576	28"
10"	10GVSC	2656	11"	28"	28GVSC	2577	30"
12"	12GVSC	2657	13"	30"	30GVSC	2578	32"
14"	14GVSC	2570	16"				

### Adjustable Roof Flashing

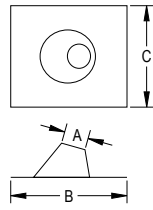

Use to weather proof the penetration of vent pipe through the roof. Storm Collar required. Select roof flashing based on pitch of roof. For pitches of 0/12 - 6/12. Made of galvalume.

SIZE	ORDER #	STOCK #	A	B	C
3"	3GVF	0140	3 5/8"	16"	16"
4"	4GVF	0141	4 5/8"	17"	17"
5"	5GVF	0142	5 5/8"	18 3/8"	18 3/8"
6"	6GVF	0143	6 3/4"	19 1/4"	19 1/4"
7"	7GVF	0144	7 3/4"	21 1/2"	21 1/2"
8"	8GVF	0145	8 3/4"	21 1/2"	21 1/2"
10"	10GVF	2646	11 3/8"	28"	26"
12"	12GVF	2647	13 1/2"	24"	26"
14"	14GVF	2580	15"	29 1/2"	29 1/2"
16"	16GVF	2581	17"	34"	33 1/2"
18"	18GVF	2582	20"	41"	40"
20"	20GVF	2583	22"	41"	40"
22"	22GVF	2584	24"	43"	41 1/2"
24"	24GVF	2585	26"	43"	44 3/4"
26"	26GVF	2686	28"	42 3/4"	44 3/4"
28"	28GVF	2687	30"	48"	50"
30"	30GVF	2688	32"	50"	52"

### Steep Roof Flashing

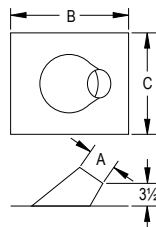

Use to weather proof the penetration of vent pipe through the roof. Storm Collar required. Select roof flashing based on pitch of roof. For pitches of 7/12 - 12/12. Made of galvalume.

SIZE	ORDER #	STOCK #	A	B	C
3"	3GVFSR	0140S	3 3/4"	14"	18"
4"	4GVFSR	0141S	4 3/4"	15"	20"
5"	5GVFSR	0142S	5 3/4"	16"	21 3/4"
6"	6GVFSR	0143S	6 3/4"	17 1/2"	23 3/4"
7"	7GVFSR	0144S	7 3/4"	18 1/2"	24"
8"	8GVFSR	0145S	8 3/4"	19"	25 1/2"

### Tall Cone Flat Flashing

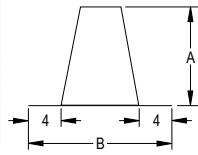

Use to weather proof the penetration of vent pipe through the roof. Storm Collar required. Select roof flashing based on pitch of roof. Use on flat roofs, chase enclosures, or masonry chimney. Made of galvalume.

SIZE	ORDER #	STOCK #	A	B
3"	3GVFF	0140F	11 1/4"	16"
4"	4GVFF	0141F	11 1/4"	17"
5"	5GVFF	0142F	11 1/4"	18 1/4"
6"	6GVFF	0143F	10 7/8"	18 1/4"
7"	7GVFF	0144F	11 1/4"	21 1/2"
8"	8GVFF	0145F	11 1/4"	21 1/2"
10"	10GVFF	2646F	11 1/4"	25 1/2"
12"	12GVFF	2647F	12"	29 1/2"
14"	14GVFF	2580F	12"	32"
16"	16GVFF	2581F	12"	36"
18"	18GVFF	2582F	12"	36"
20"	20GVFF	2583F	12"	38"
22"	22GVFF	2584F	12"	40"
24"	24GVFF	2585F	12"	44 3/4"
26"	26GVFF	2686F	12"	44 3/4"
28"	28GVFF	2687F	12"	48"
30"	30GVFF	2688F	12"	48"

### DSA Roof Flashing

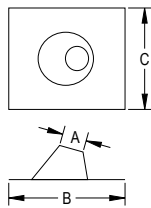

Use with metal or tile roofs. Available in Adjustable Roof Flashing style (0/12-6/12). Made of dead soft aluminum. Refer to Roof Flashing tables for dimensions.

SIZE	ORDER #	STOCK #	A	B	C
3"	3GVFDSA	0140DS	3 5/8"	19 3/8"	23"
4"	4GVFDSA	0141DS	4 5/8"	19 3/8"	23"
5"	5GVFDSA	0142DS	5 5/8"	22"	24 13/16"
6"	6GVFDSA	0143DS	6 3/4"	22"	24 13/16"

### DuraCap

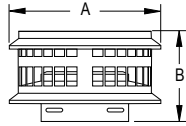

Required where pipe terminates above the roof line. Use for vertical installations only.

SIZE	ORDER #	STOCK #	A	B
3"	3GVDC	0630	8"	5"
4"	4GVDC	0631	8"	5"
5"	5GVDC	0632	11"	7 1/2"
6"	6GVDC	0633	11"	7 1/2"
7"	7GVDC	0634	15"	7 1/4"
8"	8GVDC	0635	15"	7 1/4"

### High-Wind Cap

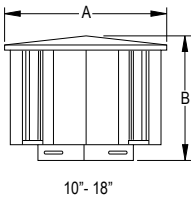
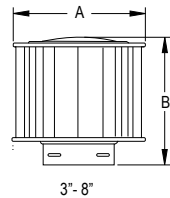

10" - 18"

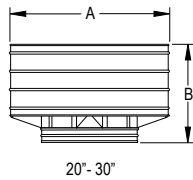

20" - 30"

Use for vertical terminations only. Provides improved performance in high wind conditions. For vertical terminations only.

SIZE	ORDER #	STOCK #	A	B
3"	3GVVTH	0130	7 1/2"	7 1/4"
4"	4GVVTH	0131	8 1/2"	8 1/4"
5"	5GVVTH	0132	9 1/2"	9 3/8"
6"	6GVVTH	0133	10 1/2"	9 1/4"
7"	7GVVTH	0134	11 1/2"	11 3/4"
8"	8GVVTH	0135	12 1/2"	12 3/4"
10"	10GVVT	2536	17 1/2"	16"
12"	12GVVT	2537	19 1/4"	18 3/4"
14"	14GVVT	2560	24"	23"
16"	16GVVT	2561	26"	19 1/2"
18"	18GVVT	2562	30"	21 1/2"
20"	20GVVT	2563	34"	23 1/2"
22"	22GVVT	2564	36"	25 1/2"
24"	24GVVT	2565	39"	27 1/2"
26"	26GVVT	2566	44"	29 1/2"
28"	28GVVT	2567	48"	31 1/2"
30"	30GVVT	2568	50"	33 1/2"

# Oval Type B Gas Vent

## Oval Installation Kit



Kit includes: Oval Base Plate and (2) Oval Ceiling Plate Spacers.

Use for wall furnaces installed in a single-story application.

SIZE	ORDER #	STOCK #
4"	4GWK	0319

## Oval Rigid Pipe

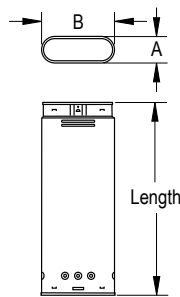

Use for venting listed natural gas or liquid propane Category I, draft hood appliances, or appliances that have been specifically tested and listed to use Type B Gas Vent. The appliances listed typically use Type B Gas Vent systems, but not always: Furnaces, Water Heaters, Boilers, Room Heaters, Decorative Gas Appliances, and Unit Heaters. Designed to be placed within 2" x 4" stud walls (4" and 5" oval pipe). 6" may only be placed in a 2" x 6" 16" O.C. stud space.

SIZE	LENGTH	ORDER #	STOCK #	A	B
4"	6"	4GW06	0305	2 1/2"	7 1/4"
4"	12"	4GW12	0304	2 1/2"	7 1/4"
4"	18"	4GW18	0303	2 1/2"	7 1/4"
4"	24"	4GW24	0307	2 1/2"	7 1/4"
4"	36"	4GW36	0302	2 1/2"	7 1/4"
4"	48"	4GW48	0301	2 1/2"	7 1/4"
4"	60"	4GW60	0300	2 1/2"	7 1/4"
5"	6"	5GW06	0505	3 1/8"	10 7/8"
5"	12"	5GW12	0504	3 1/8"	10 7/8"
5"	18"	5GW18	0503	3 1/8"	10 7/8"
5"	24"	5GW24	0507	3 1/8"	10 7/8"
5"	36"	5GW36	0502	3 1/8"	10 7/8"
5"	48"	5GW48	0501	3 1/8"	10 7/8"
5"	60"	5GW60	0500	3 1/8"	10 7/8"
6"	6"	6GW06	0605	3 1/4"	11 7/8"
6"	12"	6GW12	0604	3 1/4"	11 7/8"
6"	18"	6GW18	0603	3 1/4"	11 7/8"
6"	24"	6GW24	0607	3 1/4"	11 7/8"
6"	36"	6GW36	0602	3 1/4"	11 7/8"
6"	48"	6GW48	0601	3 1/4"	11 7/8"
6"	60"	6GW60	0600	3 1/4"	11 7/8"

### Oval Adjustable Pipe

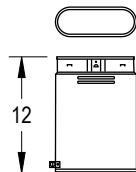

Use to add length to a straight length of Oval Type B Gas Vent Pipe. Adjusts from 4"-10". Requires a 2" overlap.

SIZE	LENGTH	ORDER #	STOCK #
4"	12"	4GW12A	0306
5"	12"	5GW12A	0506
6"	12"	6GW12A	0606

### Oval Increaser

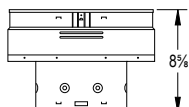

Use to increase oval vent diameter.

SIZE	ORDER #	STOCK #
4" x 5"	4GWX5	0419
5" x 6"	5GWX6	0519
4" x 6"	4GWX6	0619

### Round To Oval Adapter

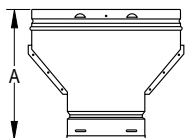

Use to convert from round to oval vent.

SIZE	ORDER #	STOCK #	A
3" to 4"	4GWAR3	0324	9 1/4"
4"	4GWAR0	0315	9 1/4"
5"	5GWAR0	0515	9 3/8"
6"	6GWAR0	0615	11 1/2"

### Oval To Round Adapter

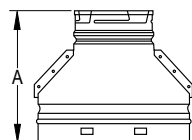

Use to convert from oval to round vent.

SIZE	ORDER #	STOCK #	A
4"	4GWAOR	0314	9 1/4"
5"	5GWAOR	0514	9 7/8"
6"	6GWAOR	0614	10"

### Oval 45° Elbow - Standard

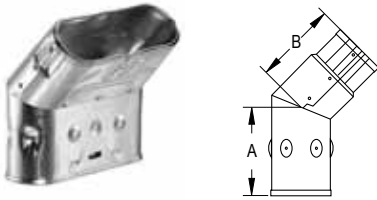

Offsets obstructions as needed. Not adjustable.

SIZE	ORDER #	STOCK #	A	B
4"	4GWL45	0310	3 5/8"	3 1/2"
5"	5GWL45	0510	4 1/8"	5"
6"	6GWL45	0610	5"	5"

### Oval 45° Elbow - Flat

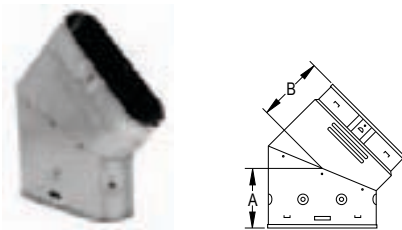

Offsets obstructions as needed. Not adjustable.

SIZE	ORDER #	STOCK #	A	B
4"	4GWL45F	0311	4 1/2"	4 1/8"
5"	5GWL45F	0511	5 1/4"	5 5/8"
6"	6GWL45F	0611	5 3/4"	4 3/4"

### Oval Tee Support - Plain

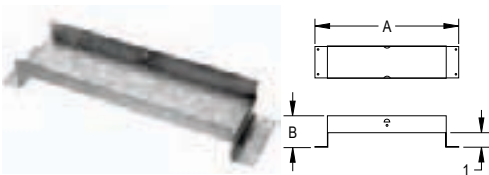

Use to support and center Oval Tee. Use with Oval Tee Cap.

SIZE	ORDER #	STOCK #	A	B
5"	5GWTS	0521	13 7/8"	2 1/8"
6"	6GWTS	0621	13 7/8"	2 1/8"

### Oval Tee Support - Base Plate

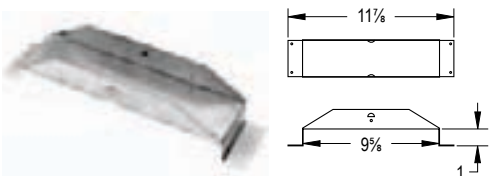

Use to support and center Oval Tee. Use with Oval Tee Cap.

SIZE	ORDER #	STOCK #	A	B
4"	4GWPS	0308	9 5/8"	11 7/8"

### Oval Firestop Spacer

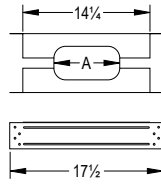

Use to center oval vent in a minimum 16" on-center stud space. Serves as a firestop at the ceiling level. Required in multi-story installations.

SIZE	ORDER #	STOCK #	A
4"	4GWFS	0350	7 1/2"
4"	4GWFS2X6	0351	7 1/2"
5"	5GWFS	0522	11"
5"	5GWFS2X6	0523	11"
6"	6GWFS	0622	12 1/8"

### Oval Base Plate

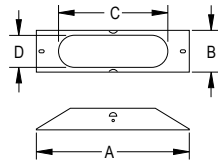

Use to attach oval vent to a wall furnace.

SIZE	ORDER #	STOCK #	A	B	C	D
4"	4GWBP	0321	9 5/8"	2 3/8"	6 7/8"	2"

### Oval Ceiling Plate Spacer

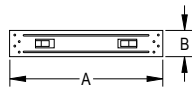

Use to center the oval vent where Oval Firestop Spacer is not required. (2 plates included.)

SIZE	ORDER #	STOCK #	A	B
4"	4GWCS	0320	17 1/2"	3"

### Oval Standard Tee

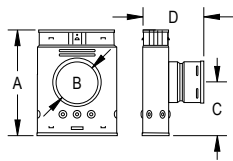

Use to attach round pipe to oval pipe. Use for a 90° offset or to combine connectors from two or more appliances into a common vent.

SIZE	ORDER #	STOCK #	A	B	C	D
4"	4GWT	0312	10 1/4"	4"	5 1/4"	6"
5"	5GWT	0512	11 3/4"	5"	6 1/4"	6 1/4"
6"	6GWT	0612	12 1/8"	6"	6"	7"



### Oval Short Snout Tee

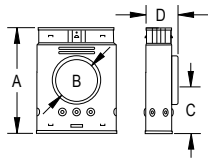

Use to attach round pipe to oval pipe. Use for a 90° offset or to combine connectors from two or more appliances into a common vent. Shorter snout allows installation in tight spaces.

SIZE	ORDER #	STOCK #	A	B	C	D
4"	4GWST	0312ST	8 1/2"	4"	5"	3 1/2"

### Oval Increaser Tee

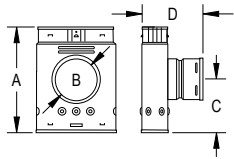

Use to attach smaller round pipe to larger oval pipe. Use for a 90° offset or to combine connectors from two or more appliances into a common vent.

SIZE	ORDER #	STOCK #	A	B	C	D
4" x 3"	4GWTR3	0331	10 1/8"	3"	5"	6 1/2"
5" x 3"	5GWTR3	0512T3	11 7/8"	3"	6 1/4"	7 1/4"
5" x 4"	5GWTR4	0512T4	11 7/8"	4"	6 1/4"	6 3/4"
6" x 4"	6GWTR4	0612T4	12"	4"	5 3/4"	8 1/4"
6" x 5"	6GWTR5	0612T5	12"	5"	5 3/8"	6 7/8"

### Oval Tee Cap

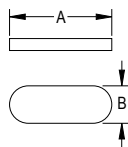

Use to close off bottom of Oval Tee. Fits on inner liner.

SIZE	ORDER #	STOCK #	A	B
4"	4GWTC	0313	6 7/8"	2"
5"	5GWTC	0513	10 3/8"	2 3/4"
6"	6GWTC	0613	11 1/2"	2 3/4"

### Oval Storm Collar

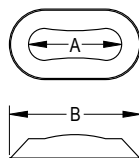

Use to maintain a weather tight resistant seal between the pipe and the flashing.

SIZE	ORDER #	STOCK #	A	B
4"	4GWSC	0318	7 1/2"	10 1/4"
5"	5GWSC	0518	10 3/4"	13 3/8"
6"	6GWSC	0618	12"	15"

### Oval Adjustable Roof Flashing

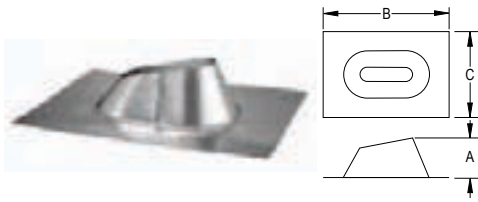

Use to weather proof the penetration of vent pipe through the roof. Storm Collar required. Select roof flashing based on pitch of roof. For pitches of 0/12 - 6/12. Made of galvalume.

SIZE	ORDER #	STOCK #	A	B	C
4"	4GWF	0317	3 1/2"	18"	12 1/2"
5"	5GWF	0517	7 3/4"	25 1/2"	17 1/2"
6"	6GWF	0617	7 1/8"	25 1/2"	17 1/2"

### Oval DSA Roof Flashing

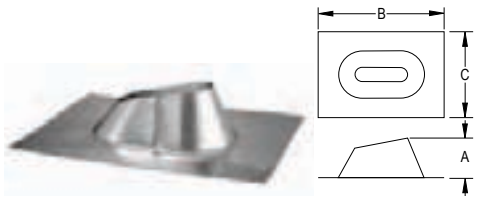

Use with metal or tile roofs. Available in Adjustable Roof Flashing style (0/12-6/12). Made of dead soft aluminum. Refer to Roof Flashing tables for dimensions.

SIZE	ORDER #	STOCK #	A	B	C
4"	4GWFDSA	0317DS	3 3/4"	28 1/2"	23 1/2"
5"	5GWFDSA	0517DS	3 1/2"	30 1/2"	27"
6"	6GWFDSA	0617DS	7"	35"	27"

### Oval Cap

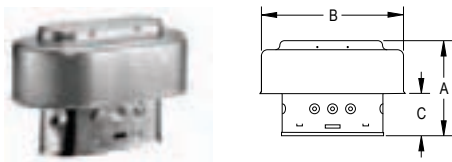

Required where pipe terminates above the roof line. Use for vertical installations only.

SIZE	ORDER #	STOCK #	A	B	C
4"	4GWVT	0316	6 1/8"	10"	2 3/4"
5"	5GWVT	0516	7 1/2"	15 1/4"	3 3/4"
6"	6GWVT	0616	7 1/2"	15 1/4"	4"

## DuraFlex® - Aluminum

### DuraFlex AL Kit



Kit includes: DuraFlex AL Length, DuraFlex AL Cap, DuraFlex Top Plate, and DuraFlex Mortar Sleeve. Flex lengths available in 25' and 35'.

SIZE	25' FLEX	35' FLEX
3"	3DFA-25K	3DFA-35K
4"	4DFA-25K	4DFA-35K
5"	5DFA-25K	5DFA-35K
5 1/2"	55DFA-25K	55DFA-35K
6"	6DFA-25K	6DFA-35K
7"	7DFA-25K	7DFA-35K
8"	8DFA-25K	8DFA-35K

### DuraFlex AL - Aluminum Length



Use with Category I gas-burning appliances with draft hood. UL 1777 aluminum liner. Flex lengths available in 25', 35', and 50'.

SIZE	25' FLEX	35' FLEX	50' FLEX
3"	3DFA-25	3DFA-35	3DFA-50
4"	4DFA-25	4DFA-35	4DFA-50
5"	5DFA-25	5DFA-35	5DFA-50
5 1/2"	55DFA-25	55DFA-35	55DFA-50
6"	6DFA-25	6DFA-35	6DFA-50
7"	7DFA-25	7DFA-35	7DFA-50
8"	8DFA-25	8DFA-35	8DFA-50

### DuraFlex AL Coupling

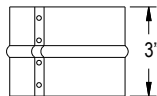

Use to connect DuraFlex AL lengths to appliance, type B gas vent, or flex lengths.

SIZE	STOCK #
3"	3DFA-FC
4"	4DFA-FC
5"	5DFA-FC
5 1/2"	55DFA-FC
6"	6DFA-FC
7"	7DFA-FC
8"	8DFA-FC

### DuraFlex AL Tee w/ Cap

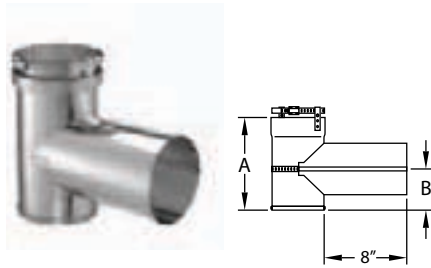

Use to attach to flex pipe with a fast connect band. Removable branch connects to the tee body with an internal fast connect band.

SIZE	STOCK #	A	B
3"	3DFA-T	8"	3"
4"	4DFA-T	9"	4"
5"	5DFA-T	9"	4"
5 1/2"	5SDFA-T	10"	5"
6"	6DFA-T	10"	5"
7"	7DFA-T	11"	5"
8"	8DFA-T	12 1/2"	6"

### DuraFlex AL Top Plate

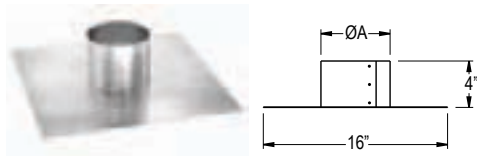

Use to seal the top of the masonry chimney.

SIZE	STOCK #	A
3"	3DFA-TP	4"
4"	4DFA-TP	5"
5"	5DFA-TP	6"
5 1/2"	5SDFA-TP	6 1/2"
6"	6DFA-TP	7"
7"	7DFA-TP	8"
8"	8DFA-TP	9"

### DuraFlex AL Cap



Use to terminate a relining system at the top of the masonry chimney. Supports flex with a fast connect band. Designed to fasten to flex length with fast connect band. No screws required.

SIZE	STOCK #	A	B
3"	3DFA-VC	8"	5"
4"	4DFA-VC	8"	5"
5"	5DFA-VC	11"	7 1/2"
5 1/2"	5SDFA-VC	11"	7 1/2"
6"	6DFA-VC	15"	7 1/4"
7"	7DFA-VC	15"	7 1/4"
8"	8DFA-VC	15"	9 5/8"

### Female Flex Adapter

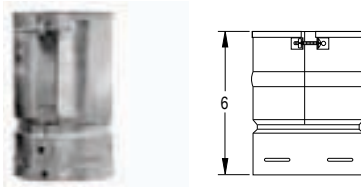

Use to connect DuraVent Type B Gas Vent products to DuraFlex AL.

SIZE	STOCK #
3"	3DFA-FA
4"	4DFA-FA
5"	5DFA-FA
6"	6DFA-FA
7"	7DFA-FA
8"	8DFA-FA

### Male Adapter

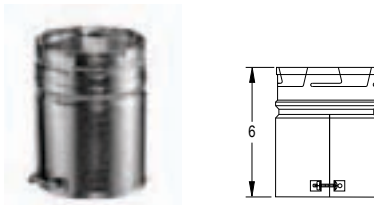

Use to connect DuraFlex AL to DuraVent Type B Gas Vent products.

SIZE	ORDER #	STOCK #
3"	3GVAM	0490
4"	4GVAM	0491
5"	5GVAM	0492
6"	6GVAM	0493
7"	7GVAM	0487
8"	8GVAM	0494

### DuraFlex Mortar Sleeve

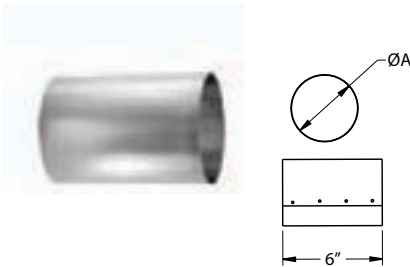

Use to protect DuraFlex when passing length through a masonry wall.

SIZE	STOCK #	A
3"	3DFA-MS	4"
4"	4DFA-MS	5"
5"	5DFA-MS	6"
5 1/2"	5SDFA-MS	6 1/2"
6"	6DFA-MS	7"
7"	7DFA-MS	8"
8"	8DFA-MS	9"

### DuraFlex Flex Puller

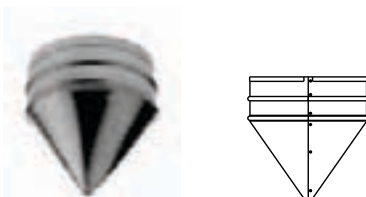

Use with a rope to guide DuraFlex lengths down masonry chimney.

SIZE	STOCK #	SIZE	STOCK #
3"	3DFA-FP	6"	6DFA-FP
4"	4DFA-FP	7"	7DFA-FP
5"	5DFA-FP	8"	8DFA-FP
5 1/2"	5SDFA-FP		

# Insulation

## Insulation Sleeve



Use to insulate DuraFlex AL to reduce condensation on gas systems. Sleeve is 10' long.

SIZE	STOCK #
3"-4"	0820
5"-6"	0822