

Ma

KEY STAGE

2

LEVELS

3-5

Mathematics tests

Test A

Calculator **not** allowed

First name						
Middle name						
Last name						
Date of birth	Day		Month		Year	
School name						
DfE number						

For marker's use only

Page	Marks
5	
7	
9	
11	
13	
15	
17	
19	
21	
23	
Total	

2013

These three children appear in some of the questions in this test.



Alfie



Chen



Megan

Instructions

You **may not** use a calculator to answer any questions in this test.

Work as quickly and as carefully as you can.

You have **45 minutes** for this test.

If you cannot do one of the questions, **go on to the next one**.

You can come back to it later, if you have time.

If you finish before the end, **go back and check your work**.

Follow the instructions for each question carefully.



This shows where you need to put the answer.

If you need to do working out, you can use any space on a page.

Some questions have an answer box like this:

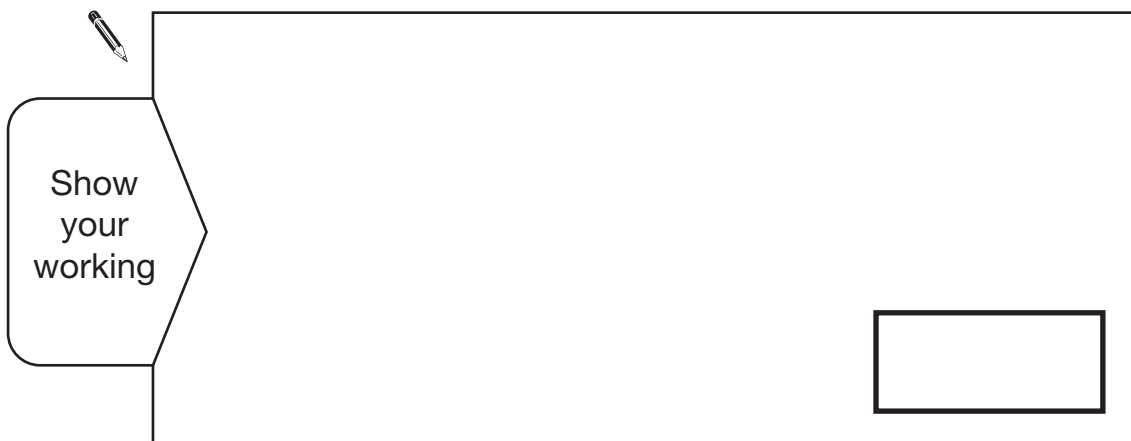

For these questions you may get a mark for showing your working.

1

The numbers in the two triangles add up to the number in the square.

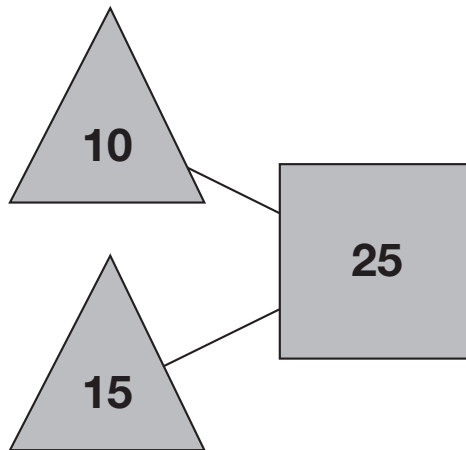

Using the **same** rule, write in the missing numbers.

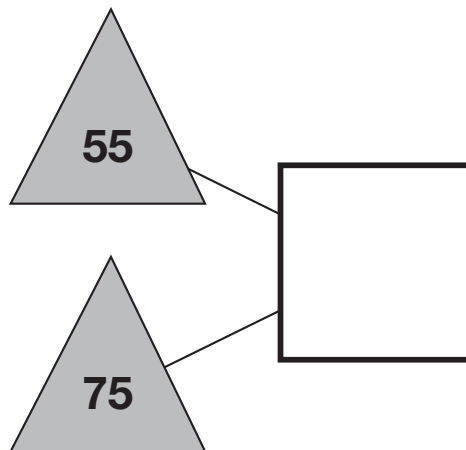

1a

1 mark

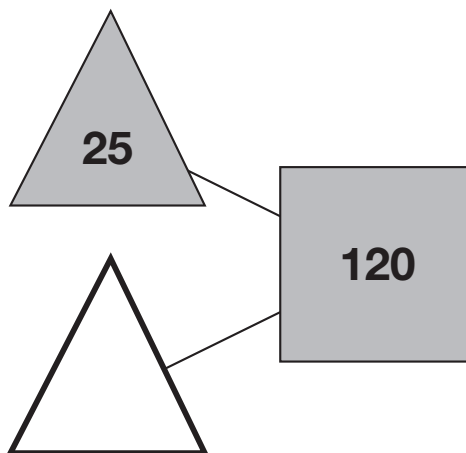

1b

1 mark

2

Draw the reflection of **all** the shaded shapes in the mirror line.

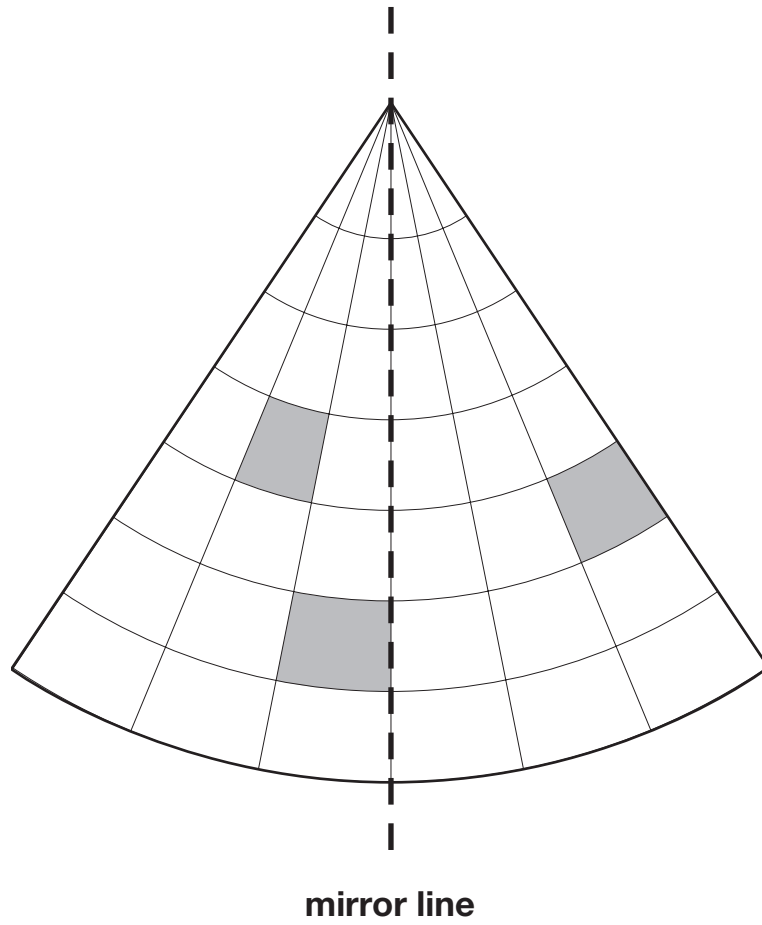

2

1 mark

Total out of 3 _____

3

Circle the number that is closest to 300



338

3030

288

313

130

3

1 mark

4

The number **20** goes in **two** of the squares of this multiplication grid.

Tick (✓) the two squares where 20 goes.



×	1	2	3	4	5
1					
2					
3					
4					
5					

4

1 mark

5

Here are three nets of a cube.

On each net draw **one more dot** so that each cube will have dots on **opposite** faces.

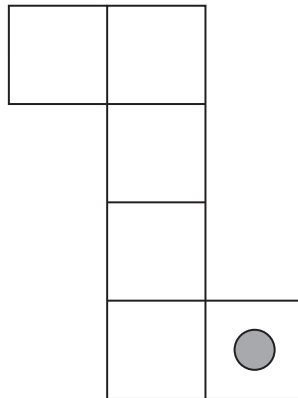
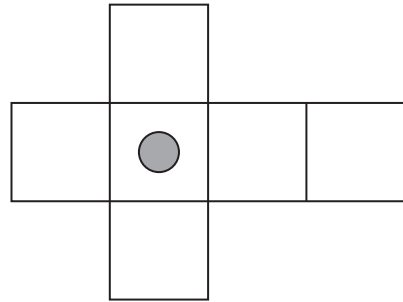
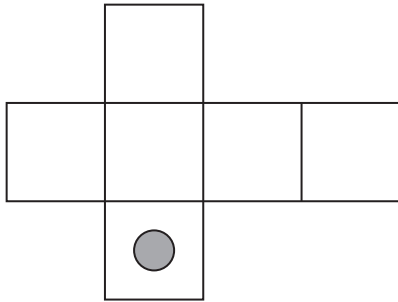

5i

5ii

2 marks

Total out of 4 _____

6

This diagram shows how nine people travel to work and how far away they live.

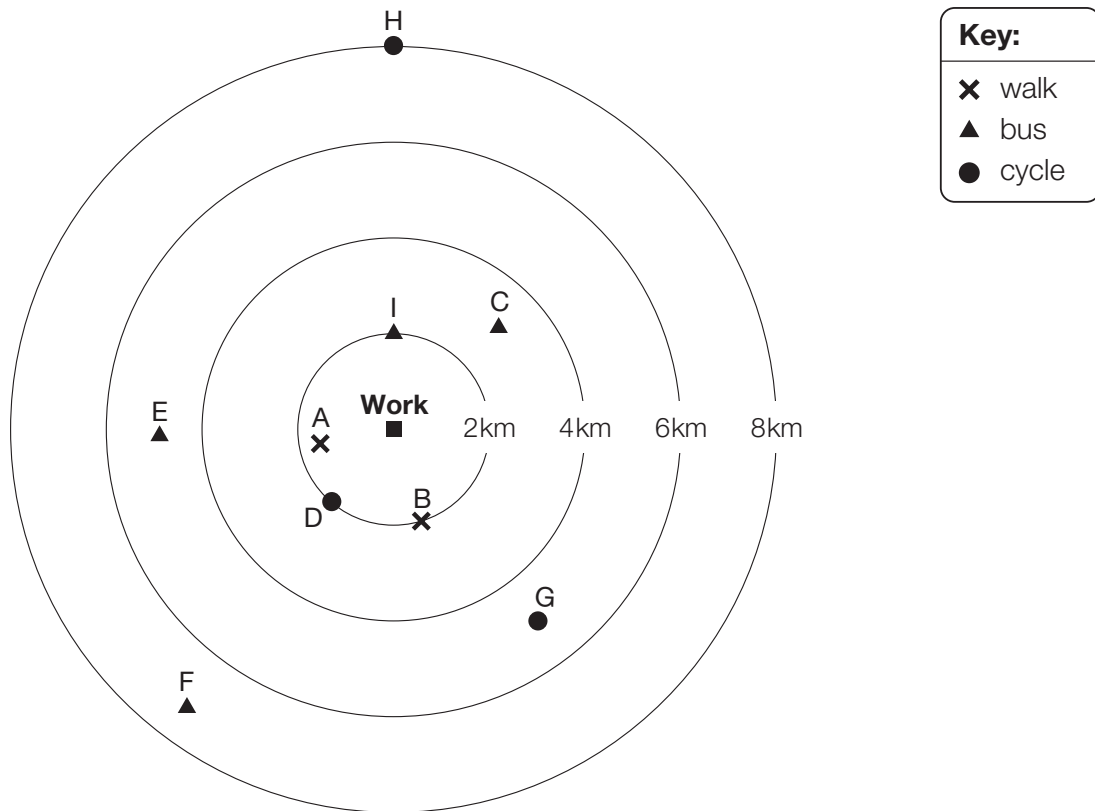

How many people live **more** than 4km from work?



6a
1 mark

How far from work does person **G** live?



6b
1 mark

Write the letter of the person who lives 2km from work and cycles.



6c
1 mark

7

Megan and Chen are washing cars.

Megan gets £39 and Chen gets £55

They share what they get **equally** between them.

How much does each of them get?



Show
your
working

£

7i

7ii

2 marks

Total out of 5 _____

8

The table shows the cost of a new football kit.

Item	Cost
Shirt	£8.75
Shorts (1 pair)	£5.95
Socks (1 pair)	£4.15

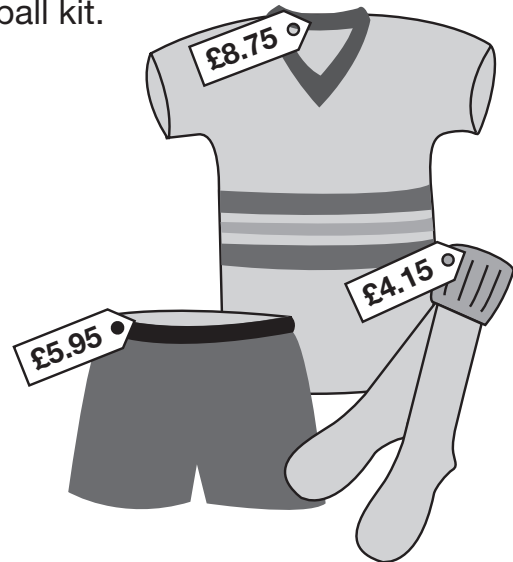

Altogether, how much does the complete football kit cost?



£

8

1 mark

9

Here are some sentences about an amount of money.

Mark each sentence with a tick (✓) if it is correct.
 Put a cross (✗) if it is not correct.

One has been done for you.

£1.03 can be made with exactly 1 coin.



£1.03 can be made with exactly 2 coins.

£1.03 can be made with exactly 3 coins.

£1.03 can be made with exactly 4 coins.

9

1 mark

10

Here are four designs made from two sizes of circles.

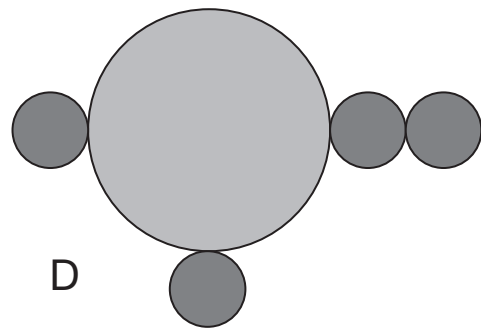
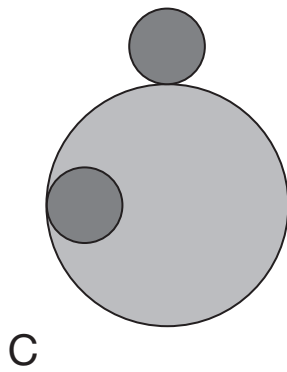
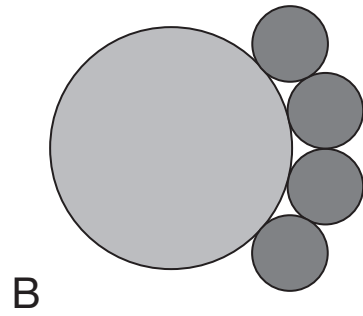
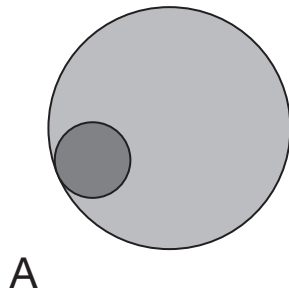

Write the letters of **all** the designs that have line symmetry.



10i

10ii

2 marks

Total out of 4 _____

11

Write in the missing numbers.



Number	Rounded to the nearest whole number
5.05	
5.55	
4.45	
4.54	

11i

11ii

2 marks

12

Complete these calculations.



$$15 \times 100 = \boxed{}$$

$$\boxed{} \times 10 = 1500$$

$$\boxed{} \div 100 = 150$$

$$150 \div 10 = \boxed{}$$

12i

12ii

2 marks

13

Alfie places three cubes on a coordinate grid.
The base of his shape is a rectangle.

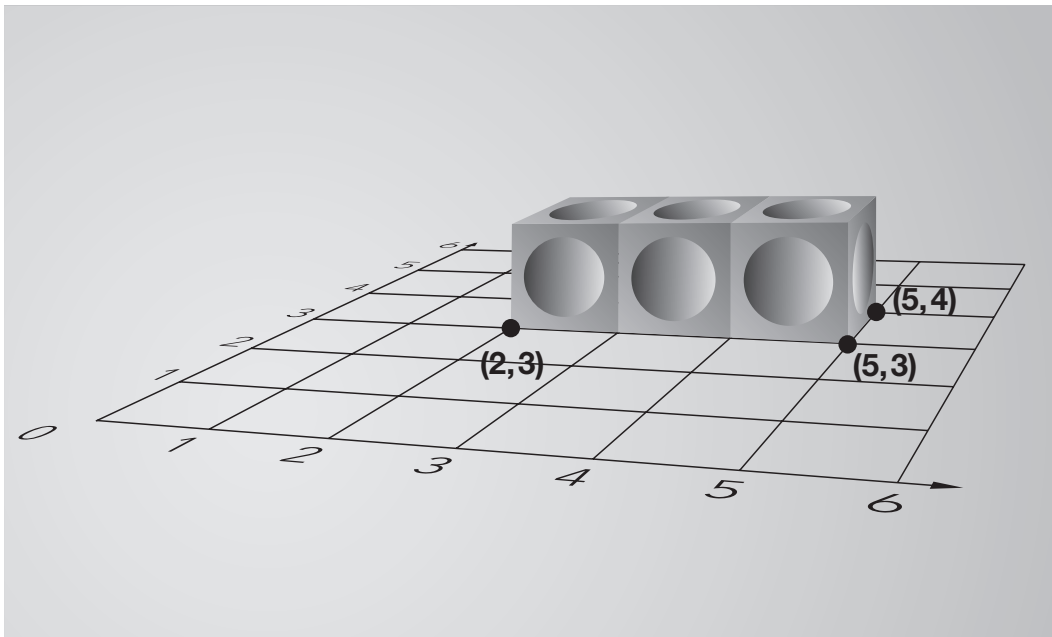

Complete this sentence:

The four **vertices** of the rectangle are

$(2, 3)$, $(5, 3)$, $(5, 4)$

and



1 mark

13

Total out of 5 _____

14

Tick (✓) each shape that is exactly $\frac{1}{4}$ shaded.

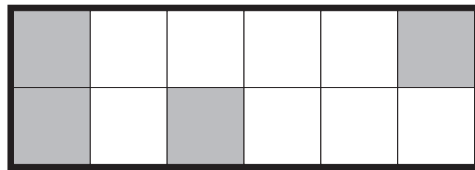
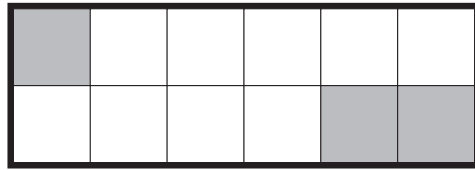

14

1 mark

15

Four children are in a race.

Chen is 2 metres ahead of Alfie.

Nina is 5 metres behind Megan.

Alfie is 3 metres behind Megan.

Write the names of the runners in order, starting with the child who is furthest ahead.



furthest
ahead

15

1 mark

16

Alfie buys **two** books, each at the same price.

He pays with a £10 note and gets £2.30 change.

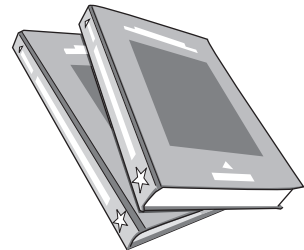

What is the cost of **one** book?



Show
your
working

£

16i

16ii

2 marks

Total out of 4 _____

17

This graph shows the distance Alfie and Chen walked in an afternoon. They started at 1:45pm and had two breaks.

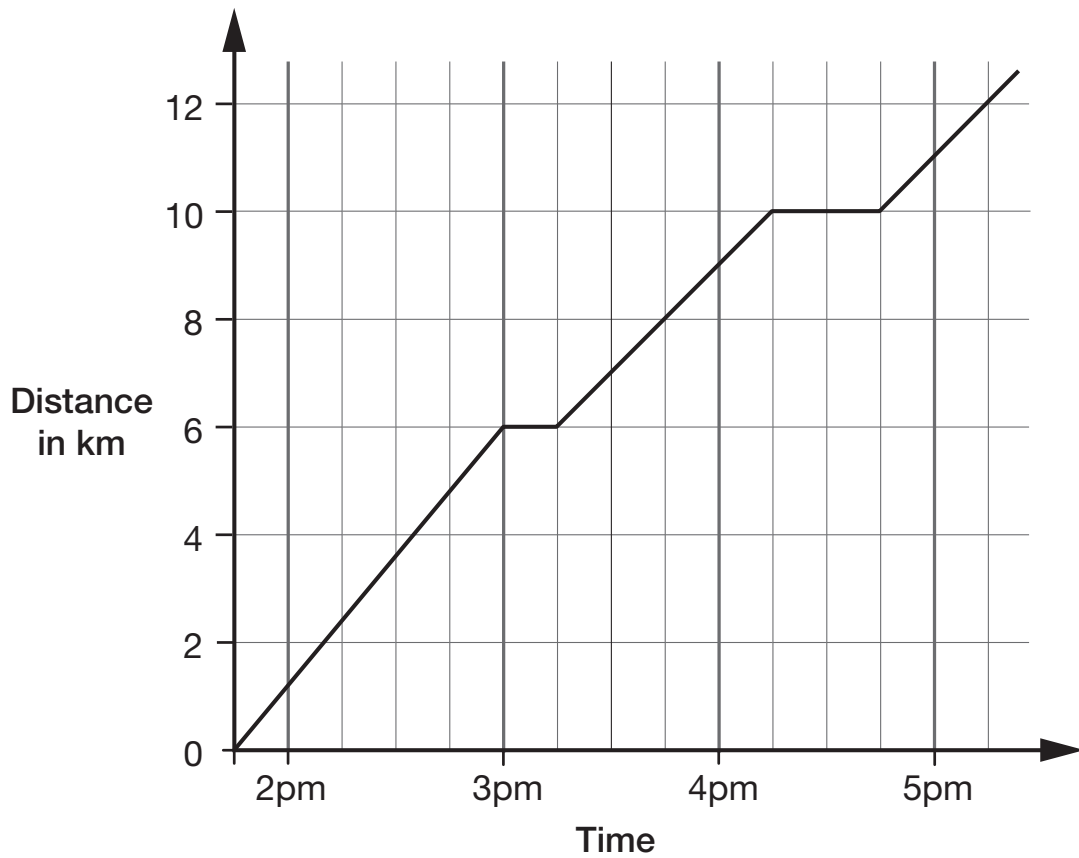

How many kilometres did they walk **between** the first and second breaks?



17a

1 mark

At what time did Alfie and Chen start their second break?



17b

1 mark

18

Here is a spinner.

Write a whole number in each section of the spinner so that it is **certain** you will get a number less than 4 and it is **impossible** you will get an even number.

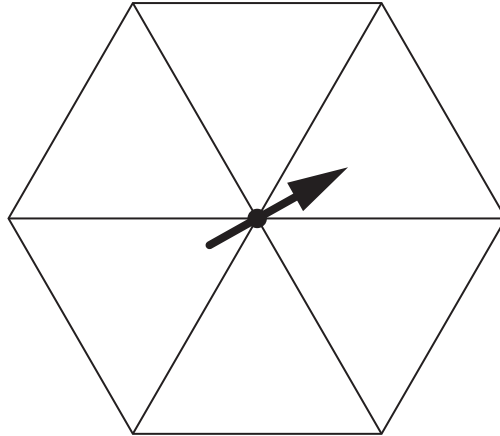

18

1 mark

19

Calculate $816 \div 24$



Show
your
working

19i

19ii

2 marks

Total out of 5 _____

20

Chen and Megan each have a parcel.

Chen's parcel weighs $1\frac{1}{2}$ kg.

Megan's parcel weighs 1.2kg.

How many more **grams** does Chen's parcel weigh than Megan's parcel?



Show
your
working

grams

20i

20ii

2 marks

21

20% of Megan's number is 64

What is 50% of Megan's number?



Show
your
working

21i

21ii

2 marks

22

Write these in order of size, starting with the smallest.

$\frac{2}{3}$

0.5

$\frac{3}{5}$

0.65



smallest

22

1 mark

Total out of 5 _____

23

Alfie has some rectangles.

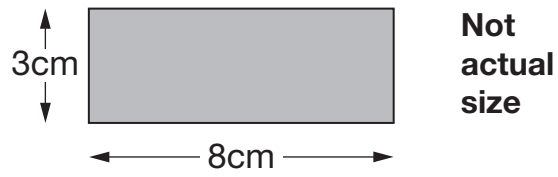

He makes this shape using three of the rectangles.

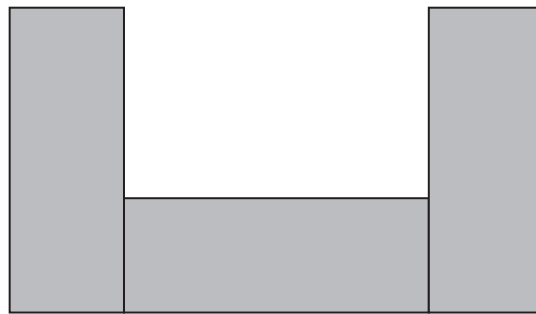

What is the **perimeter** of Alfie's shape?

Show your working

23i

23ii

2 marks



A cake costs 15p more than a biscuit.

Megan bought a cake and two biscuits for 90p.

How much do a cake and a biscuit each cost?

 Show your working

Cost of a cake p Cost of a biscuit p

24i

24ii

2 marks

Total out of 4 _____

Chen and Megan each have a set of numbered counters.

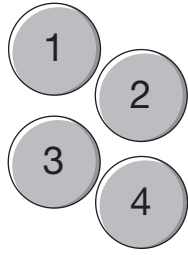

Chen

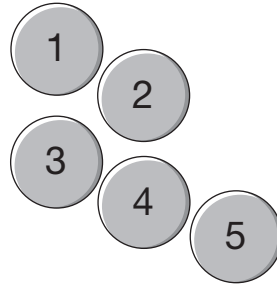

Megan

They each take one of their own counters without looking.

Chen says,

'I am more likely than Megan to get a 4'

Is Chen correct?
Circle **Yes** or **No**.



Yes / No

Explain how you know.



[BLANK PAGE]

Please do not write on this page.

Total out of 1 _____



Standards
& Testing
Agency

2013 Key Stage 2 levels 3–5 mathematics: Test A – Calculator not allowed

Print version product code: STA/13/6022/p ISBN: 978-1-4459-5683-1

Electronic PDF version product code: STA/13/6022/e ISBN: 978-1-4459-5684-8

© Queen's Printer and Controller of HMSO 2013

Material contained in these booklets may be reproduced for educational and training purposes within a school setting, provided you acknowledge the copyright ownership of the material and you give the title of the source document. Reproduction or re-use of the material is not permitted for any commercial purpose.

For more copies

Additional printed copies of this booklet are not available. It can be downloaded from STA's orderline at <http://orderline.education.gov.uk>.