

BEVERAGE DISPENSING EQUIPMENT

Let It Flow

Draft Doctor's
Sales & Service
604 992 6355
www.draft-doctor.com
info@draft-doctor.com

BEER

COLD COFFEE

FOUNTAIN

WATER

WINE

2017



**Draft Doctor's
Sales & Service
www.draft-doctor.com
info@draft-doctor.com
604-992-6355**



^
INNOVATIVE TOWERS



<
QUALITY CRAFTSMANSHIP

CREATIVE BRANDING



<
CREATIVE PROMOTION



CHILL-MAX™

INNOVATIVE COOLING TECHNOLOGY

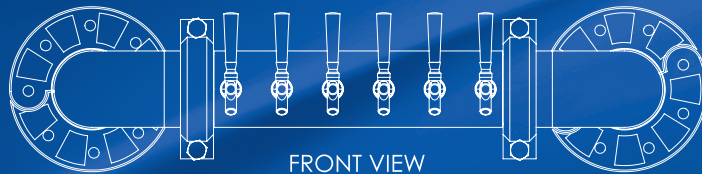

FRONT VIEW

**QUALITY DESIGN
&
FABRICATION**

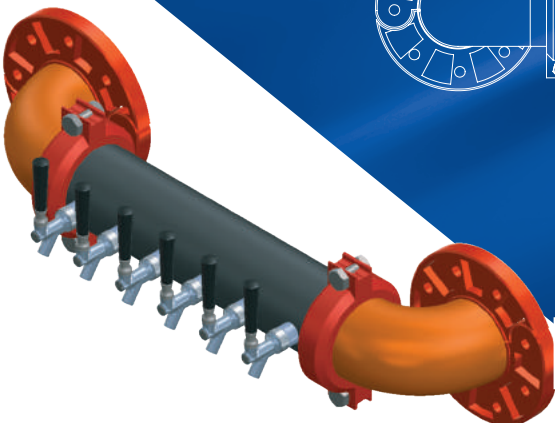



Draught Beer

Pages 6–91



Towers
Page 6



Drip Trays
Page 25



Faucets
Page 32



Tap Handles
Page 37



Power Packs
Page 46



Trunkline
Page 50



Fittings
Page 54



Walk-In Cooler
Page 60



Special Event
Page 78



Cleaning
Page 83



Refrigeration
Page 86



Material Handling
Page 90



Fountain

Pages 92–103



BIB Pumps
Page 92



Carbonators
Page 93



BIB Racks
Page 94



Regulators
Page 95



Bar Guns
Page 98



Dispensers
Page 100



Tubing
Page 101



Tanks
Page 103



Water

Pages 104-111



Towers

Page 104



Tap Handles

Page 107



Carbonators

Page 108



Refrigeration

Page 109



Filters

Page 110



Wine

Pages 112-116



Towers

Page 112



Tap Handles

Page 41



Faucets

Page 114



BIB Pumps

Page 115



Trunkline

Page 116



Cold Coffee

Pages 117-118



Towers

Page 117



Refrigeration

Page 118



Tap Handles

Page 117



Faucets

Page 32



Drip Trays

Page 25



Tanks

Page 118

DRAUGHT BEER TOWERS: EUROPEAN

SEXY

Part Number	Taps	Finish	Cooling	Drip Tray
BB102081A-CK	1	Gold	Glycol	10"
BB102082A-CK	2	Gold	Glycol	10"
BB102083A-CK	3	Gold	Glycol	12"
BB102084A-CK	4	Gold	Glycol	15"
BB102091A-CK	1	Chrome	Glycol	10"
BB102092A-CK	2	Chrome	Glycol	10"
BB102093A-CK	3	Chrome	Glycol	12"
BB102094A-CK	4	Chrome	Glycol	15"

Air cooled versions of this tower style are also available.

LIT SEXY

Part Number	Taps	Finish	Cooling	Drip Tray
BB102085A-CK	1	Gold	Glycol	10"
BB102086A-CK	2	Gold	Glycol	10"
BB102087A-CK	3	Gold	Glycol	12"
BB102088A-CK	4	Gold	Glycol	15"
BB102095A-CK	1	Chrome	Glycol	10"
BB102096A-CK	2	Chrome	Glycol	10"
BB102097A-CK	3	Chrome	Glycol	12"
BB102098A-CK	4	Chrome	Glycol	15"

Air cooled versions of this tower style are also available.

SEXY ICE

Part Number	Taps	Finish	Cooling	Drip Tray
BB102095A-ICE	1	Chrome	Glycol	40cm
BB102096A-ICE	2	Chrome	Glycol	40cm
BB102097A-ICE	3	Chrome	Glycol	40cm
BB102098A-ICE	4	Chrome	Glycol	40cm

LIT SEXY ICE

Part Number	Taps	Finish	Cooling	Drip Tray
BB102061A-ICE	1	Chrome	Glycol	40cm
BB102062A-ICE	2	Chrome	Glycol	40cm
BB102063A-ICE	3	Chrome	Glycol	40cm
BB102064A-ICE	4	Chrome	Glycol	40cm

SUPER SEXY

Part Number	Taps	Finish	Cooling	Drip Tray
BB102077G-CK	1	Gold	Glycol	10"
BB102078G-CK	2	Gold	Glycol	10"
BB102077C-CK	1	Chrome	Glycol	10"
BB102078C-CK	2	Chrome	Glycol	10"

★ MEDALLIONS & TAP HANDLES NOT INCLUDED

★ TAPS SOLD SEPARATELY

SEXY



BB102092A-CK



BB102085A-CK



BB102060C-1A



BB102077C-CK



BB102098A-CK

MADE IN EUROPE



ASSEMBLED IN CANADA

**CBS LIGHTS IT UP!
WE OFFER THE WIDEST SELECTION
OF ILLUMINATED DRAUGHT BEER
TOWERS IN NORTH AMERICA.**

Choose the tower that best represents your brand and we will produce the graphics to personalize it!

CBS has an in-house graphics department that is dedicated to delivering the merchandising solution that will drive sales revenue. Our minimum order for a custom tower is one.

Showcase your brands with a variety of medallions!



ALL TOWERS
ON THIS PAGE



DRAUGHT BEER TOWERS: EUROPEAN

SHIELD



BB102113AC-CK

BB102116AC-CK

LIT SHIELD

Part Number	Taps	Finish	Cooling	Drip Tray
BB102113AC-CK	1	Chrome	Glycol	10"
BB102114AC-CK	2	Chrome	Glycol	10"
BB102115AC-CK	3	Chrome	Glycol	12"

Air cooled versions of this tower style are also available.

LIT SHIELD WITH MEDALLIONS

Part Number	Taps	Finish	Cooling	Drip Tray
BB102116AC-CK	2	Chrome	Glycol	10"
BB102117AC-CK	3	Chrome	Glycol	12"

Air cooled versions of this tower style are also available.



BB102125A-CK

BB102132A-CK

LUCKY

Part Number	Taps	Finish	Cooling	Drip Tray
BB102121A-CK	1	Gold	Glycol	10"
BB102126A-CK	2	Gold	Glycol	10"
BB102135A-CK	3	Gold	Glycol	12"
BB102122A-CK	1	Chrome	Glycol	10"
BB102125A-CK	2	Chrome	Glycol	10"
BB102132A-CK	3	Chrome	Glycol	12"

Air cooled versions of this tower style are also available.

LIT LUCKY

Part Number	Taps	Finish	Cooling	Drip Tray
BB102124A-CK	1	Gold	Glycol	10"
BB102128A-CK	2	Gold	Glycol	10"
BB102136A-CK	3	Gold	Glycol	12"
BB102123A-CK	1	Chrome	Glycol	10"
BB102130A-CK	2	Chrome	Glycol	10"
BB102133A-CK	3	Chrome	Glycol	12"

Air cooled versions of this tower style are also available.

LUCKY ICE

Part Number	Taps	Finish	Cooling	Drip Tray
BB102123A-ICE	1	Chrome	Glycol	40cm
BB102127A-ICE	2	Chrome	Glycol	40cm

★ MEDALLIONS & TAP HANDLES NOT INCLUDED
 ★ TAPS SOLD SEPARATELY

ALL TOWERS
ON THIS PAGE



MADE IN EUROPE



ASSEMBLED IN CANADA



BB102130A-CK

LUCKY

DRAUGHT BEER TOWERS: EUROPEAN

PANTHER

Part Number	Taps	Finish	Cooling	Drip Tray
BB102106A-CK	3	Gold	Glycol	12"
BB102111A-CK	4	Gold	Glycol	15"
BB102105A-CK	3	Chrome	Glycol	12"
BB102110A-CK	4	Chrome	Glycol	15"

Air cooled versions of this tower style are also available.

LIT PANTHER

Part Number	Taps	Finish	Cooling	Drip Tray
BB102109A-CK	3	Gold	Glycol	12"
BB102107A-CK	3	Chrome	Glycol	12"

Air cooled versions of this tower style are also available.

PANTHER ICE

Part Number	Taps	Finish	Cooling	Drip Tray
BB102105A-ICE	3	Chrome	Glycol	40cm
BB102110A-ICE	4	Chrome	Glycol	40cm

LIT PANTHER ICE

Part Number	Taps	Finish	Cooling	Drip Tray
BB102108A-ICE	3	Chrome	Glycol	40cm

★ TAP HANDLES NOT INCLUDED

★ TAPS SOLD SEPARATELY

ALL TOWERS
ON THIS PAGE



FLAT GLYCOL DECK

Part Number	Description
BB989950	Flat Glycol Deck



BB102107A-CK

BB102110A-CK

PANTHER



BB102105A-ICE

MADE IN EUROPE



ASSEMBLED IN CANADA

ICE TOWER

Keep your beer nice and cold!
This innovative design will attract attention
and drive your revenue.

Ice Towers are covered in a layer of ice
on the outside, drawing attention to your
brand and delivering on the promise of
pouring a cold one!



BB989950



DRAUGHT BEER TOWERS: EUROPEAN

LUCKY AKT FOR DIRECT DRAW

Part Number	Taps	Finish	Cooling
BB102122G-1A	1	Gold	Air
BB102122G-2A	2	Gold	Air
BB102122C-1A	1	Chrome	Air
BB102122C-2A	2	Chrome	Air

SEXY AKT FOR DIRECT DRAW

Part Number	Taps	Finish	Cooling
BB102060G-1A	1	Gold	Air
BB102060G-2A	2	Gold	Air
BB102060C-1A	1	Chrome	Air
BB102060C-2A	2	Chrome	Air

AIR DRAWN KIT - AKT

Part Number	Description
BB800100	Complete Air Drawn Kit

24" DIRECT DRAW DISPENSERS

Part Number	Description
REX00024	KC24 1 DR - No Tower
REX00024-SD	KC24 1 SS DR - No Tower

★ TAP HANDLES NOT INCLUDED

★ TAPS SOLD SEPARATELY



MADE IN EUROPE



ASSEMBLED IN CANADA

BB102060C-2A

BB102122C-1A

BB800100

Shown with optional tower



REX00024-SD



REX00024

ALL TOWERS
ON THIS PAGE



DRAUGHT BEER TOWERS: EUROPEAN



ZEUS BLACK CERAMIC WITH CHILL-MAX™

Part Number	Taps	Finish	Cooling	Drip Tray	Cut-Out
BB101370CB-CK	3	Chrome/Black	Glycol	500mm	210mm
BB101370GB-CK	3	Gold/Black	Glycol	500mm	210mm
BB101371CB-CK	4	Chrome/Black	Glycol	500mm	210mm
BB101371GB-CK	4	Gold/Black	Glycol	500mm	210mm
BB101372CB-CK	5	Chrome/Black	Glycol	500mm	210mm
BB101372GB-CK	5	Gold/Black	Glycol	500mm	210mm

Air cooled versions of this tower style are also available.



ZEUS

ZEUS GREEN CERAMIC WITH CHILL-MAX™

Part Number	Taps	Finish	Cooling	Drip Tray	Cut-Out
BB101370CG-CK	3	Chrome/Green	Glycol	500mm	210mm
BB101370GG-CK	3	Gold/Green	Glycol	500mm	210mm
BB101371CG-CK	4	Chrome/Green	Glycol	500mm	210mm
BB101371GG-CK	4	Gold/Green	Glycol	500mm	210mm
BB101372CG-CK	5	Chrome/Green	Glycol	500mm	210mm
BB101372GG-CK	5	Gold/Green	Glycol	500mm	210mm

Air cooled versions of this tower style are also available.

BB101371CB-CK
Towers shown with optional Euro style taps



MADE IN EUROPE



ASSEMBLED IN CANADA

ZEUS BLUE CERAMIC WITH CHILL-MAX™

Part Number	Taps	Finish	Cooling	Drip Tray	Cut-Out
BB101370CN-CK	3	Chrome/Blue	Glycol	500mm	210mm
BB101370GN-CK	3	Gold/Blue	Glycol	500mm	210mm
BB101371CN-CK	4	Chrome/Blue	Glycol	500mm	210mm
BB101371GN-CK	4	Gold/Blue	Glycol	500mm	210mm
BB101372CN-CK	5	Chrome/Blue	Glycol	500mm	210mm
BB101372GN-CK	5	Gold/Blue	Glycol	500mm	210mm

Air cooled versions of this tower style are also available.

ALL TOWERS ON THIS PAGE



BB101371GG-CK

ZEUS WHITE CERAMIC WITH CHILL-MAX™

Part Number	Taps	Finish	Cooling	Drip Tray	Cut-Out
BB101370CW-CK	3	Chrome/White	Glycol	500mm	210mm
BB101370GW-CK	3	Gold/White	Glycol	500mm	210mm
BB101371CW-CK	4	Chrome/White	Glycol	500mm	210mm
BB101371GW-CK	4	Gold/White	Glycol	500mm	210mm
BB101372CW-CK	5	Chrome/White	Glycol	500mm	210mm
BB101372GW-CK	5	Gold/White	Glycol	500mm	210mm

Air cooled versions of this tower style are also available.



BB101371GB-CK

★ TAP HANDLES NOT INCLUDED

★ TAPS SOLD SEPARATELY

CUSTOMIZE YOUR TOWER

- Faucets
- Finish
- Medallions
- Tap Handles
- Printed Logo

DRAUGHT BEER TOWERS: EUROPEAN



BB102140A-CK



BB102150A-CK



MONGOOSE

Part Number	Taps	Finish	Cooling	Drip Tray
BB102140A-CK	1	Chrome	Glycol	10"
BB102141A-CK	1	Gold	Glycol	10"
BB102142A-CK	1	Dark Nickel	Glycol	10"
BB102150A-CK	2	Chrome	Glycol	10"
BB102151A-CK	2	Gold	Glycol	10"
BB102152A-CK	2	Dark Nickel	Glycol	10"
BB102160A-CK	3	Chrome	Glycol	12"
BB102161A-CK	3	Gold	Glycol	12"
BB102162A-CK	3	Dark Nickel	Glycol	12"
BB102170A-CK	4	Chrome	Glycol	15"
BB102171A-CK	4	Gold	Glycol	15"
BB102172A-CK	4	Dark Nickel	Glycol	15"

Air cooled versions of this tower style are also available.

MONGOOSE



BB102160A-CK



BB102170A-CK



BB102172A-CK



BB102175A-CK

ALL TOWERS ON THIS PAGE



LIT MONGOOSE

Part Number	Taps	Finish	Cooling	Drip Tray
BB102175A-CK	4	Chrome	Glycol	15"
BB102176A-CK	4	Gold	Glycol	15"
BB102177A-CK	4	Dark Nickel	Glycol	15"

Air cooled versions of this tower style are also available.

★ MEDALLIONS & TAP HANDLES NOT INCLUDED

★ TAPS SOLD SEPARATELY

DRAUGHT BEER TOWERS: EUROPEAN

IDEA

Part Number	Taps	Finish	Cooling	Drip Tray
BB102370A-CK	1	Chrome	Glycol	10"
BB102375A-CK	2	Chrome	Glycol	10"

Air cooled versions of this tower style are also available.

LIT IDEA

Part Number	Taps	Finish	Cooling	Drip Tray
BB102373C-CK	1	Chrome	Glycol	10"

Air cooled versions of this tower style are also available.



BB102373C-CK



BB102375A-CK

MADE IN EUROPE



ASSEMBLED IN CANADA

IDEA

MONACO

Part Number	Taps	Finish	Cooling	Drip Tray
BB102300A-CK	2	Chrome	Glycol	20"
BB102310A-CK	3	Chrome	Glycol	20"
BB102315A-CK	4	Chrome	Glycol	24"
BB102320A-CK	5	Chrome	Glycol	24"
BB102325A-CK	6	Chrome	Glycol	36"
BB102330A-CK	7	Chrome	Glycol	36"

Air cooled versions of this tower style are also available.

★ MEDALLIONS & TAP HANDLES NOT INCLUDED

★ TAPS SOLD SEPARATELY



BB102310A-CK

MONACO



BB102320A-CK



BB102330A-CK

Towers shown with optional Euro style taps

ALL TOWERS
ON THIS PAGE



BRIGITTE



BB102050-3CK



BB102050-5CK

MADE IN EUROPE



ASSEMBLED IN CANADA



BB102346A-CK

TANGO

APOLLO



BB102360A-CK



BB102368A-CK

V3

ALL TOWERS
ON THIS PAGE



DRAUGHT BEER TOWERS: EUROPEAN

■ DRAUGHT BEER

LIT BRIGITTE

Part Number	Taps	Finish	Cooling	Drip Tray
BB102050-3CK	3	Chrome	Glycol	20"
BB102050-5CK	5	Chrome	Glycol	24"
BB102050-7CK	7	Chrome	Glycol	36"

Air cooled versions of this tower style are also available.



BB102050-7CK

LIT TANGO

Part Number	Taps	Finish	Cooling	Drip Tray
BB102346A-CK	1	Chrome	Glycol	10"

Air cooled versions of this tower style are also available.

APOLLO

Part Number	Taps	Finish	Cooling	Drip Tray
BB102360A-CK	1	Chrome	Glycol	10"

Air cooled versions of this tower style are also available.

LIT APOLLO

Part Number	Taps	Finish	Cooling	Drip Tray
BB102364A-CK	1	Chrome	Glycol	10"

Air cooled versions of this tower style are also available.

APOLLO V3

Part Number	Taps	Finish	Cooling	Drip Tray
BB102366A-CK	1	Brushed SS	Glycol	10"

Air cooled versions of this tower style are also available.

LIT APOLLO V3

Part Number	Taps	Finish	Cooling	Drip Tray
BB102368A-CK	1	Brushed SS	Glycol	10"

Air cooled versions of this tower style are also available.

★ MEDALLIONS & TAP HANDLES NOT INCLUDED

★ TAPS SOLD SEPARATELY

DRAUGHT BEER TOWERS: AMERICAN



METRO "T" WITH CHILL-MAX™

Part Number	Taps	Finish	Cooling	Drip Tray
BB102700-4SSCK	4	Polished SS	Glycol	20"
BB102700-6SSCK	6	Polished SS	Glycol	24"
BB102701-08SSCK	8	Polished SS	Glycol	30"
BB102701-10SSCK	10	Polished SS	Glycol	30"
BB102701-12SSCK	12	Polished SS	Glycol	36"

Air cooled versions of this tower style are also available.

METRO "T"



BB102701-8SSCK

LIT METRO "T" WITH CHILL-MAX™

Part Number	Taps	Finish	Cooling	Drip Tray
BB102703-4SSCK	4	Polished SS	Glycol	24"
BB102703-6SSCK	6	Polished SS	Glycol	24"
BB102703-8SSCK	8	Polished SS	Glycol	30"

Air cooled versions of this tower style are also available.



BB102703-4SSCK

★ MEDALLIONS & TAP HANDLES NOT INCLUDED

★ TAPS SOLD SEPARATELY



METRO TOWER DRIP TRAYS - WITH DRAIN

Part Number	Taps	L	W	H	Glass Rinser	Cut-Out
BB701163	4-6	24"	8"	7/8"	X	Center
BB702163	4-6	24"	8"	7/8"	✓	Center
BB701628	8	28"	8"	7/8"	X	Corners
BB702628	8	28"	8"	7/8"	✓	Corners
BB701180	8-10	34"	8"	7/8"	X	Center
BB701634	10	34"	8"	7/8"	X	Corners
BB702634	10	34"	8"	7/8"	✓	Corners
BB702180	8-10	34"	8"	7/8"	✓	Center
BB701640	12	40"	8"	7/8"	X	Corners
BB702640	12	40"	8"	7/8"	✓	Corners
BB701646	14	46"	8"	7/8"	X	Corners
BB702646	14	46"	8"	7/8"	✓	Corners
BB701652	16	52"	8"	7/8"	X	Corners
BB702652	16	52"	8"	7/8"	✓	Corners



BB701640



BB702163



BB701163





BB102710-12SSCK

METRO "H"

DRAUGHT BEER TOWERS: AMERICAN

■ DRAUGHT BEER

METRO "H" WITH CHILL-MAX™

Part Number	Taps	Finish	Cooling	Drip Tray
BB102710-08SSCK	8	Polished SS	Glycol	28"
BB102710-10SSCK	10	Polished SS	Glycol	34"
BB102710-12SSCK	12	Polished SS	Glycol	40"
BB102710-14SSCK	14	Polished SS	Glycol	46"
BB102710-16SSCK	16	Polished SS	Glycol	52"

Air cooled versions of this tower style are also available.



BB102715-16SSCK

METRO "M"

METRO "M" WITH CHILL-MAX™

Part Number	Taps	Finish	Cooling	Drip Tray
BB102715-16SSCK	16	Polished SS	Glycol	2 x 28"
BB102715-20SSCK	20	Polished SS	Glycol	2 x 34"
BB102715-24SSCK	24	Polished SS	Glycol	2 x 40"

Air cooled versions of this tower style are also available.

★ TAP HANDLES NOT INCLUDED

★ TAPS SOLD SEPARATELY



ALL TOWERS
ON THIS PAGE



METRO "HHH" WITH CHILL-MAX™

Part Number	Taps	Finish	Cooling	Drip Tray
BB102725-24SSCK	24	Polished SS	Glycol	3 x 28"
BB102725-30SSCK	30	Polished SS	Glycol	3 x 34"
BB102725-36SSCK	36	Polished SS	Glycol	3 x 40"

Air cooled versions of this tower style are also available.



BB102725-24SSCK

METRO "HHH"



ALL PRODUCTS ON THIS PAGE MADE FROM 304SS

DRAUGHT BEER TOWERS: AMERICAN



MUSHROOM WITH CHILL-MAX™

Part Number	Taps	Finish	Cooling	Drip Tray	Cut-Out
BB101384C-CK	4	Polished SS	Glycol	19"	7.5"
BB101385C-CK	5	Polished SS	Glycol	19"	7.5"
BB101386C-CK	6	Polished SS	Glycol	24"	7.5"

Air cooled versions of this tower style are also available.



BB101386C-CK

MUSHROOM

MINI MUSHROOM WITH CHILL-MAX™

Part Number	Taps	Finish	Cooling	Drip Tray	Cut-Out
BB101373C-CK	3	Polished SS	Glycol	14"	6"
BB101374C-CK	4	Polished SS	Glycol	18"	6"
BB101375C-CK	5	Polished SS	Glycol	18"	6"

Air cooled versions of this tower style are also available.



BB101373C-CK



MINI MUSHROOM

LANTERN WITH CHILL-MAX™

Part Number	Taps	Finish	Cooling	Drip Tray
BB103373C-CK	3	Polished SS	Glycol	12" x 7"
BB103374C-CK	4	Polished SS	Glycol	16" x 7"
BB103375C-CK	5	Polished SS	Glycol	16" x 7"

Air cooled versions of this tower style are also available.



BB103373C-CK

★ TAP HANDLES NOT INCLUDED

★ TAPS SOLD SEPARATELY

LANTERN

ALL TOWERS ON THIS PAGE



ALL PRODUCTS ON THIS PAGE MADE FROM 304SS



DRAUGHT BEER TOWERS: AMERICAN

DRAUGHT BEER

"T" TOWER-3"



BB102010-06CK

"T" TOWER - 3" WITH **CHILL-MAX™**

Part Number	Taps	Finish	Length	Cooling	Drip Tray
BB102010-03CK	3	Brushed SS	12"	Glycol	12"
BB102010-04CK	4	Brushed SS	12"	Glycol	12"
BB102010-05CK	5	Brushed SS	16"	Glycol	15"
BB102010-06CK	6	Brushed SS	18"	Glycol	20"

Air cooled versions of this tower style are also available.

"T" TOWER-4"



BB102020-04CK

"T" TOWER - 4" WITH **CHILL-MAX™**

Part Number	Taps	Finish	Length	Cooling	Drip Tray
BB102020-04CK	4	Brushed SS	12"	Glycol	12"
BB102020-05CK	5	Brushed SS	16"	Glycol	15"
BB102020-06CK	6	Brushed SS	20"	Glycol	20"
BB102020-08CK	8	Brushed SS	24"	Glycol	24"

Air cooled versions of this tower style are also available.



BB102020-08CK



DBL PEDESTAL-4"

DOUBLE PEDESTAL - 4" WITH **CHILL-MAX™**



BB102030-08CK

Part Number	Taps	Finish	Length	Cooling	Drip Tray
BB102030-08CK	8	Brushed SS	27"	Glycol	24"
BB102030-10CK	10	Brushed SS	31"	Glycol	30"
BB102030-12CK	12	Brushed SS	39"	Glycol	39"
BB102030-14CK	14	Brushed SS	45"	Glycol	45"
BB102030-16CK	16	Brushed SS	51"	Glycol	51"
BB102030-20CK	20	Brushed SS	60"	Glycol	2 x 30"
BB102030-24CK	24	Brushed SS	72"	Glycol	2 x 36"

Air cooled versions of this tower style are also available.

TAP HANDLES NOT INCLUDED

TAPS SOLD SEPARATELY



ALL PRODUCTS ON THIS PAGE MADE FROM 304SS

DRAUGHT BEER TOWERS: AMERICAN



4" PASS THRU WITH CHILL-MAX™

Part Number	Taps	Finish	Length	Cooling	Drip Tray
BB102479-06CK	6	Brushed SS	30"	Glycol	30"
BB102479-08CK	8	Brushed SS	33"	Glycol	30"
BB102479-10CK	10	Brushed SS	39"	Glycol	36"
BB102479-12CK	12	Brushed SS	45"	Glycol	45"
BB102479-14CK	14	Brushed SS	52"	Glycol	45"
BB102479-16CK	16	Brushed SS	57"	Glycol	51"

Air cooled versions of this tower style are also available.



BB102479-08CK



BB102479-14CK

PASS THRU

4" LIT PASS THRU WITH CHILL-MAX™

Part Number	Taps	Finish	Length	Cooling	Drip Tray
BB101382C-08CK	8	Polished SS	40"	Glycol	36"
BB101382C-10CK	10	Polished SS	48"	Glycol	45"
BB101382C-12CK	12	Polished SS	56"	Glycol	51"

Air cooled versions of this tower style are also available.



★ MEDALLIONS & TAP HANDLES NOT INCLUDED

★ TAPS SOLD SEPARATELY

ALL TOWERS ON THIS PAGE



BB101382C-10CK





DRAUGHT BEER TOWERS: AMERICAN



BB102770-10SSCK

BRIDGE



BB102765-10SS

RAIL



BB102630-12SSCK



LIONS GATE

3" BRIDGE WITH CHILL-MAX™

Part Number	Taps	Finish	Cooling	Drip Tray
BB102770-06SSCK	6	Polished SS	Glycol	20"
BB102770-08SSCK	8	Polished SS	Glycol	24"
BB102770-10SSCK	10	Polished SS	Glycol	30"
BB102770-12SSCK	12	Polished SS	Glycol	36"

Air cooled versions of this tower style are also available.

3" WALL-MT RAIL WITH CHILL-MAX™

Part Number	Taps	Finish	Cooling	Drip Tray
BB102765-06SS	6	Polished SS	Air	20"
BB102765-08SS	8	Polished SS	Air	24"
BB102765-10SS	10	Polished SS	Air	30"
BB102765-12SS	12	Polished SS	Air	36"

Glycol cooled versions of this tower style are also available.

4" LIONS GATE WITH CHILL-MAX™

Part Number	Taps	Finish	Cooling	Drip Tray
BB102630-06SSCK	6	Polished SS	Glycol	30"
BB102630-08SSCK	8	Polished SS	Glycol	36"
BB102630-10SSCK	10	Polished SS	Glycol	45"
BB102630-12SSCK	12	Polished SS	Glycol	51"
BB102630-14SSCK	14	Polished SS	Glycol	2 x 30"

Air cooled versions of this tower style are also available.

4" LIT LIONS GATE WITH CHILL-MAX™

Part Number	Taps	Finish	Cooling	Drip Tray
BB102930-06SSCK	6	Polished SS	Glycol	30"
BB102930-08SSCK	8	Polished SS	Glycol	36"
BB102930-10SSCK	10	Polished SS	Glycol	45"
BB102930-12SSCK	12	Polished SS	Glycol	51"
BB102930-14SSCK	14	Polished SS	Glycol	2 x 30"

Air cooled versions of this tower style are also available.

★ MEDALLIONS & TAP HANDLES NOT INCLUDED

★ TAPS SOLD SEPARATELY



BB102930-14SSCK

ALL TOWERS
ON THIS PAGE



ALL PRODUCTS ON THIS PAGE MADE FROM 304SS

DRAUGHT BEER TOWERS: AMERICAN

4" CONDOR WITH CHILL-MAX™

Part Number	Taps	Finish	Cooling	Drip Tray
BB102612-04SSCK	4	Polished SS	Glycol	30"
BB102612-06SSCK	6	Polished SS	Glycol	33"
BB102612-08SSCK	8	Polished SS	Glycol	45"
BB102612-10SSCK	10	Polished SS	Glycol	51"
BB102612-12SSCK	12	Polished SS	Glycol	57"

Air cooled versions of this tower style are also available.



BB102612-06SSCK



CONDOR

4" LIT CONDOR WITH CHILL-MAX™

Part Number	Taps	Finish	Cooling	Drip Tray
BB102912-04SSCK	4	Polished SS	Glycol	30"
BB102912-06SSCK	6	Polished SS	Glycol	33"
BB102912-08SSCK	8	Polished SS	Glycol	45"
BB102912-10SSCK	10	Polished SS	Glycol	51"

Air cooled versions of this tower style are also available.



BB102912-06SSCK

4" LIONS GATE 3P WITH CHILL-MAX™

Part Number	Taps	Finish	Cooling	Drip Tray
BB102635-12SSCK	12	Polished SS	Glycol	2 x 24"
BB102635-16SSCK	16	Polished SS	Glycol	2 x 36"
BB102635-20SSCK	20	Polished SS	Glycol	4 x 20"
BB102635-24SSCK	24	Polished SS	Glycol	2 x 51"

Air cooled versions of this tower style are also available.



BB102635-12SSCK

★ MEDALLIONS & TAP HANDLES NOT INCLUDED

★ TAPS SOLD SEPARATELY

LIONS GATE 3P

ALL TOWERS
ON THIS PAGE





DRAUGHT BEER TOWERS: AMERICAN

DRAUGHT BEER



BB102620-08SSCK



BB102920-04SSCK



BB102615-03SSCK



BB102915-03SSCK

ALL TOWERS
ON THIS PAGE



ALL PRODUCTS ON THIS PAGE MADE FROM 304SS

4" ALBATROSS WITH CHILL-MAX™

Part Number	Taps	Finish	Cooling	Drip Tray
BB102620-04SSCK	4	Polished SS	Glycol	2 x 12"
BB102620-06SSCK	6	Polished SS	Glycol	2 x 12"
BB102620-08SSCK	8	Polished SS	Glycol	2 x 16"
BB102620-10SSCK	10	Polished SS	Glycol	2 x 20"
BB102620-12SSCK	12	Polished SS	Glycol	2 x 24"

Air cooled versions of this tower style are also available.

ALBATROSS

4" LIT ALBATROSS WITH CHILL-MAX™

Part Number	Taps	Finish	Cooling	Drip Tray
BB102920-04SSCK	4	Polished SS	Glycol	2 x 12"
BB102920-06SSCK	6	Polished SS	Glycol	2 x 12"
BB102920-08SSCK	8	Polished SS	Glycol	2 x 16"
BB102920-10SSCK	10	Polished SS	Glycol	2 x 20"

Air cooled versions of this tower style are also available.

4" LINX L7 WITH CHILL-MAX™

Part Number	Taps	Finish	Cooling	Drip Tray
BB102615-02SSCK	2	Polished SS	Glycol	12"
BB102615-03SSCK	3	Polished SS	Glycol	12"
BB102615-04SSCK	4	Polished SS	Glycol	16"
BB102615-05SSCK	5	Polished SS	Glycol	20"
BB102615-06SSCK	6	Polished SS	Glycol	24"

Air cooled versions of this tower style are also available.

LINX L7 & R7

4" LIT LINX L7 WITH CHILL-MAX™

Part Number	Taps	Finish	Cooling	Drip Tray
BB102915-02SSCK	2	Polished SS	Glycol	12"
BB102915-03SSCK	3	Polished SS	Glycol	12"
BB102915-04SSCK	4	Polished SS	Glycol	16"
BB102915-05SSCK	5	Polished SS	Glycol	20"
BB102915-06SSCK	6	Polished SS	Glycol	24"

Air cooled versions of this tower style are also available.

★ MEDALLIONS & TAP HANDLES NOT INCLUDED

★ TAPS SOLD SEPARATELY

DRAUGHT BEER TOWERS: AMERICAN



KRONOS WITH CHILL-MAX™

Part Number	Taps	Finish	Length	Cooling
BB103775-06CK	6	Brushed SS	18"	Glycol
BB103775-08CK	8	Brushed SS	24"	Glycol
BB103775-10CK	10	Brushed SS	30"	Glycol
BB103775-12CK	12	Brushed SS	36"	Glycol

Air cooled versions of this tower style are also available.



BB103775-08CK

KRONOS



KRONOS (GR) WITH CHILL-MAX™

Part Number	Taps	Finish	Length	Cooling
BB103780-06CK	6	Brushed SS	18"	Glycol
BB103780-08CK	8	Brushed SS	24"	Glycol
BB103780-10CK	10	Brushed SS	30"	Glycol
BB103780-12CK	12	Brushed SS	36"	Glycol

Air cooled versions of this tower style are also available.



BB103780-10CK

UNDERBAR

CABINET WITH CHILL-MAX™

Part Number	Taps	Finish	Length	Cooling
BB103720-04CK	4	Brushed SS	20"	Glycol
BB103720-05CK	5	Brushed SS	20"	Glycol
BB103720-06CK	6	Brushed SS	20"	Glycol
BB103724-08CK	8	Brushed SS	24"	Glycol
BB103730-08CK	8	Brushed SS	30"	Glycol
BB103740-10CK	10	Brushed SS	40"	Glycol
BB103740-12CK	12	Brushed SS	40"	Glycol

Air cooled versions of this tower style are also available.



BB103740-12CK

SPACE MIZER WITH CHILL-MAX™

Part Number	Taps	Finish	Length	Cooling	Drip Tray
BB103614-03CK	3	Brushed SS	14"	Glycol	15"
BB103614-04CK	4	Brushed SS	14"	Glycol	15"
BB103620-05CK	5	Brushed SS	20"	Glycol	20"
BB103620-06CK	6	Brushed SS	20"	Glycol	20"
BB103626-08CK	8	Brushed SS	26"	Glycol	24"
BB103632-10CK	10	Brushed SS	32"	Glycol	30"
BB103638-12CK	12	Brushed SS	38"	Glycol	36"

Air cooled versions of this tower style are also available.



BB103614-04CK



ALL TOWERS ON THIS PAGE

★ TAP HANDLES NOT INCLUDED

★ TAPS SOLD SEPARATELY



CHILL-MAX™ TOWER CARTRIDGES



CHILL-MAX™ cooling cartridges include:

- Aluminum blocks
- Refrigerant grade copper
- 304SS product tubes
- PVC & PBA free tubing
- 304SS screw-in shanks
- Chrome outside flanges
- Chrome coupling nuts

CHILL-MAX™ AIR “T” TOWER

Part Number	Taps	Center	Tube Exit	Cooling
CC302XTD-AIR	2	3"	Bottom	Air
CC303XTD-AIR	3	3"	Bottom	Air
CC304XTD-AIR	4	3"	Bottom	Air
CC305XTD-AIR	5	3"	Bottom	Air
CC306XTD-AIR	6	3"	Bottom	Air
CC308XTD-AIR	8	3"	Bottom	Air
CC310XDTD-AIR	10	3"	Bottom	Air
CC312XDTD-AIR	12	3"	Bottom	Air
CC316XDTD-AIR	16	3"	Bottom	Air
CC320XDTD-AIR	20	3"	Bottom	Air

The engineering design process used to create our CHILL-MAX™ cooling cartridge was based on 3 key principles:

PURITY

deliver product the way it was intended to taste

PERFORMANCE

provide superior thermal conductivity with less energy

HASSLE-FREE

lightweight with flexible lines for a quick and easy install



CC3043TD-CLD



CHILL-MAX™ GLYCOL 3” “T” TOWER

Part Number	Taps	Center	Tube Exit	Cooling
CC3033TD-CLD	3	3"	Bottom	Glycol
CC3043TD-CLD	4	3"	Bottom	Glycol
CC3053TD-CLD	5	3"	Bottom	Glycol
CC3063TD-CLD	6	3"	Bottom	Glycol
CC3083TD-CLD	8	3"	Bottom	Glycol

CHILL-MAX™ GLYCOL 4” “T” TOWER

Part Number	Taps	Center	Tube Exit	Cooling
CC3044TD-CLD	4	3"	Bottom	Glycol
CC3054TD-CLD	5	3"	Bottom	Glycol
CC3064TD-CLD	6	3"	Bottom	Glycol
CC3084TD-CLD	8	3"	Bottom	Glycol

CHILL-MAX™ GLYCOL 4” DIA. PIPE TOWER

Part Number	Taps	Center	Tube Exit	Cooling
CC4034PS-CLD	3	4"	Side	Glycol
CC4044PS-CLD	4	4"	Side	Glycol
CC4064PS-CLD	6	4"	Side	Glycol
CC4084PS-CLD	8	4"	Side	Glycol
CC4104PS-CLD	10	4"	Side	Glycol
CC4124PS-CLD	12	4"	Side	Glycol



CC4084PS-CLD

DRAUGHT BEER TOWERS: AMERICAN

3" COLUMN - AIR TAPS INCLUDED

Part Number	Taps	Faucet Style	Finish	Tubing	Drip Tray
BB101402	1	Chrome	Polished SS	Vinyl	10"
BB101403	1	Brass	Brass	Vinyl	10"
BB101404	1	Chrome	Polished SS	Stainless Steel	10"
BB101405	1	Brass	Brass	Stainless Steel	10"
BB101406	2	Chrome	Polished SS	Vinyl	10"
BB101407	2	Brass	Brass	Vinyl	10"
BB101408	2	Chrome	Polished SS	Stainless Steel	10"
BB101409	2	Brass	Brass	Stainless Steel	10"
BB101419	3	Chrome	Polished SS	Vinyl	10"
BB101420	3	Brass	Brass	Vinyl	10"

Glycol cooled versions of this tower style are also available.



BB101402



BB101406



BB101419



BB101407



BB101420

3" COLUMN 304SS TAPS INCLUDED - Recommended for beer & cider

Part Number	Taps	Faucet Style	Finish	Tubing	Drip Tray
BB125402C	1	304SS	Polished SS	Ultra Barrier	10"
BB125406C	2	304SS	Polished SS	Ultra Barrier	10"
BB125419C	3	304SS	Polished SS	Ultra Barrier	10"

Glycol cooled versions of this tower style are also available.

COLUMN

Ultra Barrier is a highly flexible, PVC/BPA free, food grade tubing made from FDA approved materials.

3" SINGLE METAL COLUMN ADDITIONS

Part Number	Taps	Drip Tray
BB101397-1	Add 1 Tap to a 2 Tap 3" Tower	10"
BB101397-2	Add 2 Taps to a 1 Tap 3" Tower	10"
BB101398	Add 1 Tap to a 1 Tap 3" Tower	10"



BB101397-1



BB101397-2



BB101398



 TAPS SOLD SEPARATELY

4" COLUMN - AIR TAPS INCLUDED

Part Number	Taps	Faucet Style	Finish	Tubing	Drip Tray	Cut-Out
BB101412-B	3	Brass	Brass	Vinyl	12"	X
BB101412-C	3	Chrome	Polished SS	Vinyl	12"	X
BB101412-SS	3	Chrome	Polished SS	Vinyl	12"	X
BB101422-B	4	Brass	Brass	Vinyl	14"	6"
BB101422-C	4	Chrome	Polished SS	Vinyl	14"	6"
BB101422-SS	4	Chrome	Polished SS	Vinyl	14"	6"

Glycol cooled versions of this tower style are also available.

 TAP HANDLES NOT INCLUDED



BB101422-C



BB700795



BB700812



BB701912



BB701462



BB701320



BB701351

STAINLESS STEEL - 5 3/8" WIDE

Part Number	L	W	H	Drain
BB700795	5"	5 3/8"	3/4"	X
BB700802	10 3/8"	5 3/8"	3/4"	X
BB700808	12"	5 3/8"	3/4"	X
BB700812	15"	5 3/8"	3/4"	X
BB700817	20"	5 3/8"	3/4"	X
BB700822	24"	5 3/8"	3/4"	X
BB700832	30 1/4"	5 3/8"	3/4"	X
BB701902	10 3/8"	5 3/8"	3/4"	✓
BB701908	12"	5 3/8"	3/4"	✓
BB701912	15"	5 3/8"	3/4"	✓
BB701917	20"	5 3/8"	3/4"	✓
BB701922	24"	5 3/8"	3/4"	✓
BB701932	30 1/4"	5 3/8"	3/4"	✓
BB701937	33"	5 3/8"	3/4"	✓
BB701942	36 1/4"	5 3/8"	3/4"	✓
BB701947	39"	5 3/8"	3/4"	✓
BB701952	45 1/4"	5 3/8"	3/4"	✓
BB701962	51"	5 3/8"	3/4"	✓

RECESSED DRIP TRAY

Part Number	L	W	H	Drain
BB701462	12"	5"	3/4"	✓

CBS designed drip tray inserts feature an offset hole pattern to maximize drainage!

STAINLESS STEEL - 7" WIDE

Part Number	L	W	H	Drain
BB701312	12"	7"	7/8"	✓
BB701316	16"	7"	7/8"	✓
BB701320	20"	7"	7/8"	✓
BB701324	24"	7"	7/8"	✓
BB701330	30"	7"	7/8"	✓
BB701336	36"	7"	7/8"	✓
BB701339	39"	7"	7/8"	✓
BB701345	45"	7"	7/8"	✓
BB701351	51"	7"	7/8"	✓



DRIP TRAYS

STAINLESS STEEL WITH CUT-OUT

Part Number	L	W	H	Cut-Out	Drain
BB701005	15"	7 1/2"	7/8"	4 1/2"	X
BB701020	18"	9"	7/8"	6 1/4"	X
BB701061S	19 3/4"	10"	7/8"	8 1/4"	X
BB701108	14"	8"	3/4"	6"	✓
BB701110	15"	7 1/2"	7/8"	4 1/2"	✓
BB701125	18"	9"	7/8"	6 1/4"	✓
BB701135	19"	9"	7/8"	6 1/4"	✓
BB701150	19 3/4"	10"	7/8"	8 1/4"	✓
BB701165	24"	11"	7/8"	7 1/2"	✓



BB701020

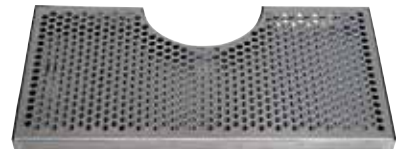

BB701125

BRASS WITH CUT-OUT

Part Number	L	W	H	Cut-Out	Drain
BB701208	14"	8"	3/4"	6"	✓
BB701235	19"	9"	7/8"	6 1/4"	✓
BB701265	24"	11"	7/8"	7 1/2"	✓

STAINLESS STEEL - WITH GLASS RINSER

Part Number	L	W	H	Glass Rinsers
BB702408	8"	8"	7/8"	Center
BB702412	12"	7"	7/8"	Center
BB702416	16"	7"	7/8"	Side
BB702420	20"	7"	7/8"	Side
BB702424	24"	7"	7/8"	Side
BB702430	30"	7"	7/8"	Side
BB702436	36"	7"	7/8"	Side
BB702439	39"	7"	7/8"	Side
BB702445	45"	7"	7/8"	Side
BB702451	51"	7"	7/8"	Side

STAINLESS STEEL TRAYS WITH CUT-OUT AND GLASS RINSER

Part Number	L	W	H	Cut-Out	Glass Rinsers
BB702110	15"	7 1/2"	7/8"	4 1/2"	Side
BB702125	18"	9"	7/8"	6 1/4"	Side
BB702150	19 3/4"	10"	7/8"	8 1/4"	Side
BB702160	22"	11"	7/8"	7 1/4"	Side
BB702163	24"	8"	7/8"	6"	Side
BB702180	34"	8"	7/8"	6"	Side



BB702424



BB702416



BB702110

CBS INNOVATION

All CBS designed drip trays have been engineered to withstand the rigors and demands of the busiest foodservice operations. Our "no sag" inserts are fabricated from 18ga. Stainless Steel with returns on all four sides for maximum support.



BB702408



GLASS RINSER TRAY INSERTS ARE PUNCHED, DEBURRED & FLARED FOR MAXIMUM SAFETY





BB700070

BB700071

BB700073



BB701694

BB701695

STAINLESS STEEL EUROPEAN WITH GLASS RINSER

Part Number	Length	Width	Holes
BB700080	15 3/4"	15 3/4"	None
BB700080-1	15 3/4"	15 3/4"	1
BB700080-2	15 3/4"	15 3/4"	2
BB700081	19 11/16"	15 3/4"	None
BB700081-1	19 11/16"	15 3/4"	1
BB700081-2	19 11/16"	15 3/4"	2
BB700083	27 11/16"	15 3/4"	None
BB700083-1	27 9/16"	15 3/4"	1
BB700083-2	27 9/16"	15 3/4"	2
BB700083-3	27 9/16"	15 3/4"	3
BB700083-4	27 9/16"	15 3/4"	4
BB700084	31 1/2"	15 3/4"	None
BB700086	39 1/2"	19 11/16"	None
BB700087	47 1/4"	19 11/16"	None

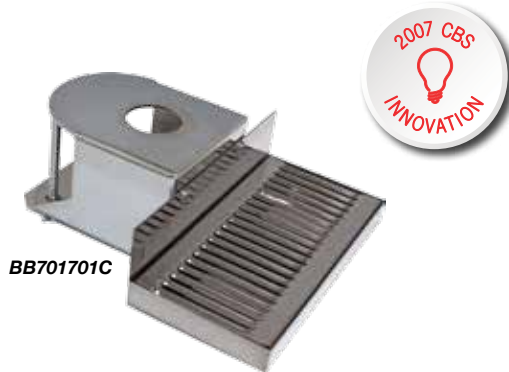

BB701701C

CLAMP-ON TOWER BRACKET WITH DRIP TRAY

Part Number	Description
BB701694	Chrome Clamp On Bracket With SS Drip Tray for 1T 3" Column
BB701695	Chrome Clamp On Bracket with SS Drip Tray for Euro Tower
BB701701C	Chrome Clamp On Bracket with 10" SS Drip Tray-use with 2 or 3T Euro Tower
BB701702C	Chrome Clamp On Bracket with 10" SS Drip Tray-use with 2 or 3T 3" Column



BB103121CC

CLAMP-ON TOWERS

Part Number	Description
BB103121CC	3" Dia. Single Tap Chrome Tower with Chrome Clamp-On Bracket & Drip Tray
BB103122CC	3" Dia. 2 Tap Chrome Tower with Chrome Clamp-On Bracket & Drip Tray

★ TAP HANDLES NOT INCLUDED



BB101177

UNDERCOUNTER MOUNT WITH GLASS RINSER

Part Number	Description
BB101177	8" x 8" Tray comes complete with: · Stainless Steel Insert · Sprayer Assembly · Tubing & Fittings · Mounting Hardware

WALL MOUNT DRIP TRAYS

STAINLESS STEEL WALL MOUNTED DRIP TRAYS

Part Number	L	W	H	Drain
BB700049	5 5/8"	5 5/8"	1 1/4"	X
BB700050-06	6"	4"	3"	X
BB700050-10	10"	5"	1 1/4"	X



STAINLESS STEEL WALL MOUNTED DRIP TRAYS

Part Number	L	W	H	Drain
BB700048	5 5/8"	5 5/8"	1 1/4"	✓



STAINLESS STEEL WALL MOUNTED DRIP TRAYS

Part Number	L	W	H	Hole(s)	Drain
BB700051-JB	6"	6"	11"	1	✓
BB700051-0	8"	6 3/8"	14"	0	✓
BB700051-1	8"	6 3/8"	14"	1	✓
BB700051-2	8"	6 3/8"	14"	2	✓
BB700053-0	12"	6 3/8"	14"	0	✓
BB700053-1	12"	6 3/8"	14"	1	✓
BB700053-2	12"	6 3/8"	14"	2	✓
BB700053-3	12"	6 3/8"	14"	3	✓
BB700053-4	12"	6 3/8"	14"	4	✓
BB700055-4	16"	6 3/8"	14"	4	✓
BB700055-5	16"	6 3/8"	14"	5	✓
BB700056-6	24"	6 3/8"	14"	6	✓
BB700056-8	24"	6 3/8"	14"	8	✓
BB700057-08	30"	6 3/8"	14"	8	✓
BB700057-10	30"	6 3/8"	14"	10	✓
BB700058-12	36"	6 3/8"	14"	12	✓
BB700059-14	48"	6 3/8"	14"	14	✓
BB700059-16	48"	6 3/8"	14"	16	✓



DRIP TRAY ACCESSORIES



Part Number	Description
BB101186	Drain Nut with 1/2" Nipple
BB101184	Drain Assembly for True Direct Draw Cabinets
BB101185	Drain Flange Adaptor with 1/2" Angled Spout
BB101186	4" Brass Drain with Lock Nut and Washer
BB101187	2" Brass Drain with Lock Nut and Washer
BB101188	1 1/8" Brass Drain with Lock Nut and Washer
QD100633	1/2" BSP x 3/8" OD Tube Water Connection
MP551825	1/4" X 1/4" Plastic Shut-Off
MP551830	1/4" X 3/8" Plastic Shut-Off
MP551837	3/8" X 3/8" Plastic Shut-Off
SF143325	1/4" x 1/4" x 1/4" SS Tee
WF006250	6" In-Line Water Filter - 1/4" FMPT
QD505375	3/8" Compression x 3/8" OD Valve

GLASS RINSER ASSEMBLIES

Part Number	Description
BB101174	Heavy Duty Spray Assembly (Black Plate)
BB101175	Heavy Duty Spray Assembly (Stainless Steel Plate)
BB101178-MTL	Metal Spray Assembly (Vinyl Sleeves)
BB101179	Standard Spray Assembly (Plastic Star)

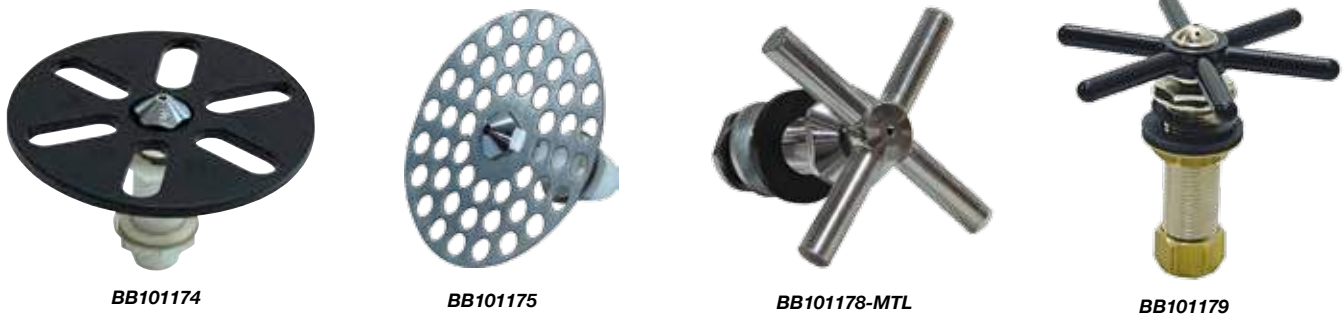

GLASS RINSER REPLACEMENT PARTS

Part Number	Description
BB101174-PLT	Plastic Plate for BB101174
BB101175-PLT	Stainless Steel Plate for BB101175
BB101179-STAR	Plastic Star for BB101179

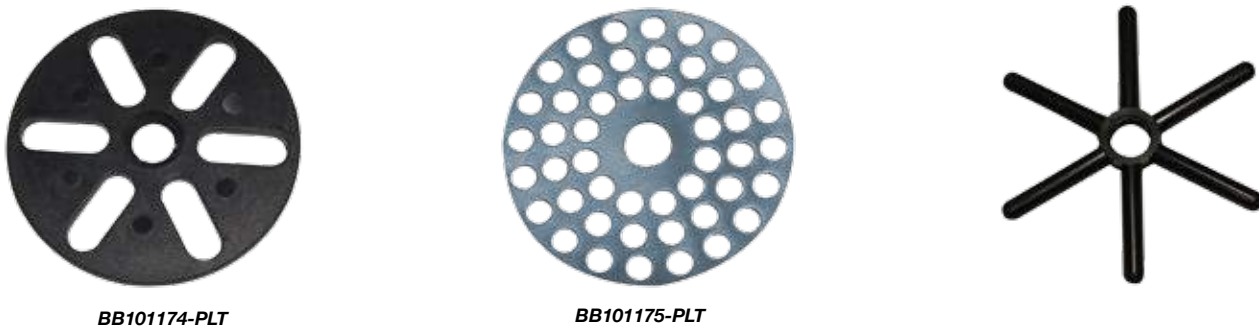

WALL MOUNT DISPENSERS

STAINLESS STEEL WALL MOUNT DRIP TRAY WITH GLASS RINSER

Part Number	L	W	H	Holes	Centers
BB700115-04	16"	8"	17"	4	4"
BB700115-06	24"	8"	17"	6	4"
BB700115-08	32"	8"	17"	8	4"
BB700115-10	40"	8"	17"	10	4"
BB700115-12	48"	8"	17"	12	4"



GLASS RINSER TRAY INSERTS ARE PUNCHED, DEBURRED & FLARED FOR MAXIMUM SAFETY



BB700115-06

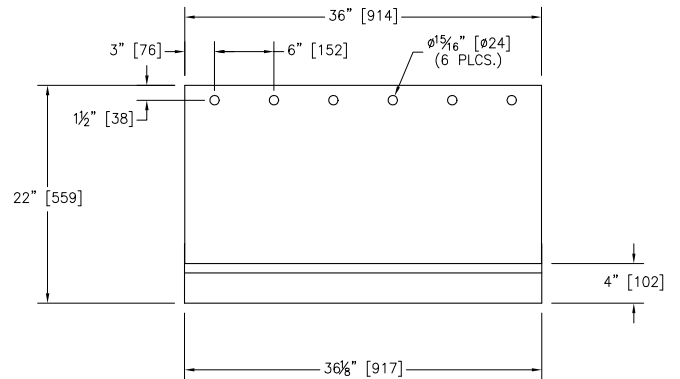

STAINLESS STEEL WALL MOUNT GROWLER FILLER WITH GLASS RINSER

Part Number	L	W	H	Holes	Centers
BB700138-02	12"	8"	22"	2	6"
BB700138-03	18"	8"	22"	3	6"
BB700138-04	24"	8"	22"	4	6"
BB700138-05	30"	8"	22"	5	6"
BB700138-06	36"	8"	22"	6	6"
BB700138-07	42"	8"	22"	7	6"
BB700138-08	48"	8"	22"	8	6"

★ TAP HANDLES NOT INCLUDED

★ TAPS & SHANKS SOLD SEPARATELY



BB700138-05



CHILL-MAX™ WALL-MOUNT CARTRIDGES

CHILL-MAX™ AIR WALL-MOUNT CARTRIDGE



CHILL-MAX™ cooling cartridges include:

- Aluminum blocks
- Refrigerant grade copper
- 304SS product tubes
- PVC & PBA free tubing
- 304SS screw-in shanks
- Chrome outside flanges
- Chrome coupling nuts

Part Number	Taps	Shank Length	Center	Tube Exit	Cooling
CC3060WB-AIR	6	2 3/4"	3"	Center	Air
CC3080WB-AIR	8	2 3/4"	3"	Center	Air
CC3100WB-AIR	10	2 3/4"	3"	Center	Air
CC3120WB-AIR	12	2 3/4"	3"	Center	Air
CC3140WB-AIR	14	2 3/4"	3"	Center	Air
CC3160WB-AIR	16	2 3/4"	3"	Center	Air
CC4040WB-AIR	4	2 3/4"	4"	Center	Air
CC4060WB-AIR	6	2 3/4"	4"	Center	Air
CC4080WB-AIR	8	2 3/4"	4"	Center	Air
CC4100WB-AIR	10	2 3/4"	4"	Center	Air
CC4120WB-AIR	12	2 3/4"	4"	Center	Air
CC6020WB-AIR	2	2 3/4"	6"	Center	Air
CC6030WB-AIR	3	2 3/4"	6"	Center	Air
CC6040WB-AIR	4	2 3/4"	6"	Center	Air
CC6050WB-AIR	5	2 3/4"	6"	Center	Air
CC6060WB-AIR	6	2 3/4"	6"	Center	Air
CC6070WB-AIR	7	2 3/4"	6"	Center	Air
CC6080WB-AIR	8	2 3/4"	6"	Center	Air

The engineering design process used to create our CHILL-MAX™ cooling cartridge was based on 3 key principles:

PURITY

deliver product the way it was intended to taste

- 304SS Shanks
- PVC & PBA free tubing
- 304SS Product tubes

PERFORMANCE

provide superior thermal conductivity with less energy

- Aircraft grade aluminum blocks
- Refrigerant grade copper
- Innovative foam insulation

HASSLE-FREE

lightweight with flexible lines for a quick and easy install

- Screw-in shanks
- Flexible product tubes
- Lightweight design

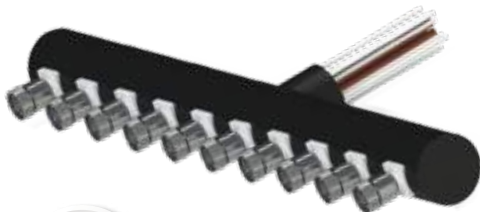

CC4100WB-CLD



CHILL-MAX™ GLYCOL WALL-MOUNT CARTRIDGE

Part Number	Taps	Shank Length	Center	Tube Exit	Cooling
CC4040WB-CLD	4	2 3/4"	4"	Center	Glycol
CC4060WB-CLD	6	2 3/4"	4"	Center	Glycol
CC4080WB-CLD	8	2 3/4"	4"	Center	Glycol
CC4100WB-CLD	10	2 3/4"	4"	Center	Glycol
CC4120WB-CLD	12	2 3/4"	4"	Center	Glycol
CC6020WB-CLD	2	2 3/4"	6"	Center	Glycol
CC6030WB-CLD	3	2 3/4"	6"	Center	Glycol
CC6040WB-CLD	4	2 3/4"	6"	Center	Glycol
CC6050WB-CLD	5	2 3/4"	6"	Center	Glycol
CC6060WB-CLD	6	2 3/4"	6"	Center	Glycol
CC6070WB-CLD	7	2 3/4"	6"	Center	Glycol
CC6080WB-CLD	8	2 3/4"	6"	Center	Glycol

FAUCETS

EUROPEAN FAUCETS - COMPATIBLE WITH US COUPLING NUTS

Part Number	Description
BB101202-SS	304SS Euro Flow Control Faucet - Fits Standard US Coupling Nut
BB101223	Chr. Plated Euro Spherix Faucet - Fits Standard US Coupling Nut
BB101228	316SS Euro Faucet - Fits Standard US Coupling Nut
BB101232	304SS Euro Quix Faucet - Fits Standard US Coupling Nut
BB101233	Gold Plated Euro Faucet - Fits Standard US Coupling Nut
BB101234	Chr. Plated Euro Faucet - Fits Standard US Coupling Nut



EUROPEAN FAUCETS

Part Number	Description
BB101221C	Chr. Plated Euro Flow Control Faucet
BB101221G	Gold Plated Euro Flow Control Faucet
BB101225	Chr. Plated Ball Valve Faucet with SS Nozzle
BB101231	304SS Euro Flow Control Faucet with Shank
BB101198	316LSS Flux Flow Control Faucet with Shank

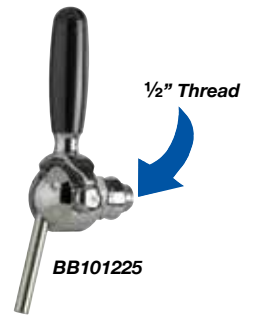
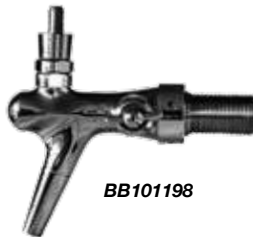

STOUT FAUCETS

Part Number	Description
BB101254	Polished 303SS Stout Faucet
BB101254-G	Gold Plated 303SS Stout Faucet
BB101196	Polished 316SS Stout Faucet
BB101196-G	Gold Plated 316SS Stout Faucet



PERLICK® STAINLESS STEEL FAUCETS

Part Number	Description
BB101212-SS	304SS Perlick 630SS Faucet
BB101214-SS	304SS Perlick 650SS Flow Control Faucet



★ TAP HANDLES NOT INCLUDED



PLASTIC FAUCETS

Part Number	Description
BB101236	Burgundy Wine Faucet with Chrome Nozzle
BB101236HD	Burgundy Wine Faucet with Chrome Tap Handle
BB101237	Black Wine Faucet with Chrome Nozzle
BB101237HD	Black Wine Faucet with Chrome Tap Handle
BB101239	White Wine Faucet with Chrome Nozzle
BB101239HD	White Wine Faucet with Chrome Tap Handle



CHROME PLATED DOMESTIC FAUCETS

Part Number	Description
BB101245	Economy Chrome Plated Faucet with Brass Lever
BB101252	Chrome Plated Faucet with Brass Lever
BB101250	Chrome Plated Faucet with Stainless Steel Lever



POLISHED BRASS DOMESTIC FAUCETS

Part Number	Description
BB101253	Polished Brass Faucet with Brass Lever
BB101251	Polished Brass Faucet with Stainless Steel Lever

SS AND GOLD PLATED DOMESTIC FAUCETS

Part Number	Description
BB101246	Economy 304SS Faucet
BB101247	304SS Faucet
BB101248	303SS Faucet-not recommended for wine or cider
BB101249	Gold Plated Faucet with Brass Lever

DOMESTIC FAUCET REPLACEMENT PARTS

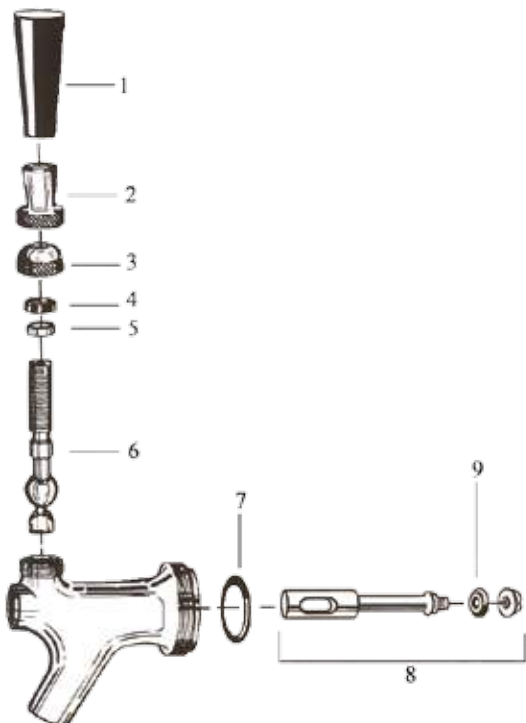

Item	Part Number	Description
1	BB101255	Black Faucet Knob
1	BB101260	Chrome Plated Faucet Knob
2	BB101265	Lever Collar
2	BB101264	Brass Lever Collar
3	BB101266	Lever Bonnet
3	BB101263	Brass Lever Bonnet
4	BB101267	Friction Washer
5	BB101268	Ball Washer
6	BB101269	Brass Lever
6	BB101270	Stainless Steel Lever
7	BB101271	Coupling Washer
8	BB101272	Chrome Shaft Assembly
8	BB101272-SS	304SS Shaft Assembly
8	BB101273	Brass Shaft Assembly
9	BB101262	Valve Seat

FAUCETS

STOUT FAUCET REPLACEMENT PARTS

Part Number	Description
BB101254-KIT	Stout Faucet Nozzle Kit
BB101254-BD	Stout Faucet Diaphragm
BB101254-25	Stout Faucet Creamer Plate-.25mm
BB101254-30	Stout Faucet Creamer Plate-.30mm
BB101254-FS	Stout Faucet Flow Straightener
BB101254-OR	Stout Faucet BS 013 O'Ring



FAUCET LOCKS

Part Number	Description
BB700405	Metal Faucet Lock
BB700407	Metal Faucet Lock - Celli (US)
BB700415	Perlick Faucet Lock
BB700420	Stout Faucet Lock - Padlock not included



TAP HANDLE EXTENSIONS

Part Number	Description
BB700428-C	1" Chrome Knob Extension
BB700429-C	2" Chrome Knob Extension
BB700430-B	Brass Angled Tap Extension
BB700430-C	Chrome Angled Tap Extension



FAUCET PLUG

Part Number	Description
BB101435	Faucet Plug

SPOUT CAPS

Part Number	Description
CP101550	Faucet Spout Cap for Domestic Faucets
CP101555	Faucet Spout Cap for European Taps with SS Nozzles



KLEEN PLUG™

Part Number	Description
CP101525	Durable Brush and Plug keeps fruit flies out of beer taps

FAUCET CLEANING BRUSH

Part Number	Description
CP101712	8" x 3/4" Cleaning Brush



Kleen-Plug-use to keep fruit flies out of beer taps. Stepped design fits all beer tap sizes.



BB101316



BB101302



BB101295-4SS



BB101333

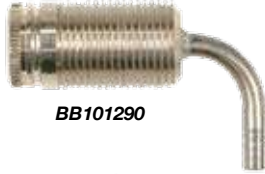

BB101290



BB101291



BB101297-SS



BB101293



BB101293-NS

NIPPLE SHANK ASSEMBLIES

Part Number	Description
BB101293	1 3/4" 304SS Shank with 3/16" Barb Elbow
BB101293-NS	1 3/4" 304SS Shank with 3/16" Barb Straight
BB101293-WW	1 3/4" 304SS Shank with 1/4" Barb Elbow
BB101297-SS	2 1/2" 304SS Shank with 3/16" Barb Straight

NIPPLE SHANKS

Part Number	Description
BB101287-SS	1 3/4" 304SS Shank with 3/16" Barb Elbow
BB101288-SS	1 3/4" 304SS Shank with 1/4" Barb Straight
BB101289-SS	1 3/4" 304SS Shank with 3/16" Barb Straight
BB101296-SS	2 1/2" 304SS Shank with 3/16" Barb Straight

TOWER SHANKS

Part Number	Description
BB101290	1 3/4" Shank with 3/16" Barb Elbow
BB101291	1 3/4" Shank with 3/16" Barb Straight
BB101296	2 1/2" Shank with 3/16" Barb Straight

5/8" BSP EURO TOWER SHANKS

Part Number	Description
BB101306-SS	1 1/16" 304SS Shank
BB101307-SS	1 7/8" 304SS Shank

DOUBLE FAUCET SHANKS

Part Number	Description
BB101314	2" Chrome Plated with 3/16" Tailpieces
BB101315	4" Chrome Plated with 3/16" Tailpieces
BB101316	6" Chrome Plated with 3/16" Tailpieces

SHANK ASSEMBLIES

Part Number	Description
BB101300	3" Shank with 3/16" Bore
BB101300-1/4	3" Shank with 1/4" Bore
BB101301	4 1/8" Shank with 3/16" Bore
BB101301A	5 1/8" Shank with 3/16" Bore
BB101302	6" Shank with 3/16" Bore
BB101303	8" Shank with 3/16" Bore
BB101303A	10" Shank with 3/16" Bore
BB101304	12" Shank with 1/4" Bore
BB101305	14" Shank with 1/4" Bore
BB101305-24	Extra long shank to be used in walls up to 24" thick

SHANKS ASSEMBLIES

Part Number	Description
BB101295-3SS	3 1/8" 304SS Shank Assembly with 1/4" Bore
BB101295-4SS	4 1/8" 304SS Shank Assembly with 1/4" Bore
BB101295-5SS	5 1/8" 304SS Shank Assembly with 1/4" Bore
BB101295-6SS	6 1/8" 304SS Shank Assembly with 1/4" Bore
BB101295-8SS	8 1/8" 304SS Shank Assembly with 1/4" Bore

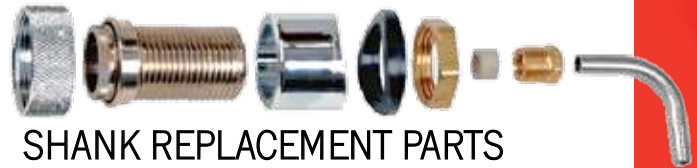

SHANK REPLACEMENT PARTS

Part Number	Description
BB101276	Compression Nut
BB101277	Grommet/Gland
BB101278	Lock Nut for Tower
BB101279	7/8" Zinc Lock Washer
BB101282-B	Brass Outer Flange
BB101282-C	Chrome Outer Flange - 3" Dia.
SF250100	SS 3/16" Tube x 3/16" Barb Elbow
BB101333	Brass Lock Nut
BB101331	Stainless Steel Flange
BB101328	Chrome Coupling Nut
BB101329	Brass Coupling Nut
BB101329G	Gold Coupling Nut
BB101326	Sleeve
BB101325	Snap Ring
BB501000-C	Chrome Outer Flange - 4" Dia.

TOOLS

FAUCET WRENCHES

Part Number	Description
BB101719	Faucet Wrench
BB101721	Deluxe Faucet Wrench
BB101725	Euro Faucet Wrench
BB101726	Perlick Faucet Wrench
BB101727	6 in 1 Perlick Combination Wrench



TOWER WRENCH

Part Number	Description
BB101722	SS Tower Wrench



CO₂ - N₂ PRIMARY REGULATOR WRENCH

Part Number	Description
CO898804	CO ₂ Wrench



PINCERS

Part Number	Description
MP559995	Straight Jaw Pincer
MP559999	Side Jaw Pincer
MP559996	Oetiker Straight Jaw Pincer
MP560000	Oetiker Side Jaw Pincer



THERMOMETERS

Part Number	Description
BB330020	1" Dial Thermometer
BB330021	Digital Thermometer
BB330025	Taylor Digital Waterproof Thermometer
BB330027	Comark Digital Waterproof Thermometer



POCKET HOSE CUTTER

Part Number	Description
MP559970	Pocket Hose Cutter
MP559971	Pocket Hose Cutter Blade (Each)



MULTI-CUTTER

Part Number	Description
MP559950	Multi-Cutter
MP559951	Multi-Cutter Blade (Each)



JUMBO BUNDLE CUTTER

Part Number	Description
MP559960	Jumbo Bundle Cutter





METAL TAP HANDLES

Part Number	Description
BB101260	Chrome Metal Tap Handle - 2 1/2" Tall
BB101260-XL	Chrome Alloy Tap Handle - 2 1/2" Tall



PLASTIC TAP HANDLES

Part Number	Description
BB101255	Black Plastic Tap Handle - 2 3/4" Tall
BB101258-B	Black Plastic Tap Handle - 2 1/2" Tall
BB101259-B	Clear Tap Handle with Black Base - 3 1/4" Tall
BB101261-BLK	Black Plastic Tap Handle - 3 1/4" Tall
BB101261-CHR	Chrome Plastic Tap Handle - 3 1/4" Tall
BB101261-GLD	Gold Plastic Tap Handle - 3 1/4" Tall
BB100301-B	Ergo Black Plastic Tap Handle - 4" Tall
BB100301-C	Ergo Chrome Plastic Tap Handle - 4" Tall



CBS offers Tap Handles in many shapes, sizes and colors. Our in-house Graphics and Print department specializes in short turnarounds on custom branding and finishing. Contact your CBS Sales Rep for more details.



 FINISHED WITH AIRCRAFT GRADE PAINT



TAP HANDLES

SMALL PUB TAP HANDLES

Part Number	Description
X920101	White Small Pub with Chrome Fittings
X920101-BR	Branded White Small Pub with Chrome Fittings
X920101-OS-BR	Branded White Small Pub with Chrome Oval Shield and Chrome Fittings
X920102	Black Small Pub with Chrome Fittings
X920102-BR	Branded Black Small Pub with Chrome Fittings
X920102-OS-BR	Branded Black Small Pub with Chrome Oval Shield and Chrome Fittings



X920101



X920102



X920101-BR



X920102-OS-BR

SHOTGUN 2.0 TAP HANDLES

Part Number	Description
X919051-BR	Branded White Shotgun 2.0 with Chrome Base
X919052-BR	Branded Black Shotgun 2.0 with Chrome Base
X919053-BR	Branded Blue PMS 288 Shotgun 2.0 with Chrome Base
X919054-BR	Branded Red PMS 186 Shotgun 2.0 with Chrome Base
X919055-BR	Branded Green PMS 347 Shotgun 2.0 with Chrome Base



X919051-BR



X919052-BR



X919053-BR



X919054-BR



X919055-BR

TOBIE TAP HANDLES

Part Number	Description
X898799W-C	White Tobie with Chrome Base
X898799W-CBR	Branded White Tobie with Chrome Base
X898799B-C	Black Tobie with Chrome Base
X898799B-CBR	Branded Black Tobie with Chrome Base



X898799W-C



X898799B-C



X898799W-CBR

Expand your brand visibility by adding your logo to any of our stock Tap Handles.

★ 3 SIDED PRINT AVAILABLE ON TOBIE TAP HANDLES

LARGE PUB TAP HANDLES

Part Number	Description
X920201	White Large Pub with Chrome Fittings
X920201-OS-BR	Branded White Large Pub with Chrome Oval Shield and Chrome Fittings
X920201-RT	White Large Pub with Chrome Round Top and Chrome Base
X920201-RT-BR	Branded White Large Pub with Chrome Round Top and Chrome Base
X920201-RDS-BR	Branded White Large Pub with Chrome Oval Shield, Round Top and Chrome Base
X920202	Black Large Pub with Chrome Fittings
X920202-OS-BR	Branded Black Large Pub with Chrome Oval Shield and Chrome Fittings
X920202-RT	Black Large Pub with Chrome Round Top and Chrome Base
X920202-RT-BR	Branded Black Large Pub with Chrome Round Top and Chrome Base
X920202-RDS-BR	Branded Black Large Pub with Chrome Oval Shield, Round Top and Chrome Base



X920201



X920202



X920201-OS-BR



X920202-OS-BR



X920201-RT



X920202-RT



X920201-RT-BR



X920201-RDS-BR

★ GOLD FITTINGS AVAILABLE UPON REQUEST

ROUND CONICAL TAP HANDLES



Part Number	Description
X920210B-C	Black Round Conical with Chrome Fittings
X920210B-BR	Branded Black Round Conical with Chrome Fittings
X920210W-C	White Round Conical with Chrome Fittings
X920210W-BR	Branded White Round Conical with Chrome Fittings
X933611-BR	Branded Natural Chalkboard Round Conical with Chrome Fittings

X933611-BR X920210W-BR X920210B-C X920210W-C



PADDLE CONICAL TAP HANDLES

Part Number	Description
X920214B-C	Black Paddle Conical with Chrome Fittings
X920214B-BR	Branded Black Paddle Conical with Chrome Fittings
X920214W-C	White Paddle Conical with Chrome Fittings
X920214W-BR	Branded White Paddle Conical with Chrome Fittings
X933601-BR	Branded Natural Chalkboard Paddle Conical with Chrome Fittings

X933601-BR X920214B-BR X920214B-C X920214W-C



TRAP-Z TAP HANDLES

Part Number	Description
X919021	White Trap-Z with Chrome Base
X919021-BR	Branded White Trap-Z with Chrome Base
X919022	Black Trap-Z with Chrome Base
X919022-BR	Branded Black Trap-Z with Chrome Base
X933521-BR	Branded Natural Chalkboard Trap Z with Chrome Base

★ 4 SIDED PRINT AVAILABLE ON TRAP Z AND BATON TAP HANDLES



BATON TAP HANDLES

Part Number	Description
X919001	White Baton with Chrome Base
X919001-BR	Branded White Baton with Chrome Base
X919002	Black Baton with Chrome Base
X919002-BR	Branded Black Baton with Chrome Base
X933501-BR	Branded Natural Chalkboard Baton with Chrome Base

X933501-BR X919002-BR X919002 X919001

TAP HANDLES

OUTRIGGER TAP HANDLES

Part Number	Description
X919011	White Outrigger with Chrome Base
X919011-BR	Branded White Outrigger with Chrome Base
X919012	Black Outrigger with Chrome Base
X919012-BR	Branded Black Outrigger with Chrome Base
X933511-BR	Branded Natural Chalkboard Outrigger with Chrome Base



X919011



X919012



X919011-BR



X933511-BR

T-BIRD TAP HANDLES

Part Number	Description
X919031	White T-Bird with Chrome Base
X919031-BR	Branded White T-Bird with Chrome Base
X919032	Black T-Bird with Chrome Base
X919032-BR	Branded Black T-Bird with Chrome Base
X933531-BR	Branded Natural Chalkboard T-Bird with Chrome Base



X919031



X919032



X919031-BR



X933531-BR

TORCH TAP HANDLES

Part Number	Description
X919161	White Torch with Chrome Base
X919161-BR	Branded White Torch with Chrome Base
X919162	Black Torch with Chrome Base
X919162-BR	Branded Black Torch with Chrome Base



X919161



X919162



X919161-BR

★ 4 SIDED PRINT AVAILABLE ON TORCH AND MAGNUM TAP HANDLES

MAGNUM TAP HANDLES

Part Number	Description
X919181	White Magnum with Chrome Base
X919181-BR	Branded White Magnum with Chrome Base
X919182	Black Magnum with Chrome Base
X919182-BR	Branded Black Magnum with Chrome Base
X933581-BR	Branded Natural Chalkboard Magnum with Chrome Base



X919181



X919182



X919181-BR



X933581-BR



X919211-BR



X919212



X919211

TRIUMPH TAP HANDLES

Part Number	Description
X919211	White Triumph with Chrome Base
X919211-BR	Branded White Triumph with Chrome Base
X919212	Black Triumph with Chrome Base
X919212-BR	Branded Black Triumph with Chrome Base



X933571-BR



X919172-BR



X919172



X919171

VICTORY TAP HANDLES

Part Number	Description
X919171	White Victory with Chrome Base
X919171-BR	Branded White Victory with Chrome Base
X919172	Black Victory with Chrome Base
X919172-BR	Branded Black Victory with Chrome Base
X933571-BR	Branded Natural Chalkboard Victory with Chrome Base



X919262



X919262-BR



X919252-BR



X919252

WINE BOTTLE TAP HANDLES

Part Number	Description
X919262	White Wine Bottle with Chrome Base
X919262-BR	Branded White Wine Bottle with Chrome Base
X919252	Red Wine Bottle with Chrome Base
X919252-BR	Branded Red Wine Bottle with Chrome Base



BRANDED MEDALLIONS

CERAMIC



X900500

LIT DOME

CERAMIC MEDALLION

Part Number	Description
X900150	Branded 82mm Diameter White Ceramic Medallion

PLASTIC DOME FOR LIT TOWER

Part Number	Description
X900500	Branded Lit Dome fits 80 and 82mm Lit Medallion Holders

CLEAR ACRYLIC FISH EYE MEDALLIONS

Part Number	Description
X900206	Branded 60mm Diameter Fish Eye-Use in Vin Service's 4 Tap Lit Sexy
X900210	Branded 80mm Diameter Fish Eye-Use in Vin Service Lit Towers
X900220	Branded 82mm Diameter Fish Eye Medallion

X900150



X900206

X900220



Snaps into Vin Service and Perlick Illuminated Towers – no tape required!



X900210

FISH EYE





OVAL VERTICAL MEDALLION ASSEMBLIES

Part Number	Description
BB501100	Chrome Oval Medallion Holder with Angled Support
BB501105B	Dark Nickel Short Medallion Holder
BB501105C	Chrome Short Medallion Holder
BB501105G	Gold Short Medallion Holder
BB501107B	Dark Nickel Tall Medallion Holder
BB501107C	Chrome Tall Medallion Holder
BB501107G	Gold Tall Medallion Holder
BB501108B	Dark Nickel Extra Tall Medallion Holder
BB501108C	Chrome Extra Tall Medallion Holder
BB501108G	Gold Extra Tall Medallion Holder



OVAL HORIZONTAL MEDALLION ASSEMBLIES

Part Number	Description
BB501110B	Dark Nickel Short Medallion Holder
BB501110C	Chrome Short Medallion Holder
BB501110G	Gold Short Medallion Holder
BB501112B	Dark Nickel Tall Medallion Holder
BB501112C	Chrome Tall Medallion Holder
BB501112G	Gold Tall Medallion Holder
BB501113B	Dark Nickel Extra Tall Medallion Holder
BB501113C	Chrome Extra Tall Medallion Holder
BB501113G	Gold Extra Tall Medallion Holder



ROUND MEDALLION ASSEMBLIES

Part Number	Description
BB501101C	Chrome Medallion Holder with Angled Support
BB501101G	Gold Medallion Holder with Angled Support
BB501125B	Dark Nickel Short Medallion Holder
BB501125C	Chrome Short Medallion Holder
BB501125G	Gold Short Medallion Holder
BB501130B	Dark Nickel Tall Medallion Holder
BB501130C	Chrome Tall Medallion Holder
BB501130G	Gold Tall Medallion Holder
BB501131B	Dark Nickel Extra Tall Medallion Holder
BB501131C	Chrome Extra Tall Medallion Holder
BB501131G	Gold Extra Tall Medallion Holder



ROUND MEDALLION HOLDERS

3 WAY ROUND MEDALLION HOLDER

Part Number	Description
BB501200B	Dark Nickel Medallion Holder Assembly
BB501200C	Chrome Medallion Holder Assembly
BB501200G	Gold Medallion Holder Assembly

4 WAY ROUND MEDALLION HOLDER

Part Number	Description
BB501220B	Dark Nickel Medallion Holder Assembly
BB501220C	Chrome Medallion Holder Assembly
BB201220G	Gold Medallion Holder Assembly

FACE MOUNT ROUND MEDALLION HOLDER

Part Number	Description
BB501170	Chrome Round Medallion Holder with Screw for Face Mount Applications

FAUCET MOUNT ROUND MEDALLION HOLDER

Part Number	Description
BB501320C	Chrome Round Faucet Mount Medallion Holder

3" DIA. TOWER CAP WITH MEDALLION - 1 SIDE

Part Number	Description
BB103440-BR	Brass Tower Cap Medallion Holder-Holds One 82mm Diameter Medallion
BB103440-C	Chrome Tower Cap Medallion Holder-Holds One 82mm Diameter Medallion

3" DIA. TOWER CAP WITH MEDALLION - 2 SIDE

Part Number	Description
BB103442-BR	Brass Tower Cap Medallion Holder-Holds Two 82mm Diameter Medallions
BB103442-C	Chrome Tower Cap Medallion Holder-Holds Two 82mm Diameter Medallions

3" DIA. CHROME TOWER CAP WITH LIT MEDALLION HOLDER

Part Number	Description
BB103470-C	Chrome Tower Cap Lit Medallion Holder - Holds Two 80mm Diameter Medallions

CBS medallion holders are available in the following finishes:



Chrome

Dark Nickel

Gold

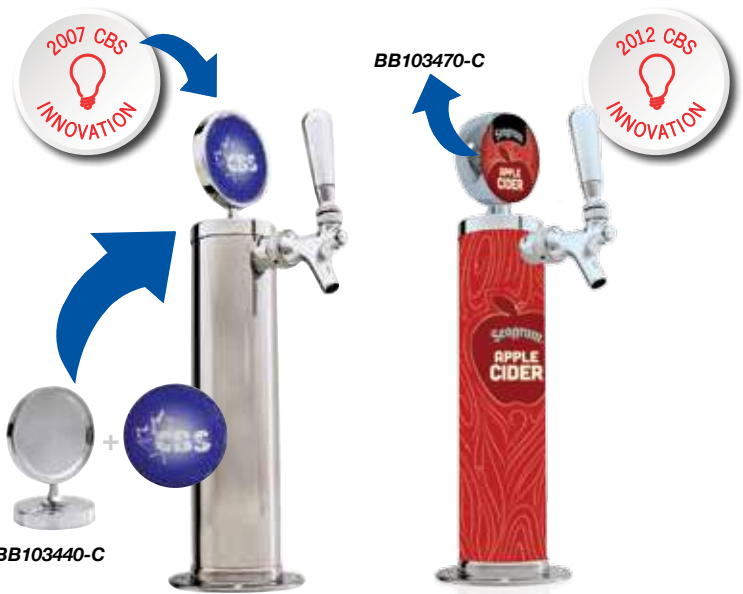

★ MEDALLIONS & TAP HANDLES NOT INCLUDED



LIT MEDALLION HOLDERS



BB502181PP



BB502183PP



BB502186PP

★ MEDALLIONS NOT INCLUDED



BB501999



BB502191-PP



BB502191-PP



80MM ROUND PLUG & PLAY LED LIT MEDALLION HOLDERS

Part Number	Description
BB502181PP	Single Chrome Plug & Play LED Lit Medallion Holder
BB502183PP	Double Chrome Plug & Play LED Lit Medallion Holder
BB502186PP	Triple Chrome Plug & Play LED Lit Medallion Holder

LED LIGHT STRIP

Part Number	Description
BB502150	LED Light Strip for VS Medallion Holders

TRANSFORMER FOR LIT MEDALLION HOLDERS

Part Number	Description
BB501999	12V-5W-.1A LED TRANSFORMER - 115V

PLUG & PLAY ELECTRICAL CONNECTION SUPPORT



Part Number	Description
BB502191-PP	Plug & Play Chrome Female Connector - Includes Conical Support w/Set Screw, Wiring and Wiring Connectors

PLUG & PLAY LIT MEDALLIONS

CBS Lights it up with the innovative Plug and Play Lit Medallion holder from Vin Service. Changing the brand logo on a medallion holder has never been easier! Just undo the allen screw at the base of the holder and remove the entire LED light assembly, medallion and all.

VS GLYCOL POWER PACKS

GLYCOL POWER PACKS - AIR COOLED

Part Number	Description
BB989950	VS 1/6 HP Flat
	<ul style="list-style-type: none"> 950 BTU's Digital Thermostat 115V/60HZ - 15 Amp Circuit 16 1/4" x 13 1/4" x 16" 3.5 Gallon Bath Vertical Pump
BB989955	VS 1/3 HP Super Flat
	<ul style="list-style-type: none"> 2800 BTU's Digital Thermostat 115V/60HZ - 15 Amp Circuit 23 3/4" x 15 1/2" x 15 3/4" 4.5 Gallon Bath Vertical Pump
BB989958	VS 1/3 HP Super Flat Ultra
	<ul style="list-style-type: none"> 2800 BTU's Digital Thermostat 115V/60HZ - 15 Amp Circuit 25" x 17" x 17" 4.5 Gallon Bath Rotary Vane Pump & Motor Dumper Coupling

Description	
VS 1/3 HP Glycol Power Packs	
<ul style="list-style-type: none"> 2900 BTU's Digital Thermostat 115V/60HZ 13.2 Gallon Bath Rotary Vane Pump & Motor Dumper Coupling 	 <p>BB989960</p>

Part Number	Part Number
BB989960	BB989963
<ul style="list-style-type: none"> One Pump & Motor 17 5/8" x 27 3/8" x 23 5/8" 15 Amp Circuit 	<ul style="list-style-type: none"> Two Pumps & Motors 23 5/8" x 27 3/8" x 23 5/8" 20 Amp Circuit

Description	
VS 1/2 HP Glycol Power Packs	
<ul style="list-style-type: none"> 4100 BTU's Digital Thermostat 115V/60HZ 13.2 Gallon Bath Rotary Vane Pump & Motor Dumper Coupling 	 <p>BB989975</p>

Part Number	Part Number
BB989971	BB989975
<ul style="list-style-type: none"> One Pump & Motor 17 5/8" x 27 3/8" x 23 5/8" 20 Amp Circuit 	<ul style="list-style-type: none"> Two Pumps & Motors 23 5/8" x 27 3/8" x 23 5/8" 25 Amp Circuit



Description	
VS 3/4 HP Glycol Power Packs	
<ul style="list-style-type: none"> 5200 BTU's Digital Thermostat 220V/60HZ 13.2 Gallon Bath Rotary Vane Pump & Motor Dumper Coupling 	 <p>BB989981</p>



Part Number	Part Number
BB989981	BB989985
<ul style="list-style-type: none"> Two Pumps & Motors 23 5/8" x 27 3/8" x 23 5/8" 25 Amp Circuit 	<ul style="list-style-type: none"> Three Pumps & Motors 29 5/8" x 27 3/8" x 23 5/8" 30 Amp Circuit



VS GPP REPLACEMENT PARTS



Part Number	Description
BB996041	Digital Thermostat for VS Glycol Power Packs (GD/FC/CT)
BB996020	Pump Assembly For Flat Glycol Power Pack
BB996024	Pump Assembly For Super Flat Glycol Power Pack



Part Number	Description
BB991050	1/3 HP Glycol Power Pack
	<ul style="list-style-type: none"> 2560 BTU's Digital Thermostat 115V/60HZ - 15 Amp Circuit 20" x 16 1/2" x 20" 4.5 Gallon Bath Vertical Pump Weight : 70 lbs 

Description	
1/2 HP Glycol Power Packs	
<ul style="list-style-type: none"> 3282 BTU's Digital Thermostat 115V/60HZ 17 Gallon Bath Rotary Vane Pump & Motor Dumper Coupling  	
Part Number	Part Number
BB991060	BB991065
<ul style="list-style-type: none"> One Pump & Motor 20 1/2" x 27 1/2" x 23" 15 Amp Circuit Weight: 115 lbs 	<ul style="list-style-type: none"> Two Pumps & Motors 26 1/2" x 27 1/2" x 23" 20 Amp Circuit Weight : 125 lbs

Description	
1/2 HP Glycol Power Packs	
<ul style="list-style-type: none"> 4080 BTU's Digital Thermostat 115V/60HZ 17 Gallon Bath Rotary Vane Pump & Motor Dumper Coupling  	
Part Number	Part Number
BB991070	BB991075
<ul style="list-style-type: none"> One Pump & Motor 20 1/2" x 27 1/2" x 23" 20 Amp Circuit Weight: 135 lbs 	<ul style="list-style-type: none"> Two Pumps & Motors 26 1/2" x 27 1/2" x 23" 25 Amp Circuit Weight : 145 lbs

Description	
3/4 HP Glycol Power Packs	
<ul style="list-style-type: none"> 6138 BTU's Digital Thermostat 115V/60HZ 17 Gallon Bath Rotary Vane Pump & Motor Dumper Coupling  	
Part Number	Part Number
BB991085	BB991090
<ul style="list-style-type: none"> Two Pumps & Motors 26 1/2" x 27 1/2" x 23" 25 Amp Circuit Weight : 145 lbs 	<ul style="list-style-type: none"> Three Pumps & Motors 26 1/2" x 27 1/2" x 29" 30 Amp Circuit Weight : 155 lbs



GPP REPLACEMENT PARTS

Part Number	Description
MP551740	1/3 HP Motor - 1725 RPM
MP000448	Dumper Coupling Kit
MP000583	49 GPH Brass Rotary Vane Pump
MP000585	75 GPH Brass Rotary Vane Pump
BB998859	Motor & 49 GPH Pump Assembly
BB998860	Motor & 75 GPH Pump Assembly

GLYCOL POWER PACKS: SYSTEM INSTALLATION

100% PROPYLENE GLYCOL USP

Part Number	Description
BB990099	100% Propylene Glycol USP - 4 Litre Jug / 1 Gallon
BB990102	100% Propylene Glycol USP - 18.9 Litre / 5 Gallons



BB990099



BB990102

TAPES

Part Number	Description
MP100700	Insulation Tape - 2" x 30'
MP100704	Insulation Tape - 2" x 48'
MP100737	Insulation Tape - 7" x 48'
MP100810	Vinyl Electrical Tape - 2" Wide x 60'
MP100820	Vinyl Electrical Tape - 2" Wide - 1 Sleeve (4 Rolls)
MP100825	Vinyl Electrical Tape - 2" Wide - 1 Case (80 Rolls)



MP100820



MP100810



MP100737



MP100700

INSULATION

Part Number	I.D	Wall Thickness
BT000010	5/8"	3/8"
BT000012	3/4"	3/8"
BT000018	1 1/8"	3/8"
BT000038	1 3/8"	3/8"
BT000058	1 5/8"	3/8"
BT000070	2 1/8"	3/8"
BT000090	3/4"	1/2"
BT000118	1 1/8"	1/2"
BT000138	1 3/8"	1/2"
BT000158	1 5/8"	1/2"
BT000178	1 7/8"	1/2"
BT000218	2 1/8"	1/2"
BT007078	7/8"	3/4"
BT007118	1 1/8"	3/4"
BT007138	1 3/8"	3/4"
BT007158	1 5/8"	3/4"
BT007178	1 7/8"	3/4"
BT007218	2 1/8"	3/4"



BT007118

Glycol Tester
use this device to
get an accurate
reading of the
glycol/water ratio
in the Power Pack
bath.

BB990300

COLD KIT COMPONENTS

Part Number	Description
BB431910	3/8" OD ACR Copper Cooling Loop
BB431913	SS Cooling Loop
SF600375	SS 3/8" OD Tube Compression x 3/8" Barb
BB700218	Square Brass Cold Block - Fits 7/8" Shanks



BB431910

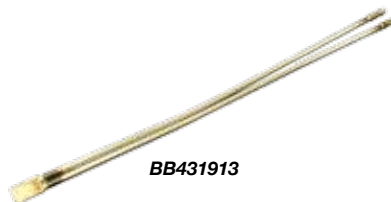

BB431913



SF600375



BB700218

BARRIER TUBING

Part Number	Description	Color	Length
BT143650	3/16" ID x 5/16" OD Barrier Tubing	Natural	500'
BT143900	1/4" ID x 3/8" OD Barrier Tubing	Natural	500'
BT384900	5/16" ID x 7/16" OD Barrier Tubing	Natural	500'
BT385100	3/8" ID x 1/2" OD Barrier Tubing	Natural	500'



BT385100



BT385818



BT385809

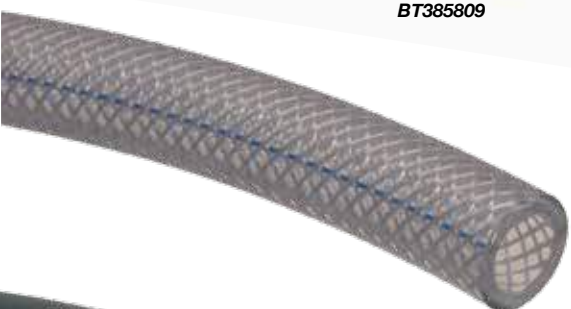

BT385800



BT601000



BT144600

ULTRA BARRIER TUBING

Part Number	Description	Color	Length
BT382187	3/16" ID x 7/16" OD PVC/BPA Free Tubing	Clear	100'
BT382250	1/4" ID x 1/2" OD PVC/BPA Free Tubing	Clear	100'
BT382375	3/8" ID x 5/8" OD PVC/BPA Free Tubing	Clear	100'
BT387312	5/16" ID x 9/16" OD PVC/BPA Free Tubing	Clear/Red Line	100'

VINYL TUBING

Part Number	Description	Color	Length
BT385175	1/8" I.D. x 3/16" OD EVA Tubing	Clear	2000'
BT385187	3/16" ID x 7/16" OD Vinyl Tubing	Clear	100'
BT385804	5/16" ID x 9/16" OD Vinyl Tubing	Clear	100'
BT385809	3/8" ID x 5/8" OD Vinyl Tubing	Clear	100'
BT385818	5/16" ID x 9/16" OD Vinyl Tubing	Red	100'
BT385825	1/4" ID x 1/2" OD Vinyl Tubing	Clear	100'

PVC BRAIDED HOSE

Part Number	Description	Color	Length
BT144500	1/4" ID x 1/2" OD PVC Braid	Clear	100'
BT385800	5/16" ID x 9/16" OD PVC Braid	Clear	100'
BT385807	3/8" ID x 5/8" OD PVC Braid	Clear	100'
BT500650	1/2" ID x 3/4" OD PVC Braid	Clear	100'
BT500675	3/4" ID x 1" OD PVC Braid	Clear	100'

VINYL DRAIN TUBING

Part Number	Description	Color	Length
BT385815	5/16" ID x 7/16" OD Vinyl Drain Tubing	Clear	100'
BT600740	1/2" ID x 3/4" OD Vinyl Drain Tubing	Grey	100'
BT600750	3/4" ID x 1" OD Vinyl Drain Tubing	Grey	100'
BT601000	1" ID x 1 1/4" OD Vinyl Drain Tubing	Grey	100'

POLYETHYLENE TUBING

Part Number	Description	Color	Length
BT143800	1/4" ID x 3/8" OD Poly Tubing	Natural	500'
BT385000	3/8" ID x 1/2" OD Poly Tubing	Natural	500'

POLY BRAIDED HOSE

Part Number	Description	Color	Length
BT144600	.265" (1/4") ID x .457" OD Poly Braid	White	500'
BT144700	.265" (1/4") ID x .457" OD Poly Braid	Black	500'
BT386350	.375" (3/8") ID x .593" OD Poly Braid	White	300'
BT386375	.375" (3/8") ID x .593" OD Poly Braid	Black	300'

TUBING: TRUNKLINE

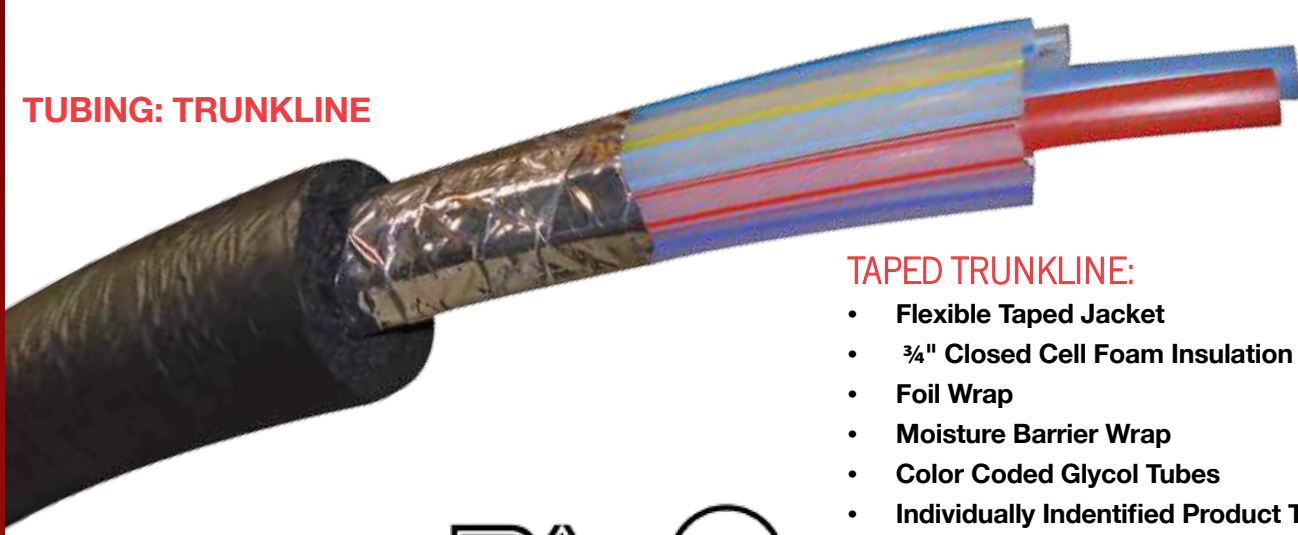

TAPED TRUNKLINE:

- Flexible Taped Jacket
- 3/4" Closed Cell Foam Insulation
- Foil Wrap
- Moisture Barrier Wrap
- Color Coded Glycol Tubes
- Individually Identified Product Tubes
- Cabled For Maximum Flexibility

* Tubing lengths can be cut to order and shipped the same day



1/4" ID TRUNKLINE - .30 LBS OF RESTRICTION PER FOOT



BT040125

Part Number	Cabled	Tubing	Product Tubes	ID	Glycol Tubes	ID	Bundle OD
BT040125	X	Duoflex	2	1/4"	2	3/8"	2 3/4"
BT060125	X	Duoflex	4	1/4"	2	3/8"	2 3/4"

5/16" ID TRUNKLINE - .10 LBS OF RESTRICTION PER FOOT



BT042257

Part Number	Cabled	Tubing	Product Tubes	ID	Glycol Tubes	ID	Bundle OD
BT042257	X	Hi-Gloss	2	5/16"	2	3/8"	2 3/4"
BT064257	X	Hi-Gloss	4	5/16"	2	3/8"	2 3/4"
BT086257	X	Hi-Gloss	6	5/16"	2	3/8"	3"
BT108257	X	Hi-Gloss	8	5/16"	2	3/8"	3 1/4"
BT108259	X	Duoflex	8	5/16"	2	3/8"	3 1/4"
BT1410457	✓	Hi-Gloss	10	5/16"	4	3/8"	3 1/2"
BT1410459	✓	Duoflex	10	5/16"	4	3/8"	3 1/2"
BT1612457	✓	Hi-Gloss	12	5/16"	4	3/8"	3 3/4"
BT1612459	✓	Duoflex	12	5/16"	4	3/8"	3 3/4"
BT1814457	✓	Hi-Gloss	14	5/16"	4	3/8"	4"
BT1814459	✓	Duoflex	14	5/16"	4	3/8"	4"
BT2016457	✓	Hi-Gloss	16	5/16"	4	3/8"	4 1/4"
BT2016459	✓	Duoflex	16	5/16"	4	3/8"	4 1/4"

3/8" ID TRUNKLINE - .06 LBS OF RESTRICTION PER FOOT



BT042287

Part Number	Cabled	Tubing	Product Tubes	ID	Glycol Tubes	ID	Bundle OD
BT042287	X	Hi-Gloss	2	3/8"	2	3/8"	2 3/4"
BT064287	X	Hi-Gloss	4	3/8"	2	3/8"	2 3/4"
BT086287	X	Hi-Gloss	6	3/8"	2	3/8"	3"
BT108287	X	Hi-Gloss	8	3/8"	2	3/8"	3 1/4"
BT1410487	✓	Hi-Gloss	10	3/8"	4	3/8"	3 1/2"
BT1410489	✓	Duoflex	10	3/8"	4	3/8"	3 1/2"
BT1612487	✓	Hi-Gloss	12	3/8"	4	3/8"	3 3/4"
BT1612489	✓	Duoflex	12	3/8"	4	3/8"	3 3/4"
BT1814487	✓	Hi-Gloss	14	3/8"	4	3/8"	4"
BT2016487	✓	Hi-Gloss	16	3/8"	4	3/8"	4 1/4"

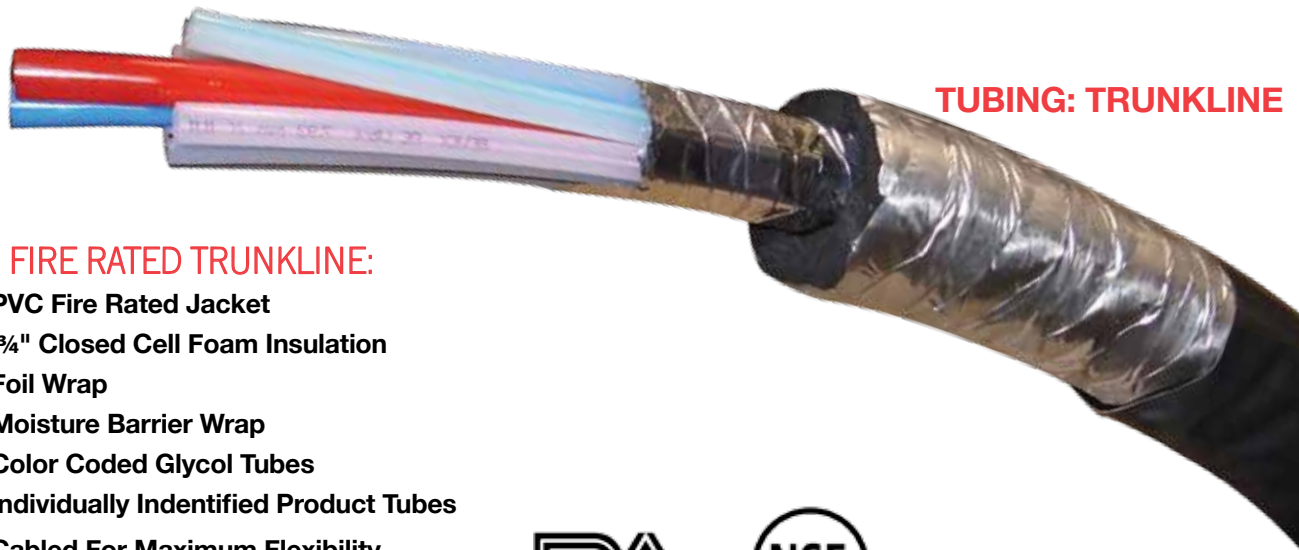

PVC FIRE RATED TRUNKLINE:

- PVC Fire Rated Jacket
- 3/4" Closed Cell Foam Insulation
- Foil Wrap
- Moisture Barrier Wrap
- Color Coded Glycol Tubes
- Individually Identified Product Tubes
- Cabled For Maximum Flexibility



* Tubing lengths can be cut to order and shipped the same day

5/16" ID TRUNKLINE - .10 LBS OF RESTRICTION PER FOOT

Part Number	Cabled	Tubing	Product Tubes	ID	Glycol Tubes	ID	Bundle OD
BT042260	X	Hi-Gloss	2	5/16"	2	3/8"	2 3/4"
BT064260	X	Hi-Gloss	4	5/16"	2	3/8"	2 3/4"
BT086260	X	Hi-Gloss	6	5/16"	2	3/8"	3"
BT108260	X	Hi-Gloss	8	5/16"	2	3/8"	3 1/4"
BT1210260	✓	Hi-Gloss	10	5/16"	2	1/2"	3 1/2"
BT1410460	✓	Hi-Gloss	10	5/16"	4	3/8"	3 1/2"
BT1612460	✓	Hi-Gloss	12	5/16"	4	3/8"	3 3/4"
BT1814460	✓	Hi-Gloss	14	5/16"	4	3/8"	4"



BT042260

3/8" ID TRUNKLINE - .06 LBS OF RESTRICTION PER FOOT

Part Number	Cabled	Tubing	Product Tubes	ID	Glycol Tubes	ID	Bundle OD
BT042290	X	Hi-Gloss	2	3/8"	2	3/8"	2 3/4"
BT064290	X	Hi-Gloss	4	3/8"	2	3/8"	2 3/4"
BT086290	X	Hi-Gloss	6	3/8"	2	3/8"	3"
BT108290	X	Hi-Gloss	8	3/8"	2	3/8"	3 1/4"
BT1210290	✓	Hi-Gloss	10	3/8"	2	1/2"	3 1/2"
BT1410490	✓	Hi-Gloss	10	3/8"	4	3/8"	3 1/2"
BT1612490	✓	Hi-Gloss	12	3/8"	4	3/8"	3 3/4"
BT1814490	✓	Hi-Gloss	14	3/8"	4	3/8"	4"



BT042290

GLYCOL POWER PACK CONNECTOR

USE TO CONNECT GLYCOL POWER PACK TO TRUNK LINE

Part Number	Description
BT020200	2 Glycol Tubes
BT040400	4 Glycol Tubes

CONNECTOR INCLUDES:

- Flexible Taped Jacket
- 3/4" Closed Cell Foam Insulation
- Foil Wrap
- Moisture Barrier Wrap
- 3/8" ID Color Coded Glycol Tubes



BT020200



BT040400

FLASH COOLERS

FLASH COOLERS – AIR COOLED

Part Number	Description
BB900205	Vin Service "Flat" Flash Cooler w/2-SS Product Lines (9m +8m)-115V-25L/Hour
BB900214	Vin Service HE60 Flash Cooler w/4-SS Product Lines (6m,6m,10m,7m)-115V-60L/Hour
BB900219	Vin Service HE90V Flash Cooler w/4-SS Product Lines (8m,9m,14m,12m)-115V-90L/Hour
BB900222	Vin Service HE120V Flash Cooler w/4-SS Product Lines (22m,21m,19m,17m)-115V-120L/Hour
BB900224	Vin Service HE120V Flash Cooler w/6-SS Product Lines (21m, 20m, 17m, 14m, 13m, 13m) 115V-120L/Hour

*See page 59 for Superseal fittings (recommended for SS tubing)

Install a Flash Cooler to cool beer, wine, cider, water, juice, soda, liquor or coffee



BB900205



BB900214



BB900219



BB900222



BB900224

FLASH COOLER REPLACEMENT PARTS

Part Number	Description
BB996029	Pump Assembly for VS Flat Flash Cooler
BB996033	Pump Assembly for VS HE60 Flash Cooler
BB996037	Pump Assembly for VS HE90 & HE120 Flash Coolers
BB996041	Digital Thermostat for VS Flash Coolers and Glycol Power Packs
BB996045	Ice Bank Control for VS Flash Coolers
BB996075	Probe for VS Digital Thermostat - BB996041
BB996079	Probe for VS HE60, HE90 and HE120 Flash Coolers



BB996045



BB996041



BB996029



BB996037

SS COIL COOLER

Part Number	Description
CL105200	8qt SS Coil Cooler with a 50' Coil and 2 Cooler Coupling Shanks. This unit is great for setting up a portable draught dispensing system for tastings or temporary dispensing. Add a Clamp-On Tower, Regulator, Coupler, some tubing and a Keg and you're ready to go! No Electricity required.



CL105200

CLAMP-ON TOWERS



BB103191ACC

★ TAPS SOLD SEPARATELY

Part Number	Description
BB103121CC	3" Dia. 1 Tap Polished SS Tower with Chrome Clamp-On Bracket & Drip Tray
BB103122CC	3" Dia. 2 Tap Polished SS Tower with Chrome Clamp-On Bracket & Drip Tray
BB103126CC	3" Dia. 3 Tap Polished SS Tower with Chrome Clamp-On Bracket & Drip Tray
BB103118SSCC	3" Dia. 1 Tap (304SS) Polished SS Tower with Chrome Clamp-On Bracket & Drip Tray
BB103119SSCC	3" Dia. 2 Tap (304SS) Polished SS Tower with Chrome Clamp-On Bracket & Drip Tray
BB103171ACC	1 Tap Chrome Mongoose with US Tap, Chrome Clamp-On Bracket & Drip Tray
BB103173ACC	2 Tap Chrome Mongoose with US Taps, Chrome Clamp-On Bracket & Drip Tray
BB103191ACC	1 Tap Chrome Sexy with US Tap, Chrome Clamp-On Bracket & Drip Tray
BB103193ACC	2 Tap Chrome Sexy with US Taps, Chrome Clamp-On Bracket & Drip Tray

★ TAP HANDLES NOT INCLUDED



BB103171ACC



BB103121CC



BB103122CC

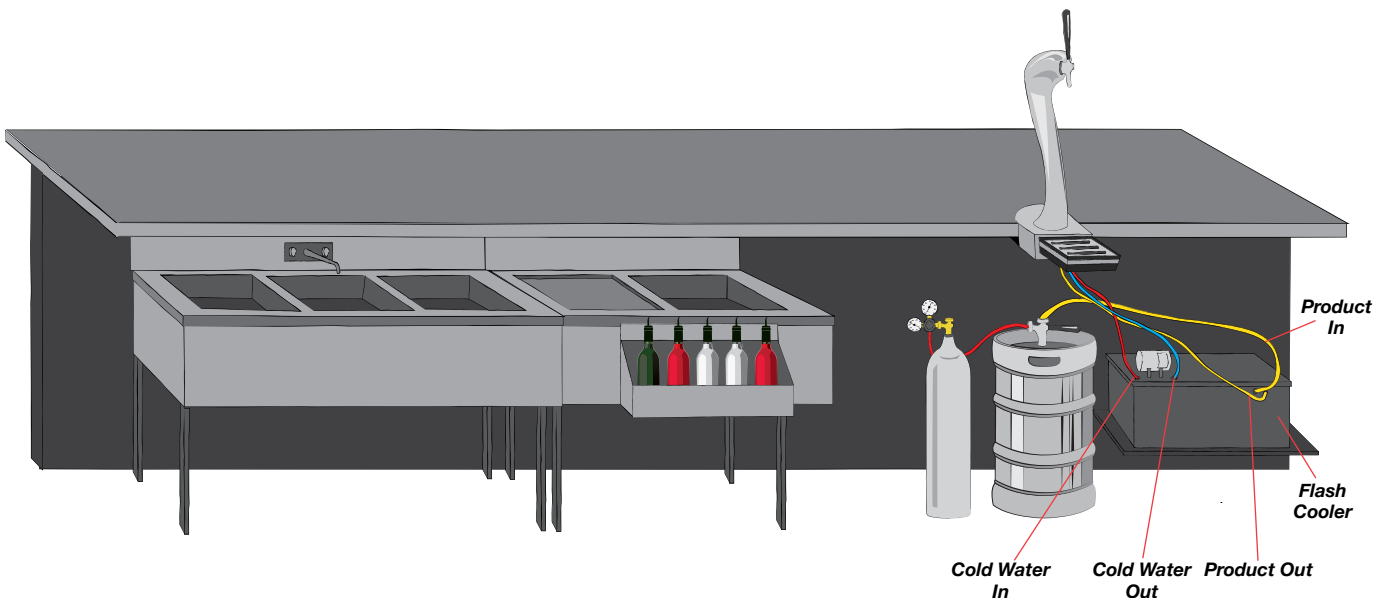

TUBE AND HOSE FITTINGS



SF143325-X



SF147725-X



SF312312-X



SF147738-X



SF380380



BB101504



SF147251



MP551837



BB101495



BB101538



BB101503



BB101501

TEES – STANDARD

Part Number	Description
SF143325	SS 1/4" x 1/4" x 1/4" Barb Tee
SF143200	Brass 1/4" x 1/4" x 1/4" Barb Tee
SF147249N	Nylon 1/4" x 1/4" x 1/4" Barb Tee
SF383335	SS 3/8" x 3/8" x 3/8" Barb Tee
SF383200	Brass 3/8" x 3/8" x 3/8" Barb Tee
SF147252N	Nylon 3/8" x 3/8" x 3/8" Barb Tee
SF383385	SS 1/4" x 1/4" x 3/8" Barb Tee
SF383389	SS 3/8" x 3/8" x 1/4" Barb Tee
SF500555	SS 1/2" x 1/2" x 1/2" Barb Tee
SF500558	SS 1/2" x 1/2" x 1/4" Barb Tee

TEES – 304SS

Part Number	Description
SF143325-X	304SS 1/4" x 1/4" x 1/4" Barb Tee
SF300312-X	304SS 5/16" x 5/16" x 5/16" Barb Tee
SF383335-X	304SS 3/8" x 3/8" x 3/8" Barb Tee
SF500555-X	304SS 1/2" x 1/2" x 1/2" Barb Tee
SF383385-X	304SS 1/4" x 1/4" x 3/8" Barb Tee
SF383389-X	304SS 3/8" x 3/8" x 1/4" Barb Tee

SPLICERS – STANDARD

Part Number	Description
SF087625	SS 1/8" x 1/8" Barb Splicer
SF147725	SS 1/4" x 1/4" Barb Splicer
SF147722	Brass 1/4" x 1/4" Barb Splicer
SF147248	Plastic 1/4" x 1/4" Barb Splicer
SF387735	SS 3/8" x 3/8" Barb Splicer
SF387733	Brass 3/8" x 3/8" Barb Splicer
SF147253	Plastic 3/8" x 3/8" Barb Splicer
SF500750	SS 1/2" x 1/2" Barb Splicer

SPLICERS – 304SS

Part Number	Description
SF147725-X	304SS 1/4" x 1/4" Barb Splicer
SF312312-X	304SS 5/16" x 5/16" Barb Splicer
SF387735-X	304SS 3/8" x 3/8" Barb Splicer
SF500750-X	304SS 1/2" x 1/2" Barb Splicer

REDUCERS – STANDARD

Part Number	Description
SF087725	SS 1/4" x 1/8" Barb Reducer
SF147500	SS 1/2" x 1/4" Barb Reducer
SF147738	SS 3/8" x 1/4" Barb Reducer
SF387750	SS 1/2" x 3/8" Barb Reducer

REDUCERS – 304SS

Part Number	Description
SF312250-X	304SS 5/16" x 1/4" Barb Reducer
SF147738-X	304SS 3/8" x 1/4" Barb Reducer
SF387312-X	304SS 3/8" x 5/16" Barb Reducer
SF387750-X	304SS 1/2" x 3/8" Barb Reducer

90° ELBOWS

Part Number	Description
SF250250	SS 1/4" x 1/4" Barb Elbow
SF300300	SS 5/16" x 5/16" Barb Elbow
SF300300-X	304SS 5/16" x 5/16" Barb Elbow
SF380380	SS 3/8" x 3/8" Barb Elbow
SF380380-X	304SS 3/8" x 3/8" Barb Elbow

BEER SWITCH

Part Number	Description
BB101501	Beer Switch: 3/8" Bore

PLUGS

Part Number	Description
SF147250	SS 1/4" Barb Plug
SF387370	SS 3/8" Barb Plug
SF147251	Plastic 1/4" x 3/8" Plug - Fits both 1/4" and 3/8" Tubing

SHUT-OFFS

Part Number	Description
BB101495	Beer Shut-Off: 3/8" Bore
BB101496-SS	304SS Shut-Off: 3/8" Bore
MP551825	Plastic Shut-Off: 1/4" x 1/4"
MP551830	Plastic Shut-Off: 1/4" x 3/8"
MP551837	Plastic Shut-Off: 3/8" x 3/8"

EURO TAILPIECES

Part Number	Description
BB101538	1/2" BSP x 3/16" Straight Tailpiece
BB101539	5/8" BSP x 3/16" Straight Tailpiece
BB101541	5/8" BSP x 3/16" Bent Tailpiece

BEER "Y" FITTING

Part Number	Description
BB101503	Beer "Y": 3/8" Bore

NUTS & WASHERS

Part Number	Description
BB101504	Hexnut
BB101536-SS	SS Hexnut
BB101548	Euro Hexnut
BB101505	Wing Nut
BB101030	Hexnut Washer

TUBE AND HOSE FITTINGS



SF792300



BB101545



BB101529



BB101530



BB101531



BB101502



BB101030



BB101533



BB101510



BB101510SS



SF792265



OC157



OC99-04

U-BENDS – 304SS

Part Number	Description
SF792290-X	304SS 5/16" x 5/16" Barb U-Bend with 5/16" Stem
SF792300-XLG	304SS 3/8" x 3/8" Barb U-Bend
SF792300-XSM	304SS 3/8" x 3/8" Barb U-Bend-Small Radius
SF792400-X	304SS 1/2" x 1/2" Barb U-Bend
SF792750-X	304SS 3/8" x 3/8" Barb U-Bend with 3/8" Stem

U-BENDS – STANDARD

Part Number	Description
SF792200	SS 1/4" x 1/4" Barb U-Bend
SF792300	SS 3/8" x 3/8" Barb U-Bend
SF792400	SS 1/2" x 1/2" Barb U-Bend
SF792265	SS 1/4" x 1/4" Barb U-Bend with a 1/4" Barb Stem
SF792375	SS 3/8" x 3/8" Barb U-Bend with a 1/4" Barb Stem
SF792750	SS 3/8" x 3/8" Barb U-Bend with a 3/8" Barb Stem
SF792755	SS 1/2" x 1/2" Barb U-Bend with a 3/8" Barb Stem

WALL BRACKETS

Part Number	Description
BB101545	304SS Wall Bracket - 3/8" Bore
BB101529	Wall Bracket - 3/8" Bore
BB101530	304SS Wall Bracket with 3/8" Barb Elbow
BB101531	304SS Wall Bracket with Straight 3/8" Barb
BB101502	Wall Bracket "Y" - 3/8" Bore

90° BEER TAILPIECES

Part Number	Description
BB101511	Nickel Plated 3/16" 90° Tailpiece
BB101512	Nickel Plated 1/4" 90° Tailpiece
BB101532	304SS 1/4" 90° Tailpiece
BB101533	304SS 5/16" 90° Tailpiece
BB101534	304SS 3/8" 90° Tailpiece
BB101541	Nickel Plated 5/8" x 3/16" 90° Euro Tailpiece

STAINLESS STEEL GEAR CLAMPS

Part Number	Description
OC99-04	#4 SS Gear Clamp - 5/8" max. diameter
OC99-05	#5 SS Gear Clamp - 3/4" max. diameter
OC99-06	#6 SS Gear Clamp - 7/8" max. diameter

STAINLESS STEEL STEPLESS CLAMPS

Part Number	Size	Part Number	Size
OC070	7.0mm	OC157	15.7mm
OC087	8.7mm	OC162	16.2mm
OC095	9.5mm	OC170	17.0mm
OC105	10.5mm	OC185	18.5mm
OC113	11.3mm	OC198	19.8mm
OC118	11.8mm	OC210	21.0mm
OC123	12.3mm	OC226	22.6mm
OC133	13.3mm	OC241	24.1mm
OC140	14.0mm	OC271	27.1mm
OC145	14.5mm		

TAILPIECES

Part Number	Description
BB101506	Nickel Plated 3/16" Tailpiece
BB101506SS	304SS 3/16" Tailpiece
BB101507	Nickel Plated 1/4" Tailpiece
BB101507SS	304SS 1/4" Tailpiece
BB101510	Nickel Plated 5/16" Tailpiece
BB101510SS	304SS 5/16" Tailpiece
BB101508	Nickel Plated 3/8" Tailpiece
BB101508SS	304SS 3/8" Tailpiece
BB101509	Nickel Plated 1/2" Tailpiece
BB101509SS	304SS 1/2" Tailpiece

JG PUSH-IN FITTINGS

MALE CONNECTORS-NPT

Part Number	Description
QD100900	3/16" OD Tube x 1/8" NPT F (M)
QD100910	1/4" OD Tube x 1/8" NPT F (M)
QD100912	3/8" OD Tube x 1/8" NPT F (M)
QD100920	1/4" OD Tube x 3/8" NPT F (M)
QD100924	5/16" OD Tube x 1/4" NPT F (M)
QD100925	3/8" OD Tube x 1/4" NPT F (M)
QD100930	3/8" OD Tube x 3/8" NPT F (M)
QD100935	1/2" OD Tube x 3/8" NPT F (M)
QD100940	1/2" OD Tube x 1/2" NPT F (M)



FEMALE CONNECTORS - BSP THREAD

Part Number	Description
QD100459	3/8" OD Tube x 3/8" BSP
QD100460	1/2" OD Tube x 3/8" BSP
QD100631	3/8" OD Tube x 5/8" BSP
QD100632	1/2" OD Tube x 5/8" BSP
QD100633	3/8" OD Tube x 1/2" BSP



UNION ELBOWS

Part Number	Description
QD200200	1/4" OD Tube x 1/4" OD Tube
QD200205	3/8" OD Tube x 3/8" OD Tube
QD200210	1/2" OD Tube x 1/2" OD Tube



UNION CONNECTORS

Part Number	Description
QD100115	1/4" OD Tube x 1/4" OD Tube
QD100311	5/16" OD Tube x 5/16" OD Tube
QD100312	3/8" OD Tube x 3/8" OD Tube
QD100316	1/2" OD Tube x 1/2" OD Tube



REDUCING UNION CONNECTORS

Part Number	Description
QD100310	5/16" OD Tube x 1/4" OD Tube
QD100314	3/8" OD Tube x 5/16" OD Tube
QD100324	3/8" OD Tube x 3/16" OD Tube
QD100325	3/8" OD Tube x 1/4" OD Tube
QD100350	1/2" OD Tube x 3/8" OD Tube

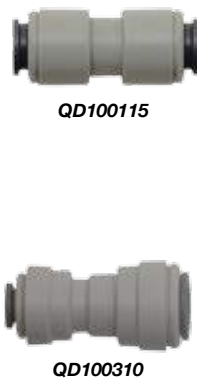

FLARED MALE CONNECTORS

Part Number	Description
QD100970	3/8" OD Tube x 3/8" MFL

FEMALE FLARE CONNECTORS

Part Number	Description
QD100449	1/4" OD Tube x 1/4" FFL
QD100450	3/8" OD Tube x 1/4" FFL
QD100451	3/8" OD Tube x 3/8" FFL

UNION TEES

Part Number	Description
QD100112	Three 1/4" OD Tubes
QD100202	Three 3/16" OD Tubes
QD100212	Three 3/8" OD Tubes
QD100216	Three 1/2" OD Tubes

REDUCING ELBOWS

Part Number	Description
QD200220	3/8" OD Tube x 1/4" OD Tube
QD200223	3/8" OD Tube x 5/16" OD Tube
QD200226	1/2" OD Tube x 3/8" OD Tube

STEM ADAPTERS

Part Number	Description
QD200570	1/4" OD Stem x 1/4" NPT F (M)
QD200573	3/8" OD Stem X 1/4" NPT F (M)
QD200575	3/8" OD Stem x 3/8" NPT F (M)

SHUT-OFF VALVES

Part Number	Description
QD100540	1/4" OD Tube x 1/4" OD Tube
QD100540-JG	1/4" OD Tube x 1/4" OD Tube
QD100550	3/8" OD Tube x 3/8" OD Tube
QD100550-JG	3/8" OD Tube x 3/8" OD Tube
QD100551	1/2" OD Tube x 1/2" OD Tube





QD100277



QD100670



QD100700



QD100715



QD200562



QD200560



QD200550



QD100375



QD100380



QD100392

REDUCING TEES

Part Number	Description
QD100277	Two 3/8" OD Tubes x Single 1/4" OD Tube
QD100280	Two 1/2" OD Tubes x Single 3/8" OD Tube

TUBE TO HOSE STEMS

Part Number	Description
QD100670	5/16" OD Stem x 3/16" Barb
QD100675	5/16" OD Stem x 1/4" Barb
QD100680	5/16" OD Stem x 5/16" Barb
QD100695	3/8" OD Stem x 1/4" Barb
QD100697	3/8" OD Stem x 5/16" Barb
QD100698	5/16" OD Stem x 3/8" Barb
QD100700	3/8" OD Stem x 3/8" Barb
QD100705	3/8" OD Stem x 1/2" Barb
QD100710	1/2" OD Stem X 3/8" Barb
QD100715	1/2" OD Stem X 1/2" Barb

REDUCERS

Part Number	Description
QD200561	3/8" OD Stem x 3/16" OD Tube Reducer
QD200562	3/8" OD Stem x 1/4" OD Tube Reducer
QD200564	3/8" OD Stem x 5/16" OD Tube Reducer
QD200567	5/16" OD Stem x 3/16" OD Tube Reducer

ENLARGER

Part Number	Description
QD200560	5/16" OD Stem x 3/8" OD Tube Enlarger

PLUGS

Part Number	Description
QD200550	1/4" OD Stem Plug
QD200555	3/8" OD Stem Plug
QD200557	1/2" OD Stem Plug

TWO-WAY DIVIDER

Part Number	Description
QD100375	3/8" OD Tube to 2 - 3/8" OD Tubes
QD100377	1/2" OD Tube to 2 - 1/2" OD Tubes

THREE-WAY DIVIDER

Part Number	Description
QD100380	1/2" OD Tube to 3 - 3/8" OD Tubes

U-BEND

Part Number	Description
QD100392	1/2" OD X 1/2" OD U-Bend

JG PUSH-IN FITTINGS

TUBE TO HOSE ELBOWS

Part Number	Description
QD100754	5/16" OD Stem x 1/4" Barb Elbow
QD100760	3/8" OD Stem x 1/4" Barb Elbow
QD100764	3/8" OD Stem x 5/16" Barb Elbow
QD100765	3/8" OD Stem x 3/8" Barb Elbow



QD100760

PLUG IN ELBOWS

Part Number	Description
QD200250	5/16" OD Stem x 5/16" OD Tube Plug In Elbow
QD200252	5/16" OD Stem x 3/8" OD Tube Plug In Elbow
QD200255	3/8" OD Stem x 1/4" OD Tube Plug In Elbow
QD200260	3/8" OD Stem x 3/8" OD Tube Plug In Elbow
QD200270	1/2" OD Stem x 1/2" OD Tube Plug In Elbow



QD200260

FIXED ELBOWS

Part Number	Description
QD200320	1/4" OD Tube x 1/8" NPT F Fixed Elbow (M)
QD200330	1/4" OD Tube x 3/8" NPT F Fixed Elbow (M)
QD200335	3/8" OD Tube x 3/8" NPT F Fixed Elbow (M)



QD200320

BULKHEAD UNIONS

Part Number	Description
QD200400	3/8" OD Tube x 1/4" OD Tube Bulkhead Union
QD200409	5/16" OD Tube x 5/16" OD Tube Bulkhead Union
QD200410	3/8" OD Tube x 3/8" OD Tube Bulkhead Union



QD200400

END STOPS

Part Number	Description
QD200500	1/4" OD Tube End Stop
QD200505	3/8" OD Tube End Stop



QD200500

LOCKING CLIPS

Part Number	Description
QD500910	1/4" OD Tube Locking Clip
QD500920	3/8" OD Tube Locking Clip
QD500930	1/2" OD Tube Locking Clip
QD500940	5/16" OD Tube Locking Clip



QD500910

CPC FITTINGS - QUICK DISCONNECT SHUT-OFFS

Part Number	Description
QD700421	1/4" ID Hose Barb Socket-Female
QD700422	3/8" ID Hose Barb Socket-Female
QD700426	1/4" ID Hose Barb Insert-Male
QD700427	3/8" ID Hose Barb Insert-Male



QD700427

QD700422



QD500980



QD700725-JG



QD500415



QD500425



QD500432



QD500403



QD501001



MP559970

COLLET COVERS

Part Number	Description
QD500980	3/8" OD Tube
QD500985	1/2" OD Tube

CHECK VALVES

Part Number	Description
QD700725	3/8" OD Tube x 3/8" OD Tube
QD700725-JG	JG 3/8" OD Tube x 3/8" OD Tube
QD700730	1/2" OD Tube x 1/2" OD Tube

SUPERSEAL FITTINGS - FOR USE WITH STAINLESS STEEL TUBING SUPERSEAL UNION CONNECTOR

Part Number	Description
QD500415	5/16" SS OD x 5/16" OD Tube
QD500437	3/8" SS OD x 3/8" OD Tube

SUPERSEAL UNION ELBOW

Part Number	Description
QD500425	5/16" SS OD x 5/16" OD Tube
QD500440	3/8" SS OD x 3/8" OD Tube

SUPERSEAL REDUCING ELBOW

Part Number	Description
QD500432	5/16" SS OD x 3/8" OD Tube
QD500435	3/8" SS OD x 5/16" OD Tube
QD500405	1/4" SS OD x 3/8" OD Tube

SUPERSEAL REDUCING UNION

Part Number	Description
QD500403	1/4" SS OD x 3/8" OD Tube
QD500417	5/16" SS OD x 3/8" OD Tube

COLLET RELEASE TOOL SET

Part Number	Description
QD501001	For use with the following Tube OD's - 3/16", 1/4", 5/16", 3/8", 1/2"

POCKET HOSE CUTTER

Part Number	Description
MP559970	Pocket Hose Cutter

WALK-IN COOLER: KEG COUPLERS

"D" SYSTEM - LEVER HANDLE

Part Number	Description
BB100990	TOF "D" System Keg Coupler
BB100992SS	TOF "D" System Keg Coupler w/ 304SS Probe
BB101007	American Beverage Sankey Keg Coupler
BB101007-SS	American Beverage Sankey Keg Coupler w/ 304SS Probe
BB101008	American Beverage Sankey Keg Coupler w/Rotating Probe
BB101015	Micro-Matic Sankey Keg Coupler
BB101016-SS	Micro-Matic Sankey Keg Coupler w/ 304SS Probe for Cider/Wine
BB100055	Perlick Sankey Keg Coupler
BB100060	Perlick Sankey Keg Coupler w/Rotating Probe



BB101008

BB100990



BB101015

"D" SYSTEM

LOW PROFILE KEG COUPLER

Part Number	Description
BB100050	Perlick Sankey-"D" System



BB100050

"S" SYSTEM - LEVER HANDLE

Part Number	Description
BB100995	TOF "S" System Keg Coupler
BB100997SS	TOF "S" System Keg Coupler w/ 304SS Probe
BB101009	American Beverage Euro Sankey w/Rotating Probe
BB101010	American Beverage Euro Sankey
BB101015-E	Micro-Matic Euro Sankey
BB101015-ESS	Micro-Matic Euro Sankey w/ 304SS Probe for Beer



BB101015-ESS



BB101015-E

"S" SYSTEM



BB101010

BRANDED ID-A-TUBE

Part Number	Description
YY098950	Branded ID-A-Tube* (10/PKG)



Organize the walk-in cooler with ID-A-Tubes from CBS. Place our custom branded ID-A-Tubes near the keg couplers for quick identification of the brand that is on tap!

WALK-IN COOLER: KEG COUPLERS

"A"



BB101002B-TS

"G"



BB101000B-TS

"U"



BB101001B-TS

"KEY KEG"



BB101004B-TS



BB101005

"M"



BB101003B-TS

EUROPEAN COUPLERS

Part Number	Description
BB101002B-TS	TOF Keg Coupler -"A" System w/304SS Probe
BB101002-M-S	Micro-Matic Keg Coupler -"A" System
BB101000B-TS	TOF Keg Coupler -"G" System w/304SS Probe
BB101000-M	Micro-Matic Keg Coupler -"G" System
BB101001B-TS	TOF Keg Coupler -"U" System w/304SS Probe
BB101001-M	Micro-Matic Keg Coupler -"U" System
BB101003B-TS	TOF Keg Coupler -"M" System w/304SS Probe
BB101003-M	Micro-Matic Keg Coupler -"M" System
BB101004B-TS	TOF Keg Coupler -"KEY KEG" System w/304SS Probe

WING HANDLED COUPLERS

Part Number	Description
BB101005	American Beverage Sankey -"D" System
BB101006	American Beverage Euro Sankey -"S" System

Probe lubricant is vital for a well-functioning beer system!



BB101707

PROBE LUBRICANT

Part Number	Description
BB101707	Keg Coupler Probe Lubricant

KEG COUPLER PROBE LUBRICANT

Probe lubricant is an often-overlooked component of a well-functioning beer system. Odorless & tasteless, it lubricates and protects sankey gaskets and can prevent costly leaks!

WALK-IN COOLER: KEG COUPLERS

REPLACEMENT PARTS FOR AMERICAN BEVERAGE COUPLERS

Item	Part Number	Description
1	BB101040	Yoke Assembly with Pin and Nut
2	BB101035	Ball Retainer
3	BB101034	Ball
4	BB101029	Probe Assembly (US)
5	BB101033	Probe Washer (US)
5	BB101033E	Probe Washer (Euro)
6	BB101025	Probe O'Ring
7	BB101036	Safety Assembly
8	BB101031	Thomas Valve
9	BB101090	Retainer for Gas Valve
10	BB101510	5/16" Hose Tailpiece
11	BB101504	Hexnut
12	BB101032	Body Washer

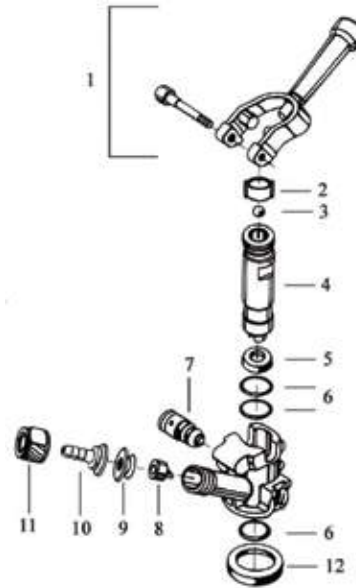

REPLACEMENT PARTS FOR MICRO-MATIC COUPLERS

Item	Part Number	Description
1	BB101015-4	Ball Retainer
2	BB101015-5	Ball
3	BB101018	Probe Washer
4	BB101015-3	Probe O'Rings
5	BB101037	Safety Assembly
6	BB101015-2	Check Valve
7	BB101015-6	5/16" Hose Tailpiece
8	BB101504	Hexnut
9	BB101017	Body Washer

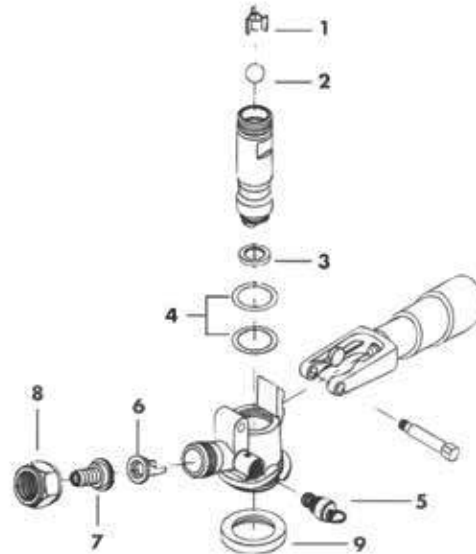

REPLACEMENT PARTS FOR PERLICK COUPLERS

Item	Part Number	Description
1	BB100055-004	Ball Retainer Spring
2	BB100060-084	Buna-N O-Ring
3	BB100060-085	Poly Check Ball
4	BB100060-04E	Tip, European Sankey
5	BB100060-04A	Tip, Domestic Sankey
6	BB100060-089	Probe O-Ring (Coupler uses 3)
7	BB100060-088	Bottom Seal (Body) Washer
8	BB100060-086E	Probe Seal Washer, European
9	BB100060-087	Probe Seal Washer, Domestic
10	BB100060-90	Check Valve
11	BB101030	Beer Nut Washer
12	BB101510	5/16" Hose Nipple
13	BB101504	Beer Nut

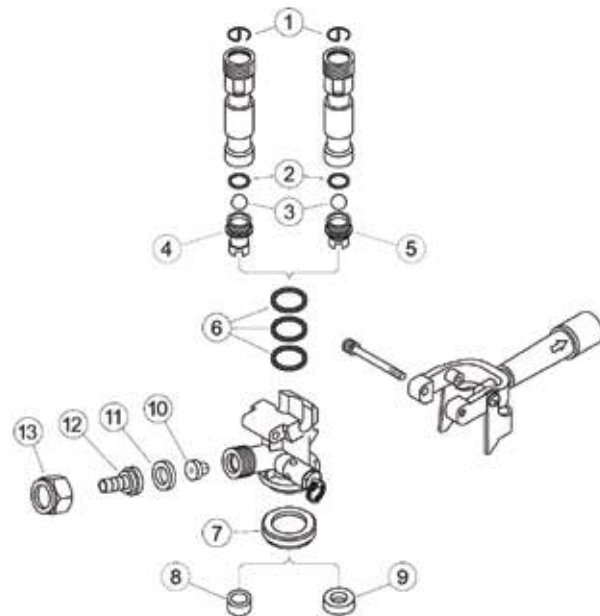

Draft Doctor

CUSTOM DESIGNED & BRANDED PRODUCTS

*You Dream It
We'll Build It!*

Trust our experienced team of talented craftsmen who work with you throughout our entire 4D process to make the tower of your dreams a reality.



Draft Doctor

Custom Design

It all starts with your *Dream*. Our talented team in our custom department works side by side with you throughout the *Design & Develop* stages to ultimately *Deliver* a uniquely crafted tower that exceeds your expectations. Our reputation for creating custom dispensing solutions is well established and we keep you - our customer, at the heart of everything we do. We will deliver your vision on time and within budget.

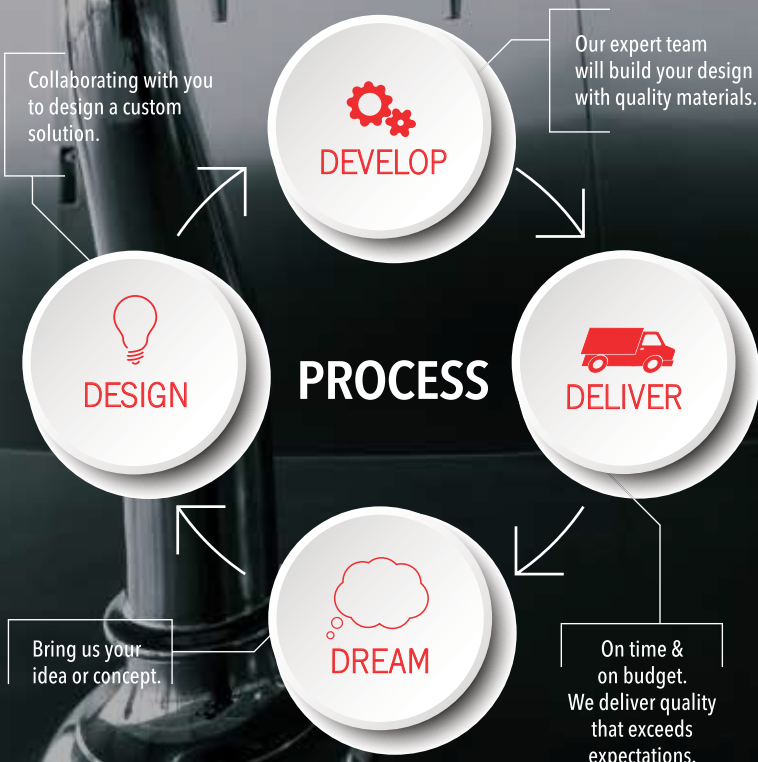

Your draft tower can be the star of your bar area. Let our experts assist you in creating the 'WOW' factor in your establishment. At CBS you can choose from a variety of options to enhance the impact of your custom designed tower. We offer lit and non-lit options, custom colors and finishes, numerous styles and material choices, all utilizing our innovative Chill-Max™ cooling technology designed to deliver colder temperatures with less energy while delivering ice cold product in every pour.



CREATE

Lighting increases visual impact of your custom tower throughout the entire day. Highlight your beer offering to your customers utilizing CBS high visibility LED lighting pods complete with branded medallions printed in house.

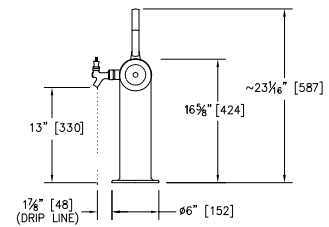
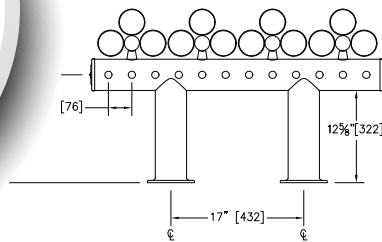
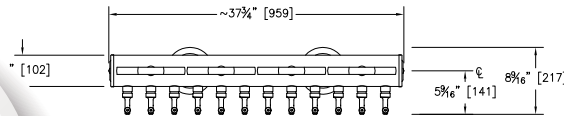

LIT MEDALLION NOTES:

1. EACH TRIPLE LED PLUG & PLAY LIGHT POD REQUIRES SIX (6) 80mm DIAMETER MEDALLIONS.
2. INCLUDED TRANSFORMER(S): (X4)
3. MAXIMUM FOUR (4) LED LIGHT PODS PER TRANSFORMER.
3. TRANSFORMER SPECIFICATION: 12V-5W-0.1A 115V.

DESIGN

Our CAD team provides precise schematics of your custom design to ensure every detail is considered.

NOTES:

1. DIMENSIONS ASSUME STANDARD DOMESTIC FAUCETS.
2. LINE/FAUCET NUMBERING STARTS WITH ONE (1) AT THE LEFT MOST FAUCET LOCATION AS DRAWN.

	YES / NO	# LINE(S)	LINE LOCATION(S)
BEER			
SODA			
WATER			
WINE			

INCLUDED MOUNTING GASKET: (X2)
1/4" THICK NEOPRENE, SIZED TO SUIT.



D&B CUSTOM 12 TAP LIT TOWER

CANADIAN BEVERAGE SUPPLY INC | DATE: 11.24.2015



Branded Products

Let CBS help you bring your brand to life. Our innovative Branded Panel kits allow you to brand your work and to help ensure that your business gets the call when service is required. At CBS it truly is about your brand!

CBS offers a complete line of Commercial Bottle/Can coolers. Custom in house branding solutions and quick turn arounds make us a great choice to partner with for all of your cold dispense needs.



Need tap handles? We offer both custom and stock solutions made from 100% Canadian Maple and painted with high quality Aircraft Grade paint to avoid chipping and cracking. Contact us today to design one just for you!



Exclusive innovation from CBS! Custom printed cooler lids are highly impactful and great for promoting your brand at festivals and special events. CBS jockey boxes are made with 304SS components to ensure your beer tastes the way you intended it to - every time!

Want to stand out from the rest? Our in-house print capabilities can help you stand out from the pack! Let CBS add your brand/design/logo to almost any tower.



WALK-IN COOLER: FOB DETECTORS

ACRYLIC FOB DETECTORS

Part Number	Description
MP551050	Tecflo Classic FOB Detector
MP551050-KIT	Tecflo Classic FOB Detector w/2 - 3/8" Barb Fittings, 1' of Drain Tube and a "Y" fitting to gang the drain tubes together
MP551055	Tecflo Deluxe FOB Detector
MP551055-KIT	Tecflo Deluxe FOB Detector w/2 - 3/8" Barb Fittings, 1' of Drain Tube and a "Y" fitting to gang the drain tubes together
MP551058	Tecflo Deluxe FOB Detector with 3/8" OD JG outlet in the Bleed Valve
MP551023	CBS FOB Detector - No Fittings
MP551024	CBS FOB Detector w/1 - 5/16" & 1 - 3/8" Barb Fitting
MP551025	CBS FOB Detector w/2 - 3/8" Barb Fitting
MP551039	DFC Wall Mt. FOB Detector w/ 3/8" OD Inlet & Outlet
MP551041	DFC Wall Mt. FOB Detector w/ Beer Thread Inlet & Outlet
MP551043	DFC Keg Mt. FOB Detector w/F. Beer Thread Inlet & M. Beer Thread Outlet

316SS FOB DETECTOR

Part Number	Description
MP551026	CBS 316SS FOB Detector - No Fittings
MP551027	CBS 316SS FOB Detector w/1 - 5/16" & 1 - 3/8" Barb Fitting
MP551028	CBS 316SS FOB Detector w/2 - 3/8" Barb Fitting

FOB FITTINGS

Part Number	Description
SF087100	1/8" Barb "Y" Fitting for FOB Drain Tubing
BT385175	1/8" ID x 3/16" OD FOB Tubing- Clear
QD100697	3/8" OD Stem x 5/16" Barb Fitting-Straight
QD100700	3/8" OD Stem x 3/8" Barb Fitting-Straight
QD100765	3/8" OD Stem x 3/8" Barb Fitting-Elbow

SS BEER RESERVOIR WITH PRV

Part Number	Description
BB101662	2 Outlet w/Beer Thread & PRV
BB101663	3 Outlet w/Beer Thread & PRV
BB101664	4 Outlet w/Beer Thread & PRV

FLOW CONTROL

Part Number	Description
MP555022	Flojet G56 Beer Pump
MP555022-RV	Flojet G56 Flow Reversal Switch
MP551060	In-Line Flow Control 3/8" OD x 5/16" OD
MP551064	SS In-Line Flow Control 5/16" SS OD x 5/16" SS OD



MP551039

MP551041

MP551023

MP551026



QD100697

QD100700

QD100765

SF087100



MP555022



BB101663



MP555022-RV



MP551060



MP551064

WALK-IN COOLER: CORNELIUS REGULATORS

CORNELIUS SECONDARY WALL-MOUNT REGULATORS

Part Number	Mounted Fitting: Top	Mounted Fitting: Left	Mounted Fitting: Bottom	Mounted Fitting: Right
CO881061C	60lb Gauge	Plug	1/4" Barb Shutoff	1/4" Barb
CO881062C	60lb Gauge	5/16" Barb	5/16" Barb Shutoff	5/16" Barb
CO881063C	60lb Gauge	Plug	5/16" Barb Shutoff	5/16" Barb
CO881065C	60lb Gauge	NONE	5/16" Barb Shutoff	NONE

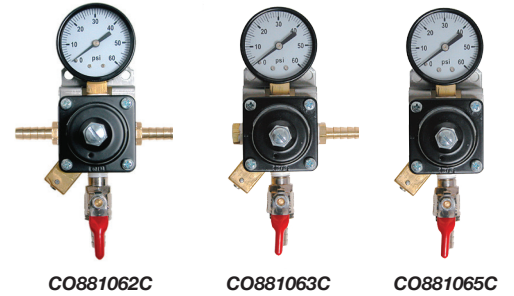

CORNELIUS GANGED SECONDARY WALL-MOUNT REGULATORS

Part Number	Mounted Fitting: Top	Mounted Fitting: Left	Mounted Fitting: Bottom	Mounted Fitting: Right
CO881260C	2 x 60lb Gauges	Plug	2 x Barb Shutoffs	5/16" Barb
CO881360C	3 x 60lb Gauges	Plug	3 x Barb Shutoffs	5/16" Barb
CO881460C	4 x 60lb Gauges	Plug	4 x Barb Shutoffs	5/16" Barb
CO881560C	5 x 60lb Gauges	Plug	5 x Barb Shutoffs	5/16" Barb
CO881660C	6 x 60lb Gauges	Plug	6 x Barb Shutoffs	5/16" Barb

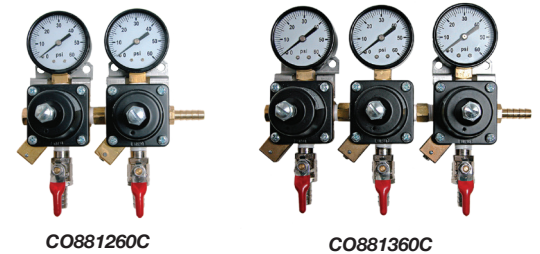

POWDER COATED PANELS

Part Number	Description
BB432040	15" White Regulator Panel - 16 ga.
BB432041	20 5/8" White Regulator Panel - 16 ga.
BB432048	24" White Regulator Panel - 16 ga.



BB432041

Custom Branded Panel

GALVANIZED PANELS

Part Number	Description
BB432043	15" Regulator Panel - 16 ga.
BB432044	20 5/8" Regulator Panel - 16 ga.
BB432045	24" Regulator Panel - 16 ga.

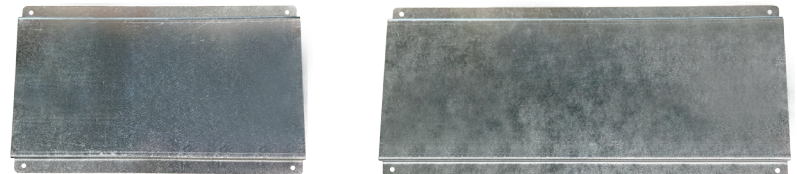

BB432043

BB432044

STANDARD CORNELIUS PANELS

Part Number	Description
CO874001C	1 Pressure / 1 Product
CO874002C	2 Pressure / 2 Products
CO874003C	3 Pressure / 3 Products
CO874004C	4 Pressure / 4 Products



CO874002C

CO874003C

DELUXE CORNELIUS PANELS

Part Number	Description
CO875001C	1 Pressure / 1 Product
CO875002C	2 Pressure / 2 Products
CO875003C	3 Pressure / 3 Products
CO875004C	4 Pressure / 4 Products

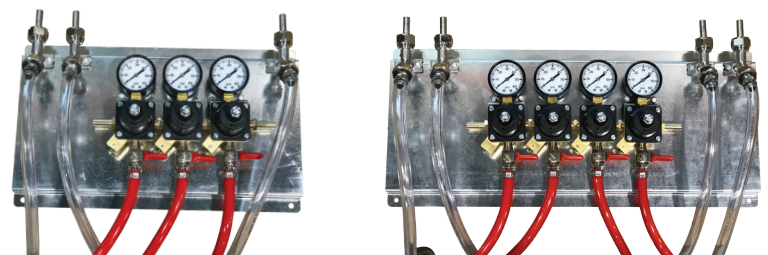

CO875003C

CO875004C

Featuring Skip Bonded Beer & Gas Jumper Hose.



TAPRITE SECONDARY WALL MOUNT REGULATORS

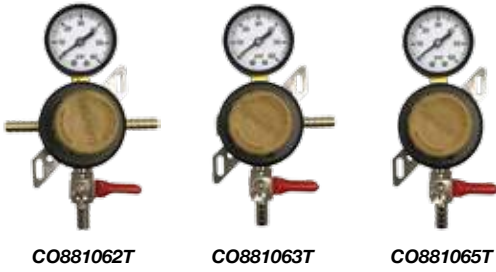

Part Number	Mounted Fitting: Top	Mounted Fitting: Left	Mounted Fitting: Bottom	Mounted Fitting: Right
CO881061T	60lb Gauge	Plug	1/4" Barb Shutoff	1/4" Barb
CO881062T	60lb Gauge	5/16" Barb	5/16" Barb Shutoff	5/16" Barb
CO881063T	60lb Gauge	Plug	5/16" Barb Shutoff	5/16" Barb
CO881065T	60lb Gauge	NONE	5/16" Barb Shutoff	NONE

TAPRITE GANGED SECONDARY WALL-MOUNT REGULATORS



Part Number	Mounted Fitting: Top	Mounted Fitting: Left	Mounted Fitting: Bottom	Mounted Fitting: Right
CO881260T	2 x 60lb Gauges	Plug	2 x 5/16" Barb Shutoff	5/16" Barb
CO881360T	3 x 60lb Gauges	Plug	3 x 5/16" Barb Shutoff	5/16" Barb
CO881460T	4 x 60lb Gauges	Plug	4 x 5/16" Barb Shutoff	5/16" Barb
CO881560T	5 x 60lb Gauges	Plug	5 x 5/16" Barb Shutoff	5/16" Barb
CO881660T	6 x 60lb Gauges	Plug	6 x 5/16" Barb Shutoff	5/16" Barb



CO874002T



CO874004T

TAPRITE STANDARD PANELS

Part Number	Description
CO874001T	1 Pressure / 1 Product
CO874002T	2 Pressure / 2 Products
CO874003T	3 Pressure / 3 Products
CO874004T	4 Pressure / 4 Products

ASSEMBLED DELUXE PANEL KITS INCLUDE:

- Galvanized panel
- Secondary Regulator(s)
- 3/8" 304SS Wall Brackets
- 3/8" 304SS Barb Fittings
- Neoprene Washers
- 8'- 3/8" ID Clear Vinyl Tubing
- 8'- 5/16" ID Red Vinyl Tubing
- Beer Nuts
- Wing Nuts
- Stepless Clamps
- 2- 5/16" Brass Barb Fittings
- 1-1/4" Brass Plug



CO875003T

TAPRITE DELUXE PANELS

Part Number	Description
CO875001T	1 Pressure / 1 Product
CO875002T	2 Pressure / 2 Products
CO875003T	3 Pressure / 3 Products
CO875004T	4 Pressure / 4 Products

Featuring Skip Bonded Beer & Gas Jumper Hose.



CO875004T

WALK-IN COOLER: SPECIALTY PANEL KITS

BEER PUMP KITS

Part Number	Description
CO869211T	Beer Pump Kit Includes: 1 x Flojet G56 Beer Pump 1 x Flojet G56 Pump Flow Reversal Valve 1 x 304SS Wall Bracket 1 x CBS Plastic FOB 1 x T. Secondary Regulator Skip Bonded Beer and Gas Jumper Hose
CO869212C	Beer Pump Kit includes: 2 x Flojet G56 Beer Pumps 2 x Flojet G56 Pump Flow Reversal Valves 2 x 304SS Wall Brackets 2 x CBS Plastic FOBs 2 x C. Secondary Regulators Skip Bonded Beer and Gas Jumper Hose

CBS beer pump kits are completely customizable.

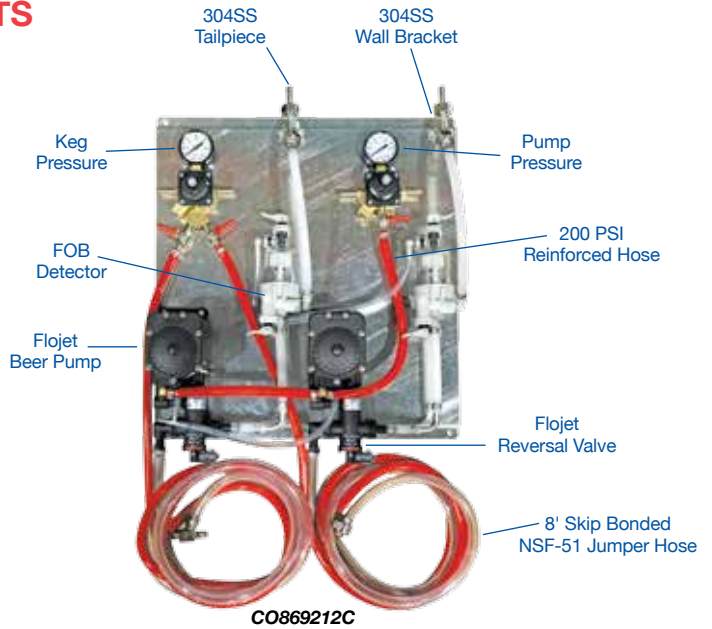

SKIP BONDED JUMPER HOSE:

- 3/8" ID x 5/8" OD Clear Vinyl NSF-51 certified tubing, skip bonded together with 5/16" ID x 9/16" OD Red Vinyl NSF-51 certified tubing
- Safer as there are no sharp edges from cut cable ties
- Maintains integrity of the hose for a perfect pour



SKIP BONDED NSF-51 JUMPER HOSES ARE STANDARD ON ALL CBS DELUXE REGULATOR, BEER PUMP & FOB PANEL KITS.

FOB DETECTOR KITS

Part Number	Description
CO869416T	1P T. Deluxe FOB Panel
CO869417C	2P C. Deluxe FOB Panel
CO869426T	1P T. CBS-PL FOB Panel
CO869427C	2P C. CBS-PL FOB Panel
CO869428C	3P C. CBS-PL FOB Panel
CO869429T	4P T. CBS-PL FOB Panel
CO869436C	1P C. 316SS FOB Panel
CO869436T	1P T. 316SS FOB Panel
CO869437C	2P C. 316SS FOB Panel
CO869437T	2P T. 316SS FOB Panel
CO869440T	3P T. 316SS FOB Panel
CO869442C	4P C. 316SS FOB Panel

CBS FOB DETECTOR KITS ARE CUSTOMIZABLE AND INCLUDE:

- Fob Detectors (Acrylic or 316SS)
- Secondary Regulators (Taprite or Cornelius)
- 304SS Wall Brackets
- 304SS Tailpieces
- 8' Skip Bonded Beer & Gas Jumper Hose
- Fittings, Washers & Clamps
- Assembly
- Branding (Optional)

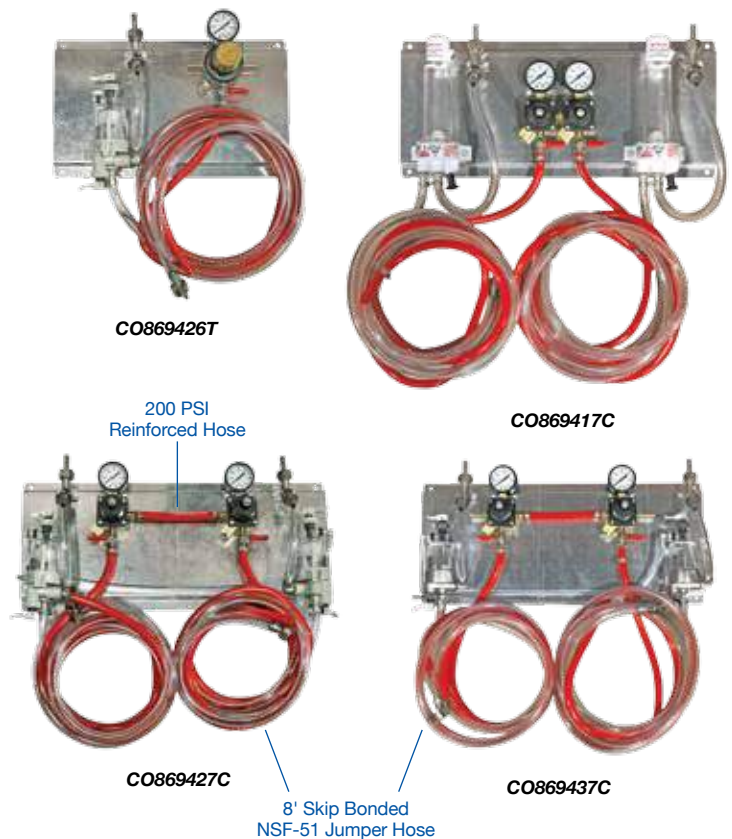



BB80100-25-75



BB802-25/75-60/40

MCDANTIM GAS BLENDERS

Part Number	Description
BB80100-25-75	Trumix® Single Blender Gas Blender-25%CO ₂ -75%N ₂
BB80100-60-40	Trumix® Single Blender Gas Blender-60%CO ₂ -40%N ₂
BB802-25/75-50/50	Trumix® Double Gas Blender-25%CO ₂ -75%N ₂ + 50%CO ₂ -50%N ₂
BB802-25/75-60/40	Trumix® Double Gas Blender-25%CO ₂ -75%N ₂ + 60%CO ₂ -40%N ₂
BB802-30/70-50/50	Trumix® Double Gas Blender-30%CO ₂ -70%N ₂ + 50%CO ₂ -50%N ₂
BB803-256050	Trumix® Triple Gas Blender-60%CO ₂ -40%N ₂ + 25%CO ₂ -75%N ₂ + 50%CO ₂ -50%N ₂



BB801013



BB801042



BB801044



BB801045

MCDANTIM GAS BLENDER COMPONENTS

Part Number	Description
BB801013	In-Line Check Valve "T"-1/4" x 1/4" x 1/4"
BB801042	In-Line Check Valve "T"-3/8" x 3/8" x 3/8"
BB801044	In-Line Check Valve "T"-1/4" x 3/8" x 1/4"
BB801045	In-Line Check Valve "T"-1/4" x 3/8" x 3/8"



BB101611



BB101612



BB101612



BB101614

METAL GAS DISTRIBUTORS

Part Number	Description
BB101611	1 Way Distributor w/Shut-Off, Plug and 5/16" Barb Fitting
BB101612	2 Way Distributor w/Shut-Offs, Plug and 5/16" Barb Fitting
BB101613	3 Way Distributor w/Shut-Offs, Plug and 5/16" Barb Fitting
BB101614	4 Way Distributor w/Shut-Offs, Plug and 5/16" Barb Fitting



CO881739



CO881751



CO882020



CO881723

METAL GAS DISTRIBUTOR COMPONENTS

Part Number	Description
CO881739	1/4" MPT x 5/16" Barb Fitting
CO881751	1/4" MPT Plug
CO882020	1/4" MPT x 5/16" Barb Shut-Off
CO881723	1/4" MPT x 1/4" MPT Union



BB803510

MCDANTIM GAS ANALYZERS

Part Number	Description
BB803510	MV020 Beer Check w/Adapter

WALK-IN COOLER: FLOW MONITORING SYSTEMS & KEG ORGANIZERS

CBS stocks a large selection of flow monitors to accommodate any size system! Please ask your CBS Sales Representative for details.



FM200222

Designed to work in Portable Draught Beer Dispensers.

FLOW MONITORING SYSTEMS

Part Number	Description
FM200222	Two-Line Flow Monitor - Powered by 2 x AA Batteries
FM200244	6 Line Flow Monitor - 12V AC Power Source
FM200288	16 Line Flow Monitor - 12V AC Power Source - Includes Draft Manager Software



FM200288



FM200244

FLOW MONITORING SYSTEM COMPONENTS

Part Number	Description
FM200215	In-Line Flowmeter Turbine - 3/16" Bore



FM200215

✶ TAILPIECES AND WASHERS SOLD SEPARATELY

ORGANIZE YOUR KEGS!

CBS offers safe storage and transport solutions for Kegs in a Walk-in Cooler. Use the Keg Storage Stacker or Keg Series Stacker to increase the storage capacity in a Walk-in Cooler and use the Keg Dolly for safe transport of full Kegs.

KEG STORAGE STACKER

Part Number	Description
BB702600	Keg Organizer
BB702590	Keg Organizer - Slim Kegs



BB702600



BB702590

KEG SERIES STACKER

Part Number	Description
BB702603	Keg Stacker
BB702593	Keg Stacker - Slim Kegs



BB702603



BB702593

KEG DOLLY

Part Number	Description
BB702604	Keg Dolly



BB702604

CORNELIUS – PRIMARY REGULATORS



CO882061C



CO882061C-2

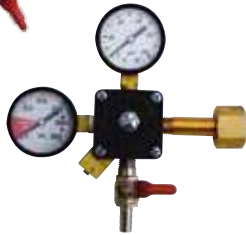

CO882101C



CO882161C



CO892060C



CO892100C

Part Number	Mounted Fitting: Top	Mounted Fitting: Left	Mounted Fitting: Bottom	Mounted Fitting: Right
CO882061C	60lb Gauge	3000lb Gauge	5/16" Barb Shutoff	CO ₂ Stem & Nut
CO882061C-2	60lb Gauge	3000lb Gauge	2 x 5/16" Barb Shutoffs	CO ₂ Stem & Nut
CO882101C	100lb Gauge	3000lb Gauge	5/16" Barb Shutoff	CO ₂ Stem & Nut
CO882161C	160lb Gauge	3000lb Gauge	5/16" Barb Shutoff	CO ₂ Stem & Nut
CO892060C	60lb Gauge	3000lb Gauge	5/16" Barb Shutoff	N ₂ Stem & Nut
CO892100C	100lb Gauge	3000lb Gauge	5/16" Barb Shutoff	N ₂ Stem & Nut
CO892160C	160lb Gauge	3000lb Gauge	5/16" Barb Shutoff	N ₂ Stem & Nut



CO882061T



CO892060T

TAPRITE – PRIMARY REGULATORS

Part Number	Description
CO882061T	60lb CO ₂ Primary Regulator w/Shut-Off
CO892060T	60lb N ₂ Primary Regulator w/Shut-Off
CO882161T	160lb CO ₂ Primary Regulator w/Shut-Off
CO892160T	160lb N ₂ Primary Regulator w/Shut-Off



CO772160-CGG

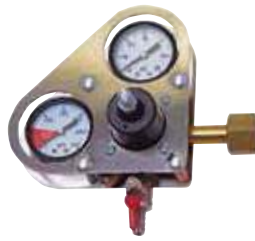

CO772061-CGG

CORNELIUS – PRIMARY REGULATOR WITH GAUGE GUARD

Part Number	Description
CO772060-CGG	60lb N ₂ Primary Regulator w/Gauge Guard
CO772061-CGG	60lb CO ₂ Primary Regulator w/Gauge Guard
CO772100-CGG	100lb N ₂ Primary Regulator w/Gauge Guard
CO772101-CGG	100lb CO ₂ Primary Regulator w/Gauge Guard
CO772160-CGG	160lb N ₂ Primary Regulator w/Gauge Guard
CO772161-CGG	160lb CO ₂ Primary Regulator w/Gauge Guard



CO772061-TGG



CO772060-TGG

TAPRITE – PRIMARY REGULATOR WITH GAUGE GUARD

Part Number	Description
CO772060-TGG	60lb N ₂ Primary Regulator w/Gauge Guard
CO772061-TGG	60lb CO ₂ Primary Regulator w/Gauge Guard

REGULATORS: REGULATOR COMPONENTS

REGULATOR FITTINGS

Part Number	Description
CO881752	(1) 1/4" M.P.T. x (2) 1/4" F.P.T. "Y" Fitting
CO881975	CO ₂ Bottle to N ₂ Regulator Adapter
CO881977	N ₂ Bottle to CO ₂ Regulator Adapter
CO881995	1200PSI Check Valve
CO882000	Ball Valve with 1/4" Pipe Thread In/Outlet
CO880099	Nylon CO ₂ Washer
CO892102	N ₂ Nipple O'Ring
CO880095	Fibre Washer



REGULATOR SHUT-OFFS

Part Number	Description
CO882015	1/4" Barbed Shutoff
CO882020	5/16" Barbed Shutoff
CO882029	5/16" Barbed Shutoff
CO882028	5/16" Barbed Shutoff with Check Valve



REGULATOR GAUGES

Part Number	Description
CO890030	30lb Gauge
CO890060	60lb Gauge
CO890100	100lb Gauge
CO890160	160lb Gauge
CO891800	3000lb Gauge with Red "Order Gas" Zone Label - Lefthand Thread



GAUGE GUARDS

Part Number	Description
CO898810-C	Cornelius SS Gauge Guard
CO898810-T	Taprite/MMe Metal Gauge Guard

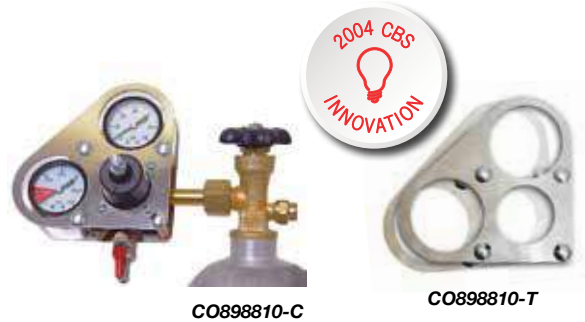

REGULATOR WRENCHES

Part Number	Description
CO898804	CO ₂ Wrench



CO₂ CHANGEOVER VALVES

Part Number	Description
CO898812	CO ₂ Changeover Valve
CO898812-P	CO ₂ Changeover Valve-minus the check valves



BULK CO₂ RESERVE KIT

Part Number	Description
CO2RS-C	Cornelius 160 lb CO ₂ Bottle Mount Regulator, Changeover Valve and Bulk System Gauge with Manifold Check Valve and Shut-Off.

Convert your old fridge into a beer dispenser!

REFRIGERATOR CONVERSION KITS

REFRIGERATOR CONVERSION KITS

CBS Refrigerator Conversion Kits are the perfect solution to convert a standard refrigerator into a self-contained direct draw draught beer dispenser! Each kit comes complete with everything needed to dispense draught beer! Just add beer and CO₂ and you can dispense draught beer anywhere!

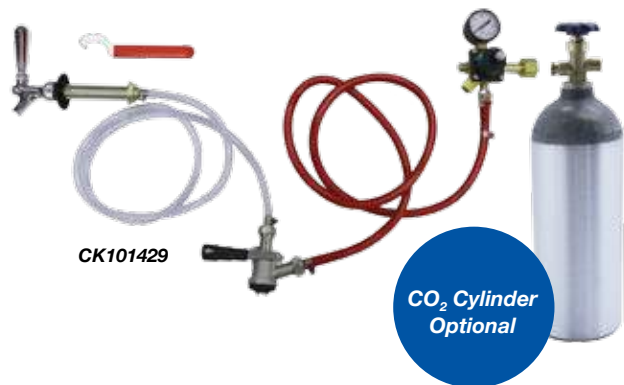

BASIC REFRIGERATOR CONVERSION KIT

Part Number	Description
CK101429	Basic Conversion Kit

KIT INCLUDES:

- "D" System Keg Coupler
- Single Gauge CO₂ Regulator
- 4' of Red Air Tubing
- 5' of Clear Beer Tubing
- 5 1/8" Shank
- Fittings, Washers & Clamps
- Chrome Faucet
- Chrome Tap Handle
- Faucet Wrench

STANDARD REFRIGERATOR CONVERSION KIT



Part Number	Description
CK101465	Standard Conversion Kit

KIT INCLUDES:

- "D" System Keg Coupler
- Single Gauge CO₂ Regulator
- 4' of Red Air Tubing
- 5' of Clear Beer Tubing
- 5 1/8" Shank
- Fittings, Washers & Clamps
- Drip Tray
- Chrome Faucet
- Chrome Tap Handle
- Faucet Wrench
- CO₂ Wrench

CK101465

DELUXE REFRIGERATOR CONVERSION KIT



Part Number	Description
CK101467	Deluxe Conversion Kit

KIT INCLUDES:

- "D" System Keg Coupler
- Double Gauge CO₂ Regulator
- 4' of Red Air Tubing
- 5' of Clear Beer Tubing
- 5 1/8" Shank
- Fittings, Washers & Clamps
- Drip Tray
- Chrome Faucet
- Chrome Tap Handle
- Deluxe Faucet Wrench
- CO₂ Wrench
- Faucet Cleaning Brush

CK101467

REFRIGERATOR CONVERSION KITS

PREMIUM REFRIGERATOR CONVERSION KIT

Part Number	Description
CK101479	Premium Conversion Kit

KIT INCLUDES:

- "D" System Keg Coupler
- Double Gauge CO₂ Regulator
- Chrome Faucet
- 4' of Red Air Hose
- 5' of Clear Beer Tube with Beer Fittings
- 5 1/8" Shank
- Fittings, Washers & Clamps
- Chrome Tap Handle
- 6" x 6" x 11" SS Drip Tray
- CO₂ Wrench
- Faucet Brush
- Cleaning Kit
- Deluxe Faucet Wrench



STANDARD DUAL KIT

Part Number	Description
CK101465-X2	Standard Dual Kit

KIT INCLUDES:

- 2-"D" System Keg Couplers
- Double Gauge CO₂ Regulator w/2 Shut-Offs
- 2-Chrome Faucets
- 2-4' Red Air Hose
- 2-5' Clear Beer Tube with Beer Fittings
- 2-5 1/8" Shanks
- Fittings, Washers & Clamps
- 2 Chrome Tap Handles
- Drip Tray
- CO₂ Wrench
- Faucet Wrench



STANDARD TOWER KIT

Part Number	Description
CK101515	Standard Tower Kit

KIT INCLUDES:

- "D" System Keg Coupler
- Double Gauge CO₂ Regulator
- 3" Diameter Single Chrome Beer Tower with 5' of 3/16" Tubing and Beer Fittings
- 4' of Red Air Hose Clamps
- Chrome Tap Handle
- CO₂ Wrench
- Faucet Wrench



REFRIGERATOR CONVERSION KITS: PARTS AND CLEANING



CP151040-KIT

1 QUART CLEANING KIT

Part Number	Description
CP151040-KIT	1 Quart Cleaning Kit

KIT INCLUDES:

- 1qt Plastic Bottle with Metal Pump
- Faucet Wrench
- Faucet Brush
- Beer Line Cleaner - 4oz Bottle

CONVERSION KIT PARTS & ACCESSORIES

Part Number	Description
OC99-04	#4 Gear Clamps
OC99-05	#5 Gear Clamps
CP101748	4oz Bottle "BLC" Cleaner
BB100990	TOF "D" System Keg Coupler
CO882069C	Standard Kit Replacement Regulator
CO882061C	Deluxe Kit Replacement Regulator
MP110001	Ball Lock Quick Disconnect - Gas with 1/4" Barb
MP110002	Ball Lock Quick Disconnect - Liquid with 1/4" Barb
MP100099	Pin Lock Quick Disconnect - Gas with 1/4" Barb
MP100000	Pin Lock Quick Disconnect - Liquid with 1/4" Barb
MP110003	Ball Lock Quick Disconnect - Gas with 1/4" MFL
MP110004	Ball Lock Quick Disconnect - Liquid with 1/4" MFL
MP110020	Faucet to Disconnect Adapter
MP110026	Pump to Disconnect Adapter



BB100990



OC99-04



CO882061C



CP101748



CO888993



CO888990



CO888987

CO₂ CYLINDERS

Part Number	Description
CO888987	2.5lb Aluminum Cylinder
CO888990	5lb Aluminum Cylinder
CO888993	10lb Aluminum Cylinder
CO889000	20lb Aluminum Cylinder



CO892060C



BB101254G



BB101254

OPTIONAL COMPONENTS

Part Number	Description
BB101254	Polished 303SS Stout Faucet
BB101254G	Gold Plated 303SS Stout Faucet
CO892060C	Primary N ₂ Regulator

Conversion kits are customizable!
Please ask your CBS sales representative for details.

SPECIAL EVENT DISPENSE

PLASTIC PICNIC COOLERS WITH STAINLESS STEEL COIL

Part Number	Description
CL105420	48qt Cooler with One 50' SS Coil
CL105423	48qt Cooler with One 85' SS Coil
CL105425	48qt Cooler with One 120' SS Coil
CL105430	48qt Cooler with Two 50' SS Coils
CL105433	48qt Cooler with Two 85' SS Coils
CL105435	48qt Cooler with Two 120' SS Coils
CL105450	100qt Cooler with Three 120' SS Coils

* Coil Picnic Coolers include **304SS** Faucets, **304SS** Shanks, **304SS** Coils and **304SS** Picnic Cooler Couplings

BRANDED PLASTIC PICNIC COOLERS WITH STAINLESS STEEL COIL

Part Number	Description
CL105420B-BR	Branded Blue 48qt Cooler with One 50' SS Coil
CL105420R-BR	Branded Red 48qt Cooler with One 50' SS Coil
CL105423B-BR	Branded Blue 48qt Cooler with One 85' SS Coil
CL105423R-BR	Branded Red 48qt Cooler with One 85' SS Coil
CL105425B-BR	Branded Blue 48qt Cooler with One 120' SS Coil
CL105425R-BR	Branded Red 48qt Cooler with One 120' SS Coil
CL105430B-BR	Branded Blue 48qt Cooler with Two 50' SS Coils
CL105430R-BR	Branded Red 48qt Cooler with Two 50' SS Coils
CL105433B-BR	Branded Blue 48qt Cooler with Two 85' SS Coils
CL105433R-BR	Branded Red 48qt Cooler with Two 85' SS Coils
CL105435B-BR	Branded Blue 48qt Cooler with Two 120' SS Coils
CL105435R-BR	Branded Red 48qt Cooler with Two 120' SS Coils

* Coil Picnic Coolers include **304SS** Faucets, **304SS** Shanks, **304SS** Coils and **304SS** Picnic Cooler Couplings

BRANDED SS PICNIC COOLERS WITH STAINLESS STEEL COIL

Part Number	Description
CL105550-1BR	Branded 54qt Cooler with One 50' Stainless Steel Coil
CL105550-2BR	Branded 54qt Cooler with Two 50' Stainless Steel Coils
CL105550-3BR	Branded 54qt Cooler with Three 50' Stainless Steel Coils
CL105552-1BR	Branded 54qt Cooler with One 85' Stainless Steel Coil
CL105552-2BR	Branded 54qt Cooler with Two 85' Stainless Steel Coils
CL105553-1BR	Branded 54qt Cooler with One 120' Stainless Steel Coil
CL105553-2BR	Branded 54qt Cooler with Two 120' Stainless Steel Coils

* Coil Picnic Coolers include **304SS** Faucets, **304SS** Shanks, **304SS** Coils and **304SS** Picnic Cooler Couplings

PLASTIC PICNIC COOLERS WITH COLD PLATE

Part Number	Description
CL105520	48qt Cooler with One Tap - 8" x 12" Cold Plate
CL105522	48qt Cooler with Two Taps - 8" x 12" Cold Plate
CL105530	48qt Cooler with One Tap - 10" x 15" Cold Plate
CL105540	48qt Cooler with Two Taps - 10" x 15" Cold Plate
CL105542	48qt Cooler with Three Taps - 10" x 15" Cold Plate
CL105545	48qt Cooler with Four Taps - 10" x 15" Cold Plate



CL105425



CL105435



Shown with optional lid graphics.





CL202054



BRANDED PICNIC COOLERS

Part Number	Description
CL202054	54qt SS Picnic Cooler Wrapped with Custom Graphics - No Hardware
CL202040-R	Red 48qt Plastic Picnic Cooler With Custom Graphics - No Hardware
CL202042-B	Blue 48qt Plastic Picnic Cooler With Custom Graphics - No Hardware



CL202040-R



CL202042-B

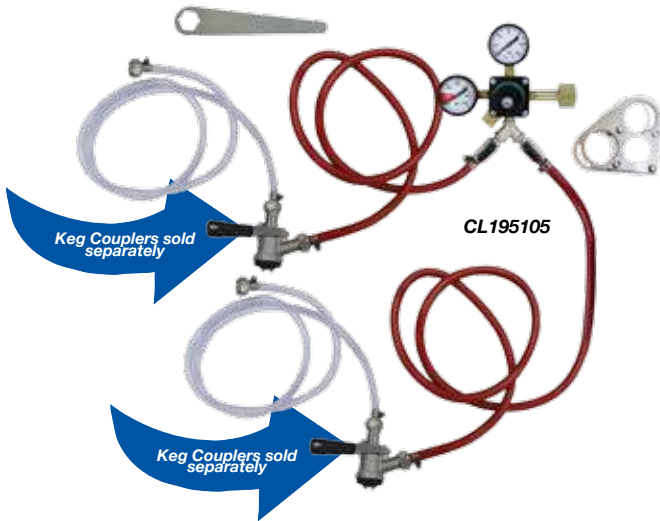

CL195105

TAPPING KITS FOR PICNIC COOLERS

Part Number	Description
CL195100	CO ₂ Tapping Kit For 1 Tap Picnic Cooler
CL195105	CO ₂ Tapping Kit For 2 Tap Picnic Cooler
CL195150	N ₂ Tapping Kit For 1 Tap Picnic Cooler
CL195155	N ₂ Tapping Kit For 2 Tap Picnic Cooler

Tapping Kits include: Tubing, Clamps, Fittings, Primary Regulator with SS Gauge Guard and Wrench.

BREEZE ICE COOLED BEER DISPENSER

Part Number	Description
CL175001	1T Breeze Ice Cooled Draught Beer Dispenser
CL175001-3BR	1T Breeze Ice Cooled Draught Beer Dispenser w/3 Sides Wrapped
CL175001-4BR	1T Breeze Ice Cooled Draught Beer Dispenser w/4 Sides Wrapped



CL175001



CL175001-4BR



BB702718

INSULATED KEG JACKET

Part Number	Description
BB702710	20L Insulated Keg Jacket
BB702718	58L Insulated Keg Jacket
BB702785	Insulated Keg Wrap - Long enough to wrap 4-58L Kegs "Keep Kegs cold during transport!"

SPECIAL EVENT DISPENSE

304SS COILS

Part Number	Description	Shape
CL106305	50' x 5/16" OD	Round
CL106150L	50' 5/16" OD - Left	Round
CL106150R	50' 5/16" OD - Right	Round
CL106310	50' 5/16" OD - Left/Right	Square
CL106315	85' 5/16" OD - Left/Right	Square
CL106212L	120' (100' x 3/8" OD + 20' x 1/4" OD - Left	Round
CL106212R	120' (100' x 3/8" OD + 20' x 1/4" OD - Right	Round
CL106320	120' x 5/16" OD - Left/Right - Includes an inline Flow Control - MP551064	Square



CL106320



MP551064



CL106305



CL106310



CL106315

COLD PLATES WITH 1/4" BARB FITTINGS

Part Number	Description
CL000099	One Channel 8" x 12"
CL000100	Two Channel 8" x 12"
CL011015	One Channel 10" x 15"
CL021015	Two Channel 10" x 15"



CL000100

COOLER COUPLING

Part Number	Description
CL106999	3" Cooler Coupling with Assembly - 3/8" Bore
CL107010	3" 304SS Cooler Coupling Assembly - 3/8" Bore
BB101189-02	Cooler Coupling Washer



BB101189-02



CL106999

SHANKS

Part Number	Description
BB101297	3" Shank Assembly with Barb Fitting
BB101297-SS	3" 304SS Shank Assembly with Barb Fitting
BB101300-1/4	3" Shank Assembly with 1/4" Bore
BB101295-3SS	3" 304SS Shank Assembly



BB101297



BB101295-3SS



LEVER HANDLE - "D" SYSTEM

Part Number	Description
BB202768	4" Lever Handle with Chrome Plated Metal Pump
BB202768-X8	8" Lever Handle with Chrome Plated Metal Pump

LEVER HANDLE - "S" SYSTEM

Part Number	Description
BB202768E	4" Lever Handle with Chrome Plated Metal Pump
BB202768E-X8	8" Lever Handle with Chrome Plated Metal Pump



LEVER HANDLE - EUROPEAN

Part Number	Description
BB202776	4" Lever Handle "A" System with Chrome Plated Metal Pump
BB202776-X8	8" Lever Handle "A" System with Chrome Plated Metal Pump
BB202778	4" Lever Handle "G" System with Chrome Plated Metal Pump
BB202778-X8	8" Lever Handle "G" System with Chrome Plated Metal Pump
BB202780	4" Lever Handle "U" System with Chrome Plated Metal Pump
BB202780-X8	8" Lever Handle "U" System with Chrome Plated Metal Pump



BRONCO PUMPS

Part Number	Description
BB202740	Bronco Pump with "D" System Coupler
BB202741	Bronco Pump with "S" System Coupler

PICNIC PUMP - LESS COUPLER

Part Number	Description
BB202754	8" Metal Picnic Pump & Faucet-Less Coupler



WING HANDLE - "D" SYSTEM

Part Number	Description
BB202758	4" Metal Wing Handle with Chrome Plated Metal Pump
BB202758-X8	8" Metal Wing Handle with Chrome Plated Metal Pump

WING HANDLE - PERLICK PARTY PUMPS

Part Number	Description
BB089970	Perlick Party Pump with "D" System Coupler
BB089973	Perlick Party Pump with "S" System Coupler



CBS STOCKS CLEANING CANS AND CHEMICALS TO CLEAN PICNIC PUMPS (PG.83-85)

To clean your Picnic Pump, fill the cleaning bottle with water and cleaning chemical and connect the Picnic Pump to the bottle cap on top of the cleaning can. Pump the solution through the pump and out of the faucet. Rinse the cleaning bottle, add fresh water and pump the water through the pump and out of the faucet to complete the second stage of the cleaning process. Contact your CBS representative for more details.

PARTY PUMPS

DELUXE METAL PUMPS

Part Number	Description	System
BB202750	Deluxe 8" Pump-No Coupler	Pump Less Coupler
BB202752	Deluxe 8" Pump with Lever Handle "D" Coupler and Faucet	"D" System
BB202752-XS	Deluxe 8" Pump with Lever Handle "S" Coupler and Faucet	"S" System
BB202752-XA	Deluxe 8" Pump with Lever Handle "A" Coupler and Faucet	"A" System
BB202752-XG	Deluxe 8" Pump with Lever Handle "G" Coupler and Faucet	"G" System
BB202752-XU	Deluxe 8" Pump with Lever Handle "U" Coupler and Faucet	"U" System



PICNIC PUMP PLASTIC FAUCET

Part Number	Description
BB101230	Plastic Faucet With Barb
BB101450-2	Plastic Faucet with 2' of Black Hose and Hexnut
BB101450-L2	Plastic Faucet with 2' of Black Hose-Less Hexnut

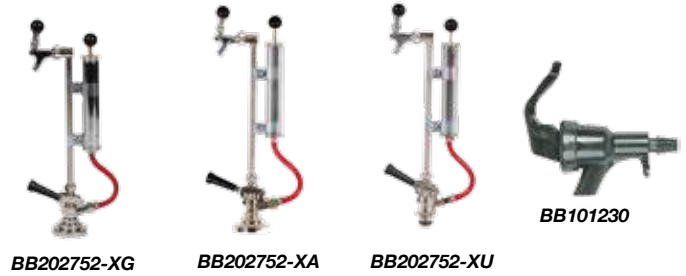

METAL PUMP REPLACEMENT PARTS

Part Number	Description
BB101030	Neoprene Beer Nut Washer - NSF Certified
BB101031	Thomas Vent
BB101032	Body Washer
BB101033	Probe Washer
BB202750-17	Figure "8" Washer for Twin Probe
BB202750-18	Check Valve for Twin Probe Tap



METAL PUMP ADAPTERS

Part Number	Description
BB202750-7	Pump Adapter Converts BB202750-234 to 5/16" Hose
BB202750-7N	Pump Adapter Replaces Air Nipple on Sankey to Attach BB202750-234
BB202750-282	Vertical Swivel Connector to Connect Pump to Coupler



REPLACEMENT METAL PUMPS

Part Number	Description
BB202750-233	4" Chrome Plated Pump with Thread and Check Valve
BB202750-234	8" Chrome Plated Pump with Thread and Check Valve
BB202750-235	8" Chrome Plated Pump with 5/16" Barb



BRONCO PUMP PARTS

Part Number	Description
BB202745-01	Bronco Pump Piston O'Ring
BB202745-02	Bronco Pump Locking Ring
BB202745-03	Bronco Pump Air Seal
BB202745-04	Bronco Pump Beer Seal
BB202745-05	Bronco Pump Piston



LUBRICANT

Part Number	Description
BB101707	O'Ring Lubricant





CP101824 CP101804 CP101790 CP101748 CP101739

PENETRATE

Part Number	Description
CP101739	4oz Penetrate
CP101740	32oz Penetrate
CP101745	55gal Penetrate

POWERFUL LIQUID CLEANER FOR BEER AND BEVERAGE SYSTEMS. FORMULATED FOR ROUTINE CLEANING OF STUBBORN SYSTEMS



CP103145 MP900105 CP101736 CP101788

BEER LINE CLEANER (BLC)

Part Number	Description
CP101748	4oz BLC
CP101750	32oz BLC
CP101755	55gal BLC

CONCENTRATED LIQUID CLEANER FOR BEER AND BEVERAGE LINES. WORKS IN A VARIETY OF CLEANING EQUIPMENT (PUMPS, PRESSURE TANKS ETC.)



CP101765 CP101770-5

DOUBLE ALKALINE CLEANER (DAC)

Part Number	Description
CP101801	4oz DAC
CP101804	32oz DAC
CP101810	55gal DAC

VERY POWERFUL LIQUID CLEANER FOR BEER AND BEVERAGE SYSTEMS. FORMULATED WITH TWIN ALKALINE COMPOUNDS FOR CLEANING PROBLEMATIC SYSTEMS

POWDER LINE CLEANER (PLC)

Part Number	Description
CP101758	2.25oz PLC
CP101760	25oz PLC
CP101762	48oz PLC
CP101765	40lb PLC

ACID LINE CLEANER (ALC)

Part Number	Description
CP101821	4oz ALC
CP101824	32oz ALC
CP101830	55gal ALC

CONCENTRATED LIQUID LINE CLEANER THAT TARGETS CALCIUM OXALATE IN DRAUGHT BEER SYSTEMS

SUPER "NO RINSE" LINE CLEANER

Part Number	Description
CP101768	2.25oz Super "No Rinse"
CP101770-5	5lb Super "No Rinse"
CP101771	40lb Super "No Rinse"

TM DESANA MAX - COLOR CHANGE TECHNOLOGY

Part Number	Description
CP103100	T.M. Desana Max 1.9oz Packet

TM DESANA IC - COLOR CHANGE TECHNOLOGY

Part Number	Description
CP103145	4 Litre Desana IC Liquid

WINE LINE CLEANER (WLC)

Part Number	Description
CP101788	2.25oz WLC
CP101790	32oz WLC
CP101796	55gal WLC

BENEFIT CLEANER

Part Number	Description
MP900105	4 Litre Benefit

ALLKLEAR TABLETS

Part Number	Description
CP101736	allKlear Rinse Indicator-200 Tablets

CLEANING

TDC DETERGENT

Part Number	Description
CP102051	5 Tablet TDC Tab-Det Detergent
CP102053	100 Tablet TDC Tab-Det Detergent
CP102058	72 Pouch Triple Duty Concentrate Detergent



LFD DETERGENT

Part Number	Description
CP102071	5 Tablet LFD Tab Detergent Tablets
CP102073	100 Tablet LFD Tab Detergent Tablets
CP102079	72 Pouch Low Foam Detergent

BTF SANITIZER

Part Number	Description
CP102091	5 Tablet BTF CHLOR-TAB Sanitizer
CP102093	100 Tablet BTF CHLOR-TAB Sanitizer
CP102098	72 Pouch BTF Sanitizer



FLUSHERS

Part Number	Description
CP101699	SS Series Flusher - "D" and "S" with Integral Ball Lifter
CP101700	SS Series Flusher - "D" and "S", No Ball Lifter
CP101701	SS Double Flusher - "D" and "S" with Integral Ball Lifter
CP101698	Lexan Series Flusher - "D" and "S", No Ball Lifter
CP101690	SS Series Flusher - "G"
CP101692	Plastic Series Flusher - "U"
CP101693	SS Series Flusher - "A"
CP101694	SS Single Flusher - "A"



ACCESSORIES

Part Number	Description
CP101716	Faucet Cleaning Attachment with Barb
CP101718	Duplex Coupling
CP101727	European Faucet Cleaning Attachment with Barb
CP101327SS	304SS 1/2" BSP European Shank with US Coupling Nut

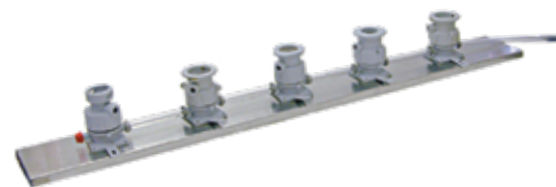

Build a custom, portable clean in-place system with components from CBS

CLEANING TOOLS

Part Number	Description
CP101712	8" x 3/4" Faucet Brush
CP101713	7" x 3/16" SS Brush
CP101714	7" x 1/4" SS Brush
BB101719	Faucet Wrench
BB101721	Deluxe Faucet Wrench
CP101722	8 1/2" x 3/4" Faucet Brush
CP101724	9" x 5/8" SS Faucet Brush



IN-PLACE PORTABLE CLEANING

Part Number	Description
CP151130	"D" System Cleaning Socket
CP151132	"S" System Cleaning Socket
CP151133	"U" System Cleaning Socket
CP151134	"A" System Cleaning Socket
CP151135	"G" System Cleaning Socket
CP151140	Back Plate
CP151142	End Stop Cap
CP151100	SS Mounting Board with Handle



MAXI-VAC LINE CLEANING PUMPS

Part Number	Description
CP151300	Maxi-Vac Medium Duty Re-Circulating Line Cleaning Pump Up to 300'
CP151304	Maxi-Vac Heavy Duty Re-Circulating Line Cleaning Pump 300' & Over

LINE CLEANING JUMPER

Part Number	Description
CP101650-1	1 ft Line Cleaning Jumper w/ Fittings
CP101650-2	2 ft Line Cleaning Jumper w/ Fittings

CLEANING KIT

Part Number	Description
CP151040-KIT	1 Quart Cleaning Kit w/ Wrench, Brush & BLC

DIP TUBES

Part Number	Description
CP151068	5 Litre Dip Tube
CP151069	15 Litre Dip Tube
CP151070	30 Litre Dip Tube



PLASTIC CLEANING BOTTLES

Part Number	Description
CP151040	1 Quart Cleaning Bottle with Metal Pump
CP151054	5 Litre Cleaning Bottle
CP151055	15 Litre Cleaning Bottle
CP151056	30 Litre Cleaning Bottle



BOTTLE CAPS

Part Number	Description
CP151060	"D" System Cap
CP151061	"G" System Cap
CP151062	"U" System Cap
CP151063	"S" System Cap
CP151064	"A" System Cap
CP151065	"M" System Cap



STAINLESS STEEL CLEANING CANS

Part Number	Description
CP150980	9L 2 Head SS Cleaning Can with 2 "D" System Valves
CP150984	9L 2 Head SS Cleaning Can with "D" and "U" System Valves
CP150985	9L 2 Head SS Cleaning Can with "A" and "S" System Valves
CP151031	18L SS Cleaning Can with 4 "D" System Valves
CP151011	18L SS Cleaning Can with 2 "D" and 2 "U" System Valves
CP151012	18L SS Cleaning Can with 3 "D" and 1-"S" System Valves

Custom configurations available: choose from "A", "D", "G", "M", "S" or "U" valves.

DIRECT DRAW BEER DISPENSERS

VALUE LINE KEGERATORS

Part Number	Description
RE901032	1T Black Kegerator Less Tapping Kit
RE901032-X2	2T Black Kegerator Less Tapping Kit
RE901035	1T Black Kegerator w/ Tapping Kit
RE901037	2T Black Kegerator w/ Tapping Kit



VALUE LINE KEGERATOR TAPPING KIT INCLUDES:

- 5 lb Aluminum CO₂ Cylinder
- "D" System Keg Coupler
- CO₂ Regulator
- Cleaning Kit



KEG FRIDGE CLEANING KIT
CP151040-KIT



RE901035



RE901037-3BR

BRANDED KEGERATORS

Part Number	Description
RE901035-BR	Branded Door on 1T Kegerator w/ Tapping Kit
RE901035-3BR	Branded Door & Sides on 1T Kegerator w/ Tapping Kit
RE901037-BR	Branded Door on 2T Kegerator w/ Tapping Kit
RE901037-3BR	Branded Door & Sides on 2T Kegerator w/ Tapping Kit



RE801012-CO2

DIRECT DRAW TAPPING KITS

Part Number	Description
RE801012-CO2	CO2 1T Tapping Kit (KC)
RE801014-CO2	CO2 2T Tapping Kit (KC)
RE801015-CO2	CO2 3T Tapping Kit (KC)
RE801016-CO2	CO2 4T Tapping Kit (KC)



RE801014-CO2



RE801015-CO2

Part Number	Description
RE801012-N2	N2 1T Tapping Kit (KC)
RE801014-N2	N2 2T Tapping Kit (KC)
RE801015-N2	N2 3T Tapping Kit (KC)
RE801016-N2	N2 4T Tapping Kit (KC)

★ KEG COUPLERS SOLD SEPARATELY



RE801016-CO2

DIRECT DRAW BEER DISPENSERS

CONTINENTAL DIRECT DRAWS



REX00024
Shown with optional BB101402



REX00024-BR
Shown with optional BB103502-C



Part Number	Description	Dimensions W" x H" x D"
REX00024	KC24 1 DR - No Tower	24" x 38 1/2" x 31 1/8"
REX00050	KC50 2 DR - No Towers	50" x 36 3/4" x 27"
REX00059	KC59 2 DR - No Towers	59" x 36 3/4" x 27"
REX00069	KC69 2 DR - No Towers	69" x 36 3/4" x 27"
REX00079	KC79 3 DR - No Towers	79" x 36 3/4" x 27"
REX00090	KC90 3 DR - No Towers	90" x 36 3/4" x 27"

CONTINENTAL DIRECT DRAW BEER DISPENSERS ARE SOLD WITHOUT TOWERS. TO COMPLETE YOUR DIRECT DRAW, ADD THE TOWER CONFIGURATION(S) FROM THE TABLE BELOW.

AIR TOWERS



REX00090
Shown with optional BB101402

Part Number	Description
BB101402	1T PSS 3" Column - w/ Tap
BB101406	2T PSS 3" Column - w/ Taps
BB101419	3T PSS 3" Column - w/ Taps
BB102010-03	3T BSS T-Tower - No Taps
BB102010-04	4T BSS T-Tower - No Taps
BB102010-05	5T BSS T-Tower - No Taps
BB102010-06	6T BSS T-Tower - No Taps



REX00059
Shown with optional BB101402



BB101402



BB101406



BB101419



BB102010-06



TAPS SOLD SEPARATELY

★ TAP HANDLES NOT INCLUDED ON TOWERS

KEG COUPLERS



BB100990



BB100995



BB101002B-TS



BB101001B-TS



BB101000B-TS

Part Number	Description
BB100990	TOF "D" System Keg Coupler
BB100992SS	TOF "D" System Keg Coupler w/ 304SS Probe
BB100995	TOF "S" System Keg Coupler
BB100997SS	TOF "S" System Keg Coupler w/ 304SS Probe
BB101002B-TS	TOF "A" System Keg Coupler w/ 304SS Probe
BB101000B-TS	TOF "G" System Keg Coupler w/ 304SS Probe
BB1010001B-TS	TOF "U" System Keg Coupler w/ 304SS Probe

BAR BACK COOLERS

STANDARD MODELS

Part Number	Doors	Description	Width	Height	Depth
RE607024	1	Back Bar with Black Exterior and SS Top	24"	38 1/2"	31 1/8"
RE607050	2	Back Bar with Black Exterior and SS Top	50"	36 3/4"	27"
RE607059	2	Back Bar with Black Exterior and SS Top	59"	36 3/4"	27"
RE607069	2	Back Bar with Black Exterior and SS Top	69"	36 3/4"	27"
RE607079	3	Back Bar with Black Exterior and SS Top	79"	36 3/4"	27"
RE607090	3	Back Bar with Black Exterior and SS Top	90"	36 3/4"	27"



RE607069



RE607024

STANDARD MODELS WITH GLASS DOORS

Part Number	Doors	Description	Width	Height	Depth
RE607024-GD	1	Back Bar with Black Exterior and SS Top	24"	38 1/2"	31 1/8"
RE607050-GD	2	Back Bar with Black Exterior and SS Top	50"	36 3/4"	27"
RE607059-GD	2	Back Bar with Black Exterior and SS Top	59"	36 3/4"	27"
RE607069-GD	2	Back Bar with Black Exterior and SS Top	69"	36 3/4"	27"
RE607079-GD	3	Back Bar with Black Exterior and SS Top	79"	36 3/4"	27"
RE607090-GD	3	Back Bar with Black Exterior and SS Top	90"	36 3/4"	27"



RE607059-GD



RE607024-GD

STAINLESS STEEL MODELS

Part Number	Doors	Description	Width	Height	Depth
RE607024SS	1	Back Bar with SS Exterior and SS Top	24"	38 1/2"	31 1/8"
RE607050SS	2	Back Bar with SS Exterior and SS Top	50"	36 3/4"	27"
RE607059SS	2	Back Bar with SS Exterior and SS Top	59"	36 3/4"	27"
RE607069SS	2	Back Bar with SS Exterior and SS Top	69"	36 3/4"	27"
RE607079SS	3	Back Bar with SS Exterior and SS Top	79"	36 3/4"	27"
RE607090SS	3	Back Bar with SS Exterior and SS Top	90"	36 3/4"	27"



RE607079-GD



RE607024SS

CONVERT A BACK BAR TO A DIRECT DRAW

Part Number	Description
BB800005	13cfm Blower
BB800007	12cfm Blower with Shroud
BB800035	12/13cfm Blower Mounting Bracket
BB800036	Hardware to Mount Blower to Bracket
BB800050	1" x 6' Reinforced Air Hose

BB800007



BB800035



RE607050SS



RE607059SS



RE607090SS



RE607079SS



RE607069SS



RE901311



RE901313-BR

RECHARGEABLE COLD MERCHANDISERS

Part Number	Description
RE901311	Round Merchandiser - 115V
RE901311-BR	Branded Round Merchandiser - 115V
RE901313	Rectangular Merchandiser - 115V
RE901313-BR	Branded Rectangular Merchandiser - 115V

RECHARGEABLE COLD MERCHANDISERS WILL MAINTAIN AN AVERAGE 35-40°F DRINK TEMPERATURE IN A 90°F ENVIRONMENT FOR 12 HOURS WITHOUT POWER!



RE901357



RE901361-BR

COUNTERTOP GLASS DOOR MERCHANDISERS

Part Number	Description	Height
RE901357	Cooler holds 60 - 12 oz cans	30"
RE901357-BR	Branded RE901357	30"
RE901361	Cooler holds 55 - 12 oz cans	27 ½"
RE901361-BR	Branded RE901361	27 ½"
RE901371	Cooler holds 84 - 12 oz cans	36 ¼"
RE901371-BR	Branded RE901371	36 ¼"
RE901373	Cooler holds 120 - 12 oz cans	36 ¼"
RE901373-BR	Branded RE901373	36 ¼"



RE901375



RE901377-BR

UPRIGHT GLASS DOOR MERCHANDISERS

Part Number	Description	Height
RE901375	Cooler holds 210 - 12 oz cans	63"
RE901375-BR	Branded RE901375	63"
RE901377	Cooler holds 210 - 12 oz cans	63"
RE901377-BR	Branded RE901377	63"
RE901388	Cooler holds 384 - 12 oz cans	63"
RE901388-BR	Branded RE901388	63"
RE901391	Cooler holds 730 - 12 oz cans	79"
RE901391-BR	Branded RE901391	79"



RE901388



RE901388-BR



RE901391



RE901391-BR

MATERIAL HANDLING

HAND TRUCKS

Part Number	Description
MLHT111AM815C5	General Purpose Hand Truck
MLHT111HM815	General Purpose Hand Truck
MLHT515AUM1010C5	Keg Moving Hand Truck with Vertical Loop Handle and 10" Microcellular Foam Wheels
MLHT515AM815C5	Economy Keg Moving Hand Truck with Basic Loop Handle "U" Brace and 8" Rubber Wheels
MLHT515AUM1030C5	Keg Moving Hand Truck with Vertical Loop Handle and 10" Non-Marking Rubber Wheels
MLHT530UM1010C5	Keg Moving Hand Truck with Double Grip Handle and 10" Microcellular Foam Wheels
MLHT515AUM1060C5	Keg Moving Hand Truck with Vertical Loop Handle and 10" Pneumatic Wheels



MLHT111AM815C5



MLHT515AUM1060C5

FOLDING HAND TRUCKS

Part Number	Description
ML-F19-E1-815-LFN	Folding Hand Truck with Straight Back Frame Great for Case or Boxed Product Delivery
ML-F19-E1-830-FKEG	Folding Hand Truck with Curved Back Frame Great for Keg or Round Container Delivery



ML-F19-E1-815-LFN



ML-F19-E1-830-FKEG

GEMINI JR. CONVERTIBLE HAND TRUCK

Part Number	Description
MLGJR-1010	GMK16UAC Gemini Jr. Convertible Hand Truck
MLGJR-1030	GMK16UAB Gemini Jr. Convertible Hand Truck
MLGJR-1060	GMK16UA4 Gemini Jr. Convertible Hand Truck
MLGSR-1010	GMK81UAC Gemini Sr. Convertible Hand Truck
MLGSR-1030	GMK81UAB Gemini Sr. Convertible Hand Truck
MLGSR-1060	GMK81UA4 Gemini Sr. Convertible Hand Truck

Choose from these parts to design your own hand truck:



Design Your Own Hand Truck!



MLGSR-1010



MLGJR-1060





MLHT128-HM5-1060-BW

BOTTLED WATER TRUCKS

Part Number	Description
MLHT128-HM5-1060-BW	Five-Bottle Tray Truck

POWERED STAIR CLIMBER

Part Number	Description
ML-CLK170EGS4	Powered Stair Climber



ML-CLK170EGS4

CURB RAMPS

Part Number	Description
MLCR-PKR220	Yellow Curb Ramp
MLCR-PKR221	Red Curb Ramp
MLCR-PKR222	Blue Curb Ramp



MLCR-PKR220



MLCR-PKR221



MLCR-PKR222

KEG BUMPERS

Part Number	Description
BB702745	18" x 18" Keg Bumper
BB702750	24" x 24" Keg Bumper



BB702745

KEG JACKETS & WRAP

Part Number	Description
BB702710	20L Insulated Keg Jacket
BB702718	58L Insulated Keg Jacket
BB702785	4 Keg Insulated Wrap



BB702718

FLOJET BIB PUMPS

FLOJET BIB PUMPS

Part Number	Description
MP555000	T-5000 Gas Operated Beverage Pump
MP555020	G56 Syrup Pump
MP555021	G58 Juice Pump
MP555036-14	Bevjet II LF Electric Pump - 115V
MP555010	2125 Electric Pump - 115V



MP555000



MP555010



MP555021



MP555036-14

FLOJET BIB PUMP FITTINGS: PRODUCT

Part Number	Description
MP555001	SS 1/4" Straight Hose Barb
MP555002	SS 3/8" Straight Hose Barb Product Inlet & Outlet T-5000 / G55 / G58
MP555009	SS 1/4" Elbow Hose Barb Product Inlet & Outlet T-5000 / G55 / G58
MP555011	SS 3/8" Elbow Hose Barb Product Inlet & Outlet T-5000 / G55 / G58
MP555014	Plastic 3/8" - 1/2" Straight Hose Barb Product Inlet & Outlet G56 / K56
MP555016	SS 1/2" Straight Hose Barb Product Inlet & Outlet T-5000 / G55 / G58
MP555014-L	Plastic 3/8" - 1/2" Elbow Hose Barb Product Inlet & Outlet G56/K56



MP555001



MP555009



MP555002



MP555011

FLOJET BIB PUMP FITTINGS: GAS

Part Number	Description
MP555003	Brass 1/4" Elbow Hose Barb Inlet with Shut-off T-5000
MP555004	Brass 1/4" "T" Hose Barb Inlet with Shut-off T-5000
MP555008	Brass 1/4" Straight Hose Barb Inlet with Shut-off T-5000
MP555024	Brass 1/4" Elbow Hose Barb Inlet with Shut-off G-Series
MP555025	Brass 1/4" "T" Hose Barb Inlet with Shut-off G-Series



MP555003



MP555004

FLOJET PUMP ACCESSORIES

Part Number	Description
MP555012	Transfer Valve - Regular
MP555012V	Transfer Valve - High Altitude
MP555015	Strainer - 3/8" Barb Inlet, 3/8" Barb Outlet, 40 Mesh Stainless Steel Screen
MP555017	50PSI Water Regulator with 3/8" Barbed Fittings
MP555018	30PSI Water Regulator with 3/8" Barbed Fittings



MP555012



MP555015



SHURFLO BIB PUMP

Part Number	Description
MP557000	Gas Operated Syrup Pump

SHURFLO BIB PUMP FITTINGS: GAS

Part Number	Description
MP557008	Shurflo Yellow Gas "T"
MP557009	Shurflo Yellow Gas "L"
MP557013	Shurflo Brass 1/4" Gas "T"

SHURFLO BIB PUMP FITTINGS: PRODUCT

Part Number	Description
MP557005	Shurflo SS 1/4" Syrup Elbow
MP557006	Shurflo SS 3/8" Syrup Elbow
MP557007	Shurflo Plastic 3/8" Syrup Inlet

BIB PUMP MOUNTING BOARDS

Part Number	Description
MP559022	2 Pump Mounting Board
MP559023	3 Pump Mounting Board

CARBONATORS

Part Number	Description
MP556105	Standard Flow Carbonator ASSE 1022 - 115V
MP556108	McCann's Big Mac Carbonator ASSE 1022 - 115V
SB596110	Lancer Turbo Carbonator ASSE Check Valve - 115V

MCCANN CARBONATOR PARTS

Part Number	Description
MP556130	McCann's Carbonator Backflow Preventer (ASSE 1022)
MP556131	McCann's Probe Electronics 115V
MP556132	McCann's Probe Conversion Kit 115V
MP556134	McCann's Probe & Float Assembly 115V
MP556135	McCann's 3/8" MFL Double Check Valve
MP556136	McCann's 1/4" MFL Single Check Valve
MP556138	McCann's 180 PSI Pressure Relief Valve
MP556142	McCann's Carbonator ASSE 1022 Repair Kit

CARBONATOR PARTS KITS - INCLUDES NUTS, STEMS AND WASHERS

Part Number	Description
MP556121	McCann's Standard Carbonator Fittings Kit
MP556122	McCann's Big Mac Carbonator Fittings Kit

BIB RACKING

CBS offers complete assembly of BIB Racks. Save time, money and frustration by buying BIB Racks fully assembled and ready to install. Send us your custom configuration and we will do the rest. Drop shipments and special orders are welcome.



BIB RACKS

Part Number	Description
MP558998	1 Box Wide Incline BIB Rack
MP559000	2 Box Wide Incline BIB Rack
MP559000C	2 Box Wide Flat BIB Rack
MP559003	3 Box Wide Incline BIB Rack



BIB TOP SHELVES

Part Number	Description
MP559010	1 Box Wide BIB Top Shelf
MP559011	2 Box Wide BIB Top Shelf
MP559012	3 Box Wide BIB Top Shelf



BIB CONNECTORS

Part Number	Description
MP550002	Liqui-Box QCD II Bag-In-Box Connector
MP550008	Green Pepsi Screw On Bag-In-Box Connector
MP550010	CC Bag-In-Box Connector
MP550022	Tomlinson Bag-In-Box Faucet



POST MIX PRIMARY REGULATOR KITS - INCLUDES REGULATOR, 36" FLEXHOSE AND CO₂ COUPLING KIT

Part Number	Description
CO883160CW-KIT	C. 2P(100/160) Primary Wall Mount Regulator Kit
CO883160TW-KIT	TR. 2P(100/160) Primary Wall Mount Regulator Kit



POST MIX CO₂ PRIMARY REGULATORS

Part Number	Description
CO882160CB	C. 1P(160) Primary Tank Mount Regulator
CO882160W	C. 1P(160) Primary Wall Mount Regulator
CO883160C	C. 2P(100/160) Primary Tank Mount Regulator
CO883160T	TR. 2P(100/160) Primary Tank Mount Regulator
CO883160CW	C. 2P(100/160) Primary Wall Mount Regulator
CO883160TW	TR. 2P(100/160) Primary Wall Mount Regulator

SECONDARY REGULATORS - WITH 1/4" BARB FITTINGS

Part Number	Description
CO881106C	C. 1P(100) Secondary Wall Mount Regulator
CO881106T	TR. 1P(100) Secondary Wall Mount Regulator
CO881166C	C. 1P(160) Secondary Wall Mount Regulator
CO881166T	TR. 1P(160) Secondary Wall Mount Regulator

SECONDARY REGULATORS - PLUG & 1/4" BARB FITTING

Part Number	Description
CO881105C	C. 1P(100) Secondary Wall Mount Regulator
CO881105T	TR. 1P(100) Secondary Wall Mount Regulator
CO881165C	C. 1P(160) Secondary Wall Mount Regulator
CO881165T	TR. 1P(160) Secondary Wall Mount Regulator

CO₂ CHANGEOVER VALVES

Part Number	Description
CO898812	CO ₂ Changeover Valve
CO898812-P	CO ₂ Changeover Valve-minus the check valves

CO₂ - N₂ PRIMARY REGULATOR WRENCH

Part Number	Description
CO898804	Primary Regulator Wrench

FOUNTAIN FITTINGS NUTS, STEMS AND WASHERS

Part Number	Description
MP550003	1/4" White Flare Washer
MP550004	3/8" Black Flare Washer
MP550005	15/16" Red Flare Washer
SF147265	SS 1/4" Barb (fits 1/4" Swivel Nut)
SF147375	SS 1/4" Barb (fits 3/8" Swivel Nut)
SF149265	1/4" Swivel Nut
SF387375	SS 3/8" Barb (fits 3/8" Swivel Nut)
SF389375	3/8" Swivel Nut

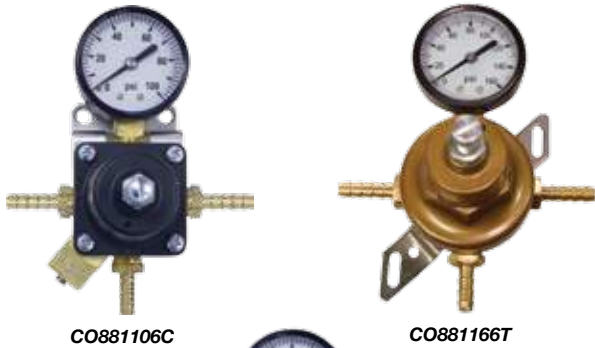
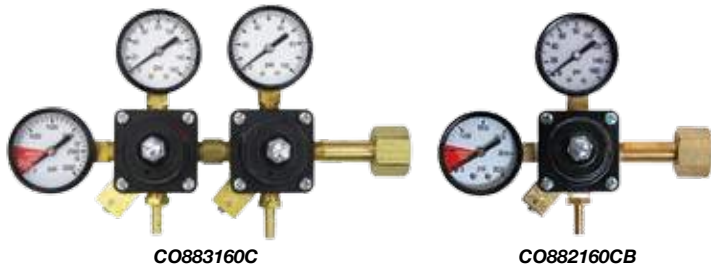

BIB PRODUCTS

CO₂ FLEXHOSE ASSEMBLIES

Part Number	Description
CO883600	36" CO ₂ Flexhose
CO887200	72" CO ₂ Flexhose



CO883600

WATER REGULATORS AND BACKFLOW PREVENTERS

Part Number	Description
MP555017	Flojet Water Regulator - Preset at 50 PSI
MP555018	Flojet Water Regulator - Preset at 30 PSI
MP551721	Chudnow Backflow Preventer - 3/8" MFL x 3/8" MFL
MP551722	Watt's 9BD Backflow Preventer - 3/8" MFL x 3/8" MFL
MP551730	Watt's Water Regulator - 3 to 50 PSI
MP551733	Watt's Water Regulator - 10 to 125 PSI



MP555017



MP551730



MP551721



MP551722

MOTORS, PUMPS AND ACCESSORIES

Part Number	Description
MP000450	V-Band Clamp
MP000479	Procon 100GPH Brass Pump with Strainer
MP000480	50GPH SS Pump
MP000510	100GPH SS Pump
MP551740	1/3 HP/1725 RPM Motor -115V



MP000450



MP000479



MP551740

COLD PLATE FITTINGS

Part Number	Description
CL000225	SS 1/4" MFL x 1/4" Barb
CL000250	SS 5/16" MFL x 1/4" Barb
CL000375	SS 5/16" MFL x 3/8" Barb
SF147717	SS 3/8" MFL x 1/4" MFL Union
SF147719	SS 5/16" MFL x 5/16" MFL
SF147720	SS 1/4" MFL x 1/4" MFL Union
SF147720P	Plastic 1/4" MFL x 1/4" MFL
SF147721	SS 1/4" MFL x 5/16" MFL



CL000250

ALUMINIUM COLD PLATES

Part Number	Description
CL000099	1 Channel 8" x 12"
CL000100	2 Channel 8" x 12"
CL000300	3 Channel 8" x 14"
CL000400	4 Channel 8" x 14"
CL000500	5 Channel 8" x 14"
CL000600	6 Channel 8" x 14"
CL000700	7 Channel 8" x 14"



CL000100

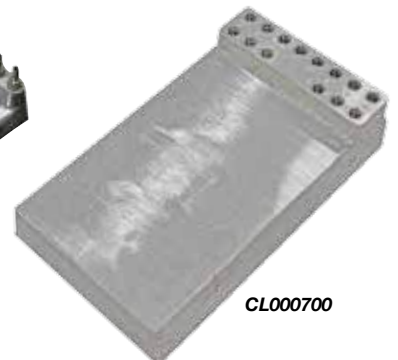

CL000700



MP555093

FLOJET ELECTRIC WATER BOOSTER PUMP

Part Number	Description
MP555093	Electric Water Booster Pump - 115V

FLOJET WATER BOOSTER SYSTEMS

Part Number	Description
MP555085	2820 Water Booster System 1.5 GPM
MP555087	2840 Water Booster System 3.5 GPM
MP555090	K56 Water Booster System 4 GPM



MP555085



MP555087



MP555090



BB900219



BB900214



BB900205

FLASH COOLERS - COOL WATER, SYRUPS OR JUICES

Part Number	Description
BB900205	Vin Service "Flat" Flash Cooler w/2-SS Product Lines (9m +8m)-115V-25L/Hour
BB900214	Vin Service HE60 Flash Cooler w/4-SS Product Lines (6m,6m,10m,7m) -115V-60L/Hour
BB900219	Vin Service HE90V Flash Cooler w/4-SS Product Lines (8m,9m,14m,12m)-115V-90L/Hour
BB900222	Vin Service HE120V Flash Cooler w/4-SS Product Lines (22m, 21m, 19m, 17m) -115V-120L/Hour
BB900224	Vin Service HE120V Flash Cooler w/6-SS Product Lines (21m, 20m, 17m, 14m, 13m, 13m) 115V-120L/Hour



BB900222



BB900224

MEASURING DEVICES

Part Number	Description
MP000100	Refractometer 0-30
MP551713	Brix Cup



MP000100



MP551713

BAR GUNS

SCHROEDER AMERICA BAR GUNS

Part Number	Description
MP883701	1 Button Energy Drink Gun
MP883702	2 Button Energy Drink Gun
MP883760	6 Product Juice Gun
MP883768	8 Product Juice Gun
MP883773	8 Button Gun (6+0)
MP883778	10 Button Combo Gun (5+3)
MP883783	12 Button Combo Gun (5+5)
MP883793	14 Button Combo Gun (6+6)



SCHROEDER AMERICA BAR GUN PARTS

Part Number	Description
MP883500	Sanitary Holster - 675-0017
MP883502	Wire Drip Cup Assembly - 645-0156
MP883502-CUP	Rubber Insert Cup - Wire Holder - 315-0008
MP883510	Syrup Separator - 316-0004
MP883512	Water Splitter Assembly - 631-0039
MP883514	Parts Kit - 675-0019
MP883525	Black Nozzle - 265-0194
MP883525-01	Nozzle O'Ring - 210-0006
MP553831-SA	Valve Stem - 265-0200



SCHROEDER AMERICA BAR GUN FITTINGS

Part Number	Description
MP883515	1/4" SS Barb - 625-0004
MP883516	3/8" SS Barb - 625-0005
MP883517	1/4" SS 90° Barb - 625-0013
MP883518	3/8" SS 90° Barb - 625-0011
MP883519	1/4" SS 45° Barb - 625-0014
MP883520	3/8" SS 45° Barb - 625-0012



SCHROEDER AMERICA FLOW CONTROL BAR GUNS





WUNDERBAR BAR GUN FITTINGS

Part Number	Description
MP553807	3/8" SS Barb - PM10-11
MP553808	3/8" SS Barb Long - PM10-12
MP553816	1/4" SS Barb Long - PM10-47
MP553816S	1/4" SS Barb - PM10-9

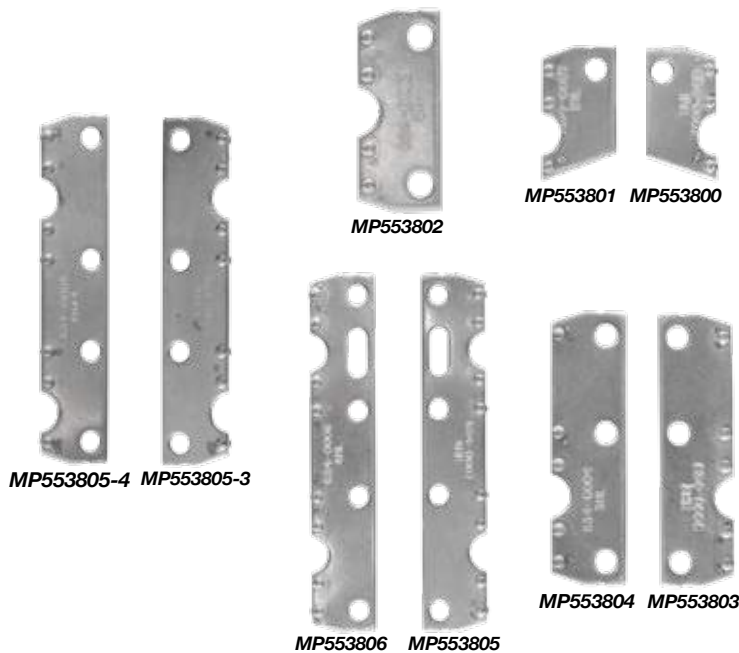

WUNDERBAR BAR GUNS

Part Number	Description
MP883880	6 Product Juice Gun
MP883882	8 Product Juice Gun
MP883888	8 Button Gun (6+0)
MP883890	10 Button Gun (5+3)
MP883893	12 Button Gun (5+5)
MP883894	12 Button Gun (6+4)
MP883895	14 Button Gun (7+5)

WUNDERBAR BAR GUN PARTS

Part Number	Description
MP553809	Twist Lock Nozzle (S2.5,S3) - PH10-94
MP553810	Syrup Separator (S2.5) - PH10-83
MP553811	Parts Kit - PM10-38
MP553822	Drip Cup - PM10-41
MP553822KIT	Hose Hanger Kit - PM10-43
MP553921	Tube Seal O'Ring - PH10-19

BAR GUN BUTTERFLY PLATES

Part Number	Description
MP553800	1HR Butterfly Plate
MP553801	1HL Butterfly Plate
MP553802	2H Butterfly Plate
MP553803	3HR Butterfly Plate
MP553804	3HL Butterfly Plate
MP553805	4HR Butterfly Plate
MP553806	4HL Butterfly Plate
MP553805-3	4H #3 Butterfly Plate
MP553805-4	4H #4 Butterfly Plate
MP553805-6	4H #6 Butterfly Plate

BAR GUN BUTTONS

Part Number	Description
MP553832	Soda Button Cap
MP553833	Water Button Cap
MP553843	White "M" Button Cap
MP553844	Green "L" Button Cap
MP553845	White "C" Button Cap
MP553846	White "L" Button Cap
MP553847	White "T" Button Cap
MP553848	White "Q" Button Cap
MP553849	White "G" Button Cap
MP553850	Red "C" Button Cap
MP553851	Red "T" Button Cap

Part Number	Description
MP553852	Orange "O" Button Cap
MP553853	Brown "B" Button Cap
MP553854	Yellow "S" Button Cap
MP553855	Pink "G" Button Cap
MP553856	White "D" Button Cap
MP553876	Red "CRAN" Button Cap
MP553877	Yellow "P" Button Cap
MP553882	Brown "RBEER" Button Cap
MP553911	White "O" Button Cap
MP553917	Brown "TEA" Button Cap
MP553919	Green "APPLE" Button Cap
MP553920	Green "GINGER" Button Cap



FOUNTAIN

POST MIX TEA DISPENSERS

Part Number	Description
SB220011	Branded 1P Oval Post Mix Tea Urn
SB220022	Branded 2P Square Post Mix Tea Urn



SB220011

POST MIX TOWERS

Part Number	Description
SB009301	1P Lit Post Mix Tower - 15"H
SB009302	2P Lit Post Mix Tower - 15"H



SB009302



SB500202

UNICORN POST MIX TOWER

Part Number	Description
SB500202	4P Unicorn
SB500210	4P Unicorn with Portion Control

POST MIX SPARTAN COUNTERTOP

Part Number	Description
SB500122	2P Spartan with Carbonator
SB500123	3P Spartan with Carbonator
SB500124	4P Spartan with Carbonator



SB500124

POST MIX TOWERS

Part Number	Description
SB500650	2P Post-Mix Tower
SB500675	6P Post-Mix Tower



SB500650



SB500675



SB300193



SB300115

DROP-IN ICE COOLED DISPENSERS

Part Number	Description
SB300115	6P 15" X 22" Drop-in
SB300193	6P 23" x 23" Drop-in

ICE-BEVERAGE DISPENSERS

Part Number	Description
SB300520	6P 22" Ice-Bev Dispenser
SB300528	8P 25" Ice-Bev Dispenser
SB300534	10P 30" Ice-Bev Dispenser
SB300545	12P 44" Ice-Bev Dispenser



SB300520



SB300528



SB300534



SB300545

COUNTERTOP ELECTRIC JUICE DISPENSERS

Part Number	Description
SB701460	4P Electric Juice Dispenser
SB701500	6P Electric Juice Dispenser



SB701460



SB701500

BUNDLED TUBING

Part Number	Description
BT060000-100	6L - 6 x .265" ID Poly - 100'
BT060000-500	6L - 6 x .265" ID Poly - 500'
BT090000	9L - 9 x .265" ID Poly - 100'
BT100375	10L - 10 x .375" ID Barrier - 100'
BT120375	12L - 12 x .375" ID Barrier - 100'
BT141165	14L - 10 x .265" ID & 4 x .375" ID Barrier - 100'



BT141165

BT060000-100

TUBING

TUBING

Part Number	Description	Color	Length
BT143900	1/4" ID x 3/8" OD Barrier	Natural	500'
BT144500	1/4" ID x 1/2" OD PVC Braid	Clear	100'
BT144600	.265" (1/4") x .457" Poly Braid	White	500'
BT384900	5/16" ID x 7/16" OD Barrier	Natural	500'
BT385100	3/8" ID x 1/2" OD Barrier	Natural	500'
BT385800	5/16" ID x 9/16" OD PVC Braid	Clear	100'
BT385807	3/8" ID x 5/8" OD PVC Braid	Clear	100'
BT385809	3/8" ID x 5/8" OD Vinyl BIB	Clear	100'
BT385815	5/16" ID x 7/16" OD PVC	Clear	100'
BT386350	.375" (3/8") x .593" Poly Braid	White	300'
BT500650	1/2" ID x 3/4" OD PVC	Clear	100'
BT500675	3/4" ID x 1" OD PVC	Clear	100'
BT600740	1/2" ID x 3/4" OD PVC	Gray	100'
BT600750	3/4" ID x 1" OD PVC	Gray	100'
BT601000	1" ID x 1 1/4" OD PVC	Gray	100'



CABLE TIES

Part Number	Description
MP000770	7" Natural
MP000771	11" Natural
MP000772	15" Natural
MP000773	7" Natural with Screw Mount
MP000774	11" Natural with Screw Mount
MP000775	15" Natural with Screw Mount



TUBING CLAMPS

Part Number	Description
MP000750	3/8" Cable Clamp - 100/bag
MP000753	1/2" Cable Clamp - 100/bag
MP000756	5/16" Cable Clamp - 100/bag



TUBE CUTTING TOOLS

Part Number	Description
MP559950	Multi Cutter
MP559960	Jumbo Bundle Cutter
MP559970	Pocket Hose Cutter



TRANSFER TANKS



Part Number	Description
MP099900	A.E.B Ball Lock 2.5G SS Tank
MP099910	A.E.B Ball Lock 5G SS Tank

TANK REPLACEMENT PARTS



Part Number	Description
MP099950	Transfer Tank Lid W/Safety
MP099952	Transfer Tank PRV
MP099955	Tank Lid O'Ring
MP099962	Pin Lock Post O'Ring
MP099965	Ball Lock Post O'Ring
MP099975	Poppet Valve
MP099981	Tank Inlet Plug Assembly - Gas
MP099983	Tank Outlet Plug Assembly - Liquid

TANK FITTINGS



Part Number	Description
MP100099	Pin Lock with 1/4" Barb-Gas
MP100000	Pin Lock with 1/4" Barb-Liquid
MP110001	Ball Lock with 1/4" Barb-Gas
MP110002	Ball Lock with 1/4" Barb-Liquid
MP110003	Ball Lock with 1/4" MFL-Gas
MP110004	Ball Lock with 1/4" MFL-Liquid

WATER TOWERS

MONGOOSE AIR

Part Number	Taps	Finish	Cooling	Drip Tray
WF107140CE	1	Chrome	Air	10"
WF107150CE	2	Chrome	Air	10"
WF107160CE	3	Chrome	Air	12"
WF107143CE	1	White	Air	10"
WF107153CE	2	White	Air	10"
WF107163CE	3	White	Air	12"



WF107140CE



WF107153CE



WF107160CE

MONGOOSE

MONGOOSE GLYCOL

Part Number	Taps	Finish	Cooling	Drip Tray
WF107140CE-CK	1	Chrome	Glycol	10"
WF107150CE-CK	2	Chrome	Glycol	10"
WF107160CE-CK	3	Chrome	Glycol	12"
WF107143CE-CK	1	White	Glycol	10"
WF107153CE-CK	2	White	Glycol	10"
WF107163CE-CK	3	White	Glycol	12"



WF107163CE-CK

SEXY AIR

Part Number	Taps	Finish	Cooling	Drip Tray
WF107091CE	1	Chrome	Air	10"
WF107092CE	2	Chrome	Air	10"
WF107093CE	3	Chrome	Air	12"



WF107091CE



WF107092CE-CK



SEXY GLYCOL

Part Number	Taps	Finish	Cooling	Drip Tray
WF107091CE-CK	1	Chrome	Glycol	10"
WF107092CE-CK	2	Chrome	Glycol	10"
WF107093CE-CK	3	Chrome	Glycol	12"

★ TAP HANDLES NOT INCLUDED

★ TAPS SOLD SEPARATELY

ALL TOWERS
ON THIS PAGE



SEXY

MONGOOSE AIR WITH MEDALLION HOLDER

Part Number	Taps	Finish	Cooling	Drip Tray
WF107240CE	1	Chrome	Air	10"
WF107250CE	2	Chrome	Air	10"
WF107260CE	3	Chrome	Air	12"
WF107243CE	1	White	Air	10"
WF107253CE	2	White	Air	10"
WF107263CE	3	White	Air	12"

MONGOOSE

MONGOOSE GLYCOL WITH MEDALLION HOLDER

Part Number	Taps	Finish	Cooling	Drip Tray
WF107240CE-CK	1	Chrome	Glycol	10"
WF107250CE-CK	2	Chrome	Glycol	10"
WF107260CE-CK	3	Chrome	Glycol	12"
WF107243CE-CK	1	White	Glycol	10"
WF107253CE-CK	2	White	Glycol	10"
WF107263CE-CK	3	White	Glycol	12"

LIT SEXY AIR

Part Number	Taps	Finish	Cooling	Drip Tray
WF107095CE	1	Chrome	Air	10"
WF107096CE	2	Chrome	Air	10"
WF107097CE	3	Chrome	Air	12"

LIT SEXY GLYCOL

Part Number	Taps	Finish	Cooling	Drip Tray
WF107095CE-CK	1	Chrome	Glycol	10"
WF107096CE-CK	2	Chrome	Glycol	10"
WF107097CE-CK	3	Chrome	Glycol	12"

 MEDALLIONS & TAP HANDLES NOT INCLUDED
 TAPS SOLD SEPARATELY



WF107263CE



WF107250CE



WF107240CE-CK



WF107253CE-CK



WF107095CE



WF107096CE-CK

SEXY

ALL TOWERS ON THIS PAGE



WATER TOWERS

LUCKY AIR

Part Number	Taps	Finish	Cooling	Drip Tray
WF107121CE	1	Chrome	Air	10"
WF107122CE	2	Chrome	Air	10"
WF107123CE	3	Chrome	Air	12"

LUCKY GLYCOL

Part Number	Taps	Finish	Cooling	Drip Tray
WF107121CE-CK	1	Chrome	Glycol	10"
WF107122CE-CK	2	Chrome	Glycol	10"
WF107123CE-CK	3	Chrome	Glycol	12"

LIT LUCKY AIR

Part Number	Taps	Finish	Cooling	Drip Tray
WF107126CE	1	Chrome	Air	10"
WF107127CE	2	Chrome	Air	10"
WF107128CE	3	Chrome	Air	12"

LIT LUCKY GLYCOL

Part Number	Taps	Finish	Cooling	Drip Tray
WF107126CE-CK	1	Chrome	Glycol	10"
WF107127CE-CK	2	Chrome	Glycol	10"
WF107128CE-CK	3	Chrome	Glycol	12"

 TAP HANDLES NOT INCLUDED

 TAPS SOLD SEPARATELY



WF107121CE

WF107122CE-CK

WF107123CE

LUCKY



WF107126CE

WF107127CE

WF107128CE



XENIA TOWER

Part Number	Taps	Finish	Drip Tray
WF102070	Lever	3	10"
WF102080	Push Button	3	10"



XENIA

WF102070

WF102080



WF920210



WF920212



WF920214

80MM MEDALLIONS

Part Number	Description
WF920210	"Chilled"
WF920212	"Chilled Sparkling"
WF920214	"Ambient"

82MM MEDALLIONS

Part Number	Print
WF920220	"Chilled"
WF920222	"Chilled Sparkling"
WF920224	"Ambient"



WF920021



WF920025



WF920029



WF920001



WF920005



WF920009

TRAP-Z WATER TAP HANDLES

Part Number	Color	Print	Fitting
WF920021	White	"Chilled"	Chrome
WF920025	White	"Chilled Sparkling"	Chrome
WF920029	White	"Ambient"	Chrome

SHOTGUN 2.0 WATER TAP HANDLES

Part Number	Color	Print	Fitting
WF920001	White	"Chilled"	Chrome
WF920005	White	"Chilled Sparkling"	Chrome
WF920009	White	"Ambient"	Chrome



BB100301-B



BB100301-C



BB101260

TAP HANDLES

Part Number	Description
BB100301-B	Black Plastic Tap Handle
BB101301-C	Chrome Plastic Tap Handle
BB101260	Chrome Plated Brass Tap Handle

WATER PRODUCTS

STAINLESS STEEL DRIP TRAYS

Part Number	Description	Drain
BB700802	10 3/8" x 5 3/8" Drip Tray	X
BB700812	15" x 5 3/8" Drip Tray	X
BB701902	10 3/8" x 5 3/8" Drip Tray	✓
BB701908	12" x 5 3/8" Drip Tray	✓
BB701912	15" x 5 3/8" Drip Tray	✓



BB700802

FAUCETS

Part Number	Description
BB101198	316SS Flux Faucet
BB101231	304SS Euro Quix F/C Faucet With Shank



BB101231



BB101198

TAP HANDLES NOT INCLUDED

WATER ACCESSORIES

Part Number	Description
MP555017	Flojet Water Regulator - Preset at 50 PSI
MP555018	Flojet Water Regulator - Preset at 30 PSI
MP551060	Flow Restrictor
MP551721	Chudnow SS 3/8" MFL x 3/8" MFL
MP551722	Watts SS 9BD - 3/8" MFL x 3/8" MFL
MP551730	Watt's Water Regulator - 3 to 50 PSI
MP551731	Watt's Water Regulator Repair Kit



MP555017



MP551730



MP551722

CO₂ PRIMARY REGULATOR

Part Number	Description
CO882160CB	C. 1P(160) Primary Tank Mount Regulator



CO882160CB

ALUMINIUM COLD PLATES

Part Number	Description
CL000099	1 Channel 8" x 12"
CL000100	2 Channel 8" x 12"



CL000099



CL000100

CARBONATORS

Part Number	Description
MP556105	Standard Flow Carbonator ASSE 1022 - 115V
MP556108	McCann Big Mac Carbonator ASSE 1022-115V
SB596110	Lancer Turbo Carbonator ASSE Check Valve-115V



MP556105



MP556108

FLASH COOLERS - CHILL WATER TO THE POINT OF DISPENSE



BB900205



BB900214

Part Number	Description
BB900205	Vin Service "Flat" Flash Cooler w/2-SS Product Lines (9m +8m)-115V-25L/Hour
BB900214	Vin Service HE60 Flash Cooler w/4-SS Product Lines (6m,6m,10m,7m)-115V-60L/Hour
BB900219	Vin Service HE90V Flash Cooler w/4-SS Product Lines (8m,9m,14m,12m)-115V-90L/Hour
BB900222	Vin Service HE120V Flash Cooler w/4-SS Product Lines (22m, 21m, 19m, 17m)-115V-120L/Hour
BB900224	Vin Service HE120V Flash Cooler w/6-SS Product Lines (21m, 20m, 17m, 14m, 13m, 13m) 115V-120L/Hour



BB900219



BB900222



BB900224



WF565345

REMOTE WATER FLASH COOLER- CARBONATE & CHILL WATER TO THE POINT OF DISPENSE

Part Number	Description
WF565345	Horeca Remote Cooler with Built-In Carbonator and Pump - 70L/HR - 115V

ETL & ETL-S Certified



WF565315

REMOTE WATER FLASH COOLER- DRY REFRIGERATION FEATURE

Part Number	Description
WF565315	Spring Remote Cooler with Built-In Carbonator 20L/HR - 115V - Minimal maintenance as there is no water tank to maintain.



WF565060

COUNTERTOP WATER FLASH COOLER - CARBONATE & CHILL

Part Number	Description
WF565060	Crystal Countertop Chiller/Dispenser with Built-In Carbonator - 115V

ETL & ETL-S Certified



AETHER

Aether filters for drinking water, cold beverages, hot beverages, ice and food service equipment.



WF007820

WATER FILTER SYSTEMS WITH SEDIMENT PRE-FILTERS

Part Number	Description
WF007820	Twin Filter With Sediment Pre-Filter
WF007830	Triple Filter With Sediment Pre-Filter
WF007840	Quad Filter With Sediment Pre-Filter



WF007840

AETHER REPLACEMENT FILTERS - CARBON

Part Number	Description
WF007101	1 Micron Carbon Block - 14000 Gal
WF007105	5 Micron Carbon Block - 14000 Gal
WF007110	1 Micron Carbon Foam - 9000 Gal
WF007115	1 Micron Carbon Foam 18000 Gal



AETHER REPLACEMENT FILTERS - SCALE & SEDIMENT

Part Number	Description
WF007140	1 Micron Scale - 20,000 Gal
WF007145	1 Micron Scale - 30,000 Gal
WF007150	1 Micron Scale - 60,000 Gal
WF007185	1 Micron Sediment - 14,000 Gal



AETHER MANIFOLDS

Part Number	Description
WF007511	Single Stage With Gauge
WF007512	Double Stage With Gauge
WF007513	Triple Stage With Gauge
WF007514	Quad Stage With Gauge



WF007511



WF007512



WF007513



WF007514

WATER FILTER SYSTEM KITS

Part Number	Description
WF006375	3M HF60 Kit - Filter, Housing, Tubing & Fittings
WF006387	3M HF90 Kit - Filter, Housing, Tubing & Fittings



WF006530



WF006545



WF006250



WF006320



WF006310

WATER FILTER ACCESSORIES

Part Number	Description
WF006530	3M VH3 - 3/8" FNPT, Valve-In-Head
WF006545	3M VH3 - 3/8" FNPT, Valve-In-Head with Shroud and Plug
WF006550	3M VH3 - 3/8" FNPT, Valve-In-Head with Shroud and Gauge

REPLACEMENT WATER FILTERS

Part Number	Description
WF006250	6" In-Line Filter (10micron/750gal)
WF006253	3M 6" In-Line Filter (5micron/1500gal)
WF006310	3M HF60 Filter (0.2micron/35,000gal)
WF006320	3M HF90 Filter (0.2micron/54,000gal)

BOTTLED WATER DISPENSERS

Part Number	Description
MP555070	Flojet Single Inlet Bottled Water Dispenser - 115V
MP555070-2A	Flojet Dual Inlet Bottled Water Dispenser - 115V



MP555070

WATER BOOSTER PUMPS

Part Number	Description
MP555023	Flojet Gas Operated Water Booster Pump
MP555093	Duplex Electric Water Booster Pump - 115V



MP555093



MP555023

FLOJET WATER BOOSTER SYSTEMS

Part Number	Description
MP555085	2820 Water Booster System 1.5 GPM
MP555087	2840 Water Booster System 3.5 GPM
MP555090	K56 Water Booster System 4 GPM



MP555087



MP555090

WINE TOWERS



SEXY

Part Number	Taps	Finish	Cooling	Drip Tray
WW107091CA	1	Chrome	Air	10"
WW107091CA-CK	1	Chrome	Glycol	10"
WW107092CA	2	Chrome	Air	10"
WW107092CA-CK	2	Chrome	Glycol	10"
WW107093CA	3	Chrome	Air	12"
WW107093CA-CK	3	Chrome	Glycol	12"



WW107091CA



WW107092CA



WW107093CA

MONGOOSE

Part Number	Taps	Finish	Cooling	Drip Tray
WW107140CA	1	Chrome	Air	10"
WW107140CA-CK	1	Chrome	Glycol	10"
WW107150CA	2	Chrome	Air	10"
WW107150CA-CK	2	Chrome	Glycol	10"
WW107160CA	3	Chrome	Air	12"
WW107160CA-CK	3	Chrome	Glycol	12"



WW107140CA



WW107150CA



WW107160CA

LUCKY

Part Number	Taps	Finish	Cooling	Drip Tray
WW107121CA	1	Chrome	Air	10"
WW107121CA-CK	1	Chrome	Glycol	10"
WW107122CA	2	Chrome	Air	10"
WW107122CA-CK	2	Chrome	Glycol	10"
WW107123CA	3	Chrome	Air	12"
WW107123CA-CK	3	Chrome	Glycol	12"



WW107121CA



WW107122CA



WW107123CA

MINI MUSHROOM

Part Number	Taps	Finish	Cooling	Drip Tray
WW107373CA	3	Polished SS	Air	14" x 8"
WW107374CA	4	Polished SS	Air	14" x 8"
WW107375CA	5	Polished SS	Air	14" x 8"



WW107374CA

4" POLISHED SS COLUMNS

Part Number	Taps	Finish	Cooling	Drip Tray
WW101421CA	1	Polished SS	Air	14" x 8"
WW101422CA	2	Polished SS	Air	14" x 8"
WW101423CA	3	Polished SS	Air	14" x 8"
WW101424CA	4	Polished SS	Air	14" x 8"



WW101423CA



 TAP HANDLES & DRIP TRAYS NOT INCLUDED

 TAPS SOLD SEPARATELY



WW103122CC



WW103614A-04



SPACE MIZER

Part Number	Taps	Finish	Length	Cooling	Drip Tray
WW103614A-03	3	Brushed SS	14"	Air	15"
WW103614A-04	4	Brushed SS	14"	Air	15"
WW103620A-05	5	Brushed SS	20"	Air	20"
WW103620A-06	6	Brushed SS	20"	Air	20"
WW103626A-08	8	Brushed SS	26"	Air	24"
WW103632A-10	10	Brushed SS	32"	Air	30"
WW103638A-12	12	Brushed SS	38"	Air	36"

TAPS SOLD SEPARATELY

CLAMP-ON TOWERS TAPS INCLUDED

Part Number	Taps	Finish	Cooling	Drip Tray
WW103121CA	1	Polished SS	Air	5"
WW103122CA	2	Polished SS	Air	10"

TAP HANDLES NOT INCLUDED



CL106212L



CL106149X



CL000099

304SS COILS

Part Number	Description
CL106149X	50' 304SS Coil - 5" Dia.
CL106150L	50' 304SS Coil - Left - 9" Dia.
CL106150R	50' 304SS Coil - Right - 9" Dia.
CL106212L	120' 304SS Coil - Left - 9" Dia.
CL106212R	120' 304SS Coil - Right - 9" Dia.

ALUMINIUM COLD PLATES

Part Number	Description
CL000099	1 Channel 8" x 12"
CL000100	2 Channel 8" x 12"
CL000300	3 Channel 8" x 14"
CL000400	4 Channel 8" x 14"

FLASH COOLERS - CHILL WINE TO THE POINT OF DISPENSE

Part Number	Description
BB900205	Vin Service "Flat" Flash Cooler w/2-SS Product Lines (9m +8m) 115V-25L/Hour
BB900214	Vin Service HE60 Flash Cooler w/4-SS Product Lines (6m, 6m, 10m, 7m) 115V-60L/Hour

New and Innovative!

BB900217-W	Vin Service HE60 Wine Flash Cooler w/ 4 Product Lines (6m, 6m, 10m, 7m) 115V-60L/Hour
------------	---

Regulate the temperature of white and red wine from a single refrigeration unit!



BB900205



WINE FITTINGS



KEG COUPLERS

Part Number	Description
BB100992SS	TOF "D" System With 304SS Probe
BB100997SS	TOF "S" System With 304SS Probe
BB101004B-TS	TOF "Key Keg" System With 304SS Probe



BB100992SS



BB101004B-TS

FAUCETS

Part Number	Description
BB101228	316SS Euro Faucet With US Thread
BB101232	304SS Quix Faucet with US Thread
BB101246	Economy 304SS Faucet
BB101247	304SS Standard Domestic Style Faucet



BB101247



BB101232

GAS REGULATORS

Part Number	Description
CO882031C	C. 1P(30) CO ₂ Primary Regulator With Shut-Off
CO882031T	TR. 1P(30) CO ₂ Primary Regulator With Shut-Off
CO892030C	C. 1P(30) N ₂ Primary Regulator With Shut-Off
CO892030T	TR. 1P(30) N ₂ Primary Regulator With Shut-Off
CO881033C	C. 1P(30) Secondary Regulator With Shut-Off
CO881033T	TR. 1P(30) Secondary Regulator With Shut-Off



CO882031C



CO892030C

304SS SHANKS

Part Number	Description
BB101293-WW	304SS Shank Assembly With 1/4" Barb Elbow
BB101295-3SS	304SS 3 1/8" Shank Assembly - 1/4" Bore
BB101295-4SS	304SS 4 1/8" Shank Assembly - 1/4" Bore
BB101295-5SS	304SS 5 1/8" Shank Assembly - 1/4" Bore
BB101295-6SS	304SS 6 1/8" Shank Assembly - 1/4" Bore
BB101295-8SS	304SS 8 1/8" Shank Assembly - 1/4" Bore



BB101293-WW



BB101295 8SS

FITTINGS

Part Number	Description
QD100212	3/8" OD Equal Tee
BB101507SS	304SS 1/4" Barb Tailpiece
BB101532	304SS 1/4" 90° Barb Tailpiece
BB101496-SS	304SS Shut-Off Valve
MP551825	1/4" x 1/4" Barb Shut-Off
SF143325-X	304SS 1/4" x 1/4" x 1/4" Barb Tee
SF147725-X	304SS 1/4" x 1/4" Barb Splicer



BB101507SS



MP551825



FLOJET BIB PUMPS

Part Number	Description
MP555000	T-5000 Gas Operated Beverage Pump
MP555036-14	Bevjet II LF Electric Pump -115V
MP555027-015	3/8" OD Push In Fitting
KT000101	T-5000 Pump Kit with QCD, Clamp and 8' of BIB Tubing

BIB CONNECTORS

Part Number	Description
MP550002	Liqui-Box QCD II Bag-In-Box Connector
MP550035	Vitop Bag-In-Box Connector

BIB PUMP PANEL KITS

Part Number	Description
WW555111	1P Flojet BIB Pump Kit With C. 1P(100) Secondary Regulator
WW555122	2P Flojet BIB Pump Kit With C.1P(100) Secondary Regulator

CO₂ REGULATORS

Part Number	Description
CO881105C	C. 1P(100) Secondary Wall Mount Regulator
CO881165C	C. 1P(160) Secondary Wall Mount Regulator
CO882100CB	C. 1P(100) Primary Tank Mount Regulator
CO882160CB	C. 1P(160) Primary Tank Mount Regulator

SS GAUGE GUARD

Part Number	Description
CO898810-C	SS Gauge Guard for Cornelius Tank Mount Regulator
CO898810-T	SS Gauge Guard for Taprite/MMe Tank Mount Regulator



MP555000



MP555036-14



MP550002



MP550035



WW555122



CO881105C



CO898810-C

BIB RACKING



BIB RACKING

Part Number	Description
MP558998	1 Box Wide Incline BIB Rack
MP559000	2 Box Wide Incline BIB Rack
MP559003	3 Box Wide Incline BIB Rack

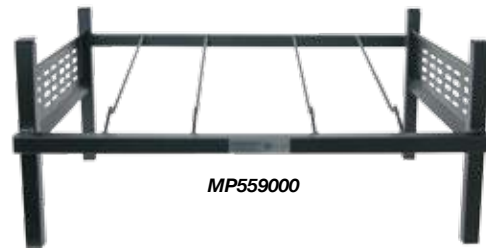

BIB TOP SHELVES

Part Number	Description
MP559010	1 Box Wide BIB Top Shelf
MP559011	2 Box Wide BIB Top Shelf
MP559012	3 Box Wide BIB Top Shelf



DUAL CORE WINE TRUNK LINE

Part Number	Description
BT040122	2 + 2 + 2 - 4L Dual Core Wine Trunk Line - 1/4" ID Barrier Product Tubes, 3/4" Wall Foam Insulation, Taped Jacket
BT060133	3 + 2 + 3 - 6L Dual Core Wine Trunk Line - 1/4" ID Barrier Product Tubes, 3/4" Wall Foam Insulation, Taped Jacket
BT080144	4 + 2 + 4 - 8L Dual Core Wine Trunk Line - 1/4" ID Barrier Product Tubes, 3/4" Wall Foam Insulation, Taped Jacket
BT100155	5 + 2 + 5 - 10L Dual Core Wine Trunk Line - 1/4" ID Barrier Product Tubes, 3/4" Wall Foam Insulation, Taped Jacket

Innovation at its finest! This unique insulated trunk line is fabricated with two individual cores; one with cold recirculation tubes to keep the white wines cold and the other without, so the reds can be maintained at warmer, optimal serving temperatures.



WINE TUBING

Part Number	Description	Color	Length
BT143900	1/4" ID x 3/8" OD Barrier	Natural	500'
BT144500	1/4" ID x 1/2" OD PVC Braid	Clear	100'
BT383250	1/4" ID x 3/8" KFLEX Barrier	Natural	100'
BT384900	5/16" ID x 7/16" OD Barrier	Natural	500'
BT385100	3/8" ID x 1/2" OD Barrier	Natural	500'
BT385804	5/16" ID x 9/16" OD Vinyl	Clear	100'
BT385818	5/16" ID x 9/16" OD Vinyl	Red	100'

Polyethylene Exterior
Barrier Coating



FLOW RESTRICTOR

Part Number	Description
MP551060	Flow Restrictor
MP551064	SS In-Line Flow Control 5/16" OD x 5/16" OD



COLD COFFEE TOWERS

3" COLUMN - AIR TAPS INCLUDED AS NOTED



Part Number	Taps	Faucet Style	Finish	Tubing	Drip Tray
JJ125402	1	304SS	Polished SS	KFLEX	10"
JJ125432	1	316SS Nitro	Polished SS	KFLEX	10"
JJ125452X	1	None	Polished SS	KFLEX	10"
JJ125406	2	304SS	Polished SS	KFLEX	10"
JJ125436	2	316SS Nitro	Polished SS	KFLEX	10"
JJ125456X	2	None	Polished SS	KFLEX	10"
JJ125419	3	304SS	Polished SS	KFLEX	10"
JJ125439	3	316SS Nitro	Polished SS	KFLEX	10"
JJ125459X	3	None	Polished SS	KFLEX	10"

To wrap graphics on a 3" Column tower add " -BR " to the end of the part number.



SEXY - AIR

Part Number	Taps	Finish	Tubing	Drip Tray
JJ102081A	1	Chrome	SS	10"
JJ102082A	2	Chrome	SS	10"
JJ102083A	3	Chrome	SS	12"

LIT SEXY - AIR

Part Number	Taps	Finish	Tubing	Drip Tray
JJ102085A	1	Chrome	SS	10"
JJ102086A	2	Chrome	SS	10"
JJ102087A	3	Chrome	SS	12"



MONGOOSE - AIR

Part Number	Taps	Finish	Tubing	Drip Tray
JJ102140A	1	Chrome	SS	10"
JJ102150A	2	Chrome	SS	10"
JJ102160A	3	Chrome	SS	12"

See SS tap selections on pages 32 & 33.

 MEDALLIONS & TAP HANDLES NOT INCLUDED
 TAPS SOLD SEPARATELY



TAP HANDLES

Part Number	Description
X933571-BR	Branded Natural Chalkboard Victory With Chrome Base
X919021-BR	Branded White Trap Z With Chrome Base
X920210W-BR	Branded White Round Conical With Chrome Base

COFFEE DISPENSING

KEGERATORS

Part Number	Description
JJ901032	1T Black Kegerator - Includes Standard 304SS Faucet
JJ901032-X2	2T Black Kegerator - Includes Standard 304SS Faucets



JJ901032



JJ901032-BR

BRANDED KEGERATORS

Part Number	Description
JJ901032-BR	Branded Door on JJ901032
JJ901032-3BR	Branded Door & Sides on JJ901032
JJ901032-X2BR	Branded Door on JJ901032-X2
JJ901032-X23BR	Branded Door & Sides on JJ901032-X2

DIRECT DRAW COLD COFFEE DISPENSERS

Part Number	Description
REX00024	KC24 1DR - No Tower & Less Tapping Kit
REX00024-BR	Branded Door on KC24 1DR - No Tower & Less Tapping Kit

Choose a tower from page 117 to complete your KC24



REX00024-BR

Shown with optional tower

TAPPING KITS

Part Number	Description
JJ801012-N2	N2 1T Tapping Kit
JJ801014-N2	N2 2T Tapping Kit
JJ801015-N2	N2 3T Tapping Kit
JJ801016-N2	N2 4T Tapping Kit

LID & DIFFUSION STONE

Part Number	Description
JJ320050	5M Diffusion Stone
JJ320062	2.5G Tank Lid W/Diffusion Stone
JJ320065	5G Tank Lid W/Diffusion Stone



JJ320050



MP099900
Shown with optional branding



MP099910

304SS TANKS

Part Number	Description
MP099900	A.E.B. Ball Lock 2.5G SS Tank
MP099910	A.E.B. Ball Lock 5G SS Tank

INDEX

A Adapters, Tower	24	Flushers	84	Picnic Cooler Parts	80
Air Distributors	71	FOB Detectors	67	Poly Tubing	49
Albatross Towers	21			Post-Mix Dispensers	100, 101
Apollo Towers	13	G Gas Blenders	71	Pre-Mix Tanks	103
B Back Bars	88	Gauges	74		
Bar Guns	98, 99	Gauge Guards	74	R Rail Towers	19
Bar Gun Parts	98, 99	Glass Door Merchandisers	89	Refrigerator Conversion Kits	75-77
Beer Check	71	Glass Rinsers	26, 27	Regulators-Post Mix	94, 95
Beer Pumps	67	Growler Filling Station	30	Regulators-Primary	73
Beer Switch	54	Glycol	48	Regulators-Secondary	68, 69
BIB Connectors	94	Glycol Power Packs	46, 47	Regulator Panels	68-70
BIB Pumps	92, 93	Glycol Power Pack Parts	46-48	Rinser Trays	14, 26-27
BIB Racks	94	Glycol Tester	48	Rinser Tray Parts	29
Blowers-Air Cooled	83	H Hand Trucks	90, 91	S Sexy Towers	6
Bottle Coolers	88	Hex Nuts	54	Shanks	
Bottled Water Dispenser	111	High Pressure Regulators	71, 73	Beer	35
Braided Tubing	49	Hose Nipples	55	Stainless	35
Brigitte Towers	13	Hose Splicers	54	Shield Towers	7
Brix Cup	97	I Ice Towers	6, 7, 8	Shut-Offs	54
Brushes	85	Iced Tea Dispenser	100	Space Mizer	22
Bulk Co2 Reserve Kit	74	Idea Towers	12	Splicers	54
Bundle Tubing	101	Insulation	48	Spout Caps	34
C Cable Ties	102	J Jockey Boxes	52, 78, 79	Spout Plug	34
Carbonators	93	JG Fittings	56-59	Stout Faucets	34
Changeover Valves	74	Juice Dispensers	101	T "T" Towers	17
Chemicals, Line Cleaning	83, 84	K Keg		Tango Tower	13
Chemicals, Glass Washing	84	Bumpers	91	Tap Handles	37-41
Chill-Max™ Cartridges	23, 31	Coolers	86	Tape	48
Clamp-On Tower Bracket	27	Couplers	60, 61	Thermometers	36
Clamp-On Towers	27, 53	Coupler Parts	62	Tools	34, 36
Clamps	55	Jackets	79, 91	Tower Parts	34, 35
Cleaning Equipment	85	Stackers	72	Trunk Line	50, 51
Cleaning Kits	85	Wrap	79, 91	Tube and Hose Fittings	54-59
Cold Block	48	Keg Pumps	81, 82	Tube Cutters	59
Cold Plates	80, 96	Kronos	22	Tubing	49
Column Towers	24	L Locks-Faucet	34	U Underbar Dispensers	22
Condor Towers	20	Lubricant-Probe	61	Unicorn Tower	100
Couplers	60, 61	Lucky Towers	7	V Vitop BIB Wine Connector	115
Coupler Parts	62	M Manifolds-Air	71	W Wall Brackets	55
Co2 Cylinders	77	Material Handling	90, 91	Wall Mount Drip Trays	28, 30
Cold Coffee	117, 118	Maxi Panther Towers	8	Washers	55, 62, 80, 82
D Direct Draw Dispensers	86	Medallions	42	Water Boosters	97, 111
Drip Trays	14, 25-28, 30	Medallion Holders	43-45	Water Cooling Equipment	109
Drip Tray Parts	29	Metro Towers	14, 15	Water Dispenser	109
Double Faucet Shanks	35	Modular Towers	19-21	Water Filters	110, 111
E Elbows	54-56, 58, 59	Monaco Towers	12	Water Pumps	111
F Faucets		Mongoose Towers	11	Water Regulators	96, 108
Beer	32, 33	Mushroom Towers	16	Water Tap Handles	107
Coffee	32, 117	N Nipples		Water Towers	104, 105, 106
Locks	34	Hose	55	Wine Cooling Equipment	113
Stout	32	Shanks	35	Wine Fittings	114
Water	108	P Panther Towers	8	Wine Pumps	115
Wine	33, 114	Party Pumps	81, 82	Wine Towers	112
Wrench	36	Pass Thru Towers	18	Wine Tubing	116
Fittings	54, 55	Picnic Coolers	52, 78, 79	Wrenches	36
Flash Coolers	52			Z Zeus Towers	10
Flow Control Faucets	32				
Flowmeters	72				

Draft
Doctor



Draft Doctor's Sales & Service Inc.
www.draft-doctor.com
604 992 6355